

DOORKING SYSTEMS

ACCESS CONTROL SOLUTIONS™

1830 SERIES NETWORK WORKSHOP

WAN APPLICATIONS

REV 04.11

WIDE AREA NETWORK (WAN) CONNECTION

- ☑ **Ethernet Connection:** An Ethernet Cable, or wireless connection must be provided between the 1830 Adaptor and the Router
- ☑ **Local Area Network, (LAN)** – The 1830 and Adaptor must be connected and active on the LAN. This requires the following information (See LAN Guide for details)
 - Router (Default Gateway) IP Address
 - IP Address for 1830 adaptor
- ☑ **Port Forwarding** – Within the Network Router (Gateway), the Port Number assigned to the Network Adaptor must be programmed to enable Port Forwarding (sometimes called “Virtual Server” in some routers). This must not conflict with other devices active within the LAN.
- ☑ **Gateway and Port Number Programming** – These must be programmed into the Adaptor
- ☑ **The ISP (Internet Service Provider) IP Address** – This will either be a Static IP Address or a Dynamic IP address (which can change periodically). If the ISP uses a Dynamic IP Address, you may want to register for a DDNS Host Service.

TCP/IP NETWORK CONNECTION OPTIONS

Network and Ethernet connectivity for our 1833, 1834, 1835 1837 and 1838 systems:

1830-175 TCP/IP Adaptor for Ethernet connections:

The 6.3 Software expands the connectivity options for all 1830 series systems. Connectivity options now include:

- **Local Area Network (LAN):** Communicate between PC and Entry System utilizing Ethernet Connection
- **Wide Area Network (WAN):** Communicate between PC and Entry System utilizing Internet Connection at PC and at Entry System.
- **Improved Communication Speeds:** Data Transfer entire database in around 1 ½ minutes.

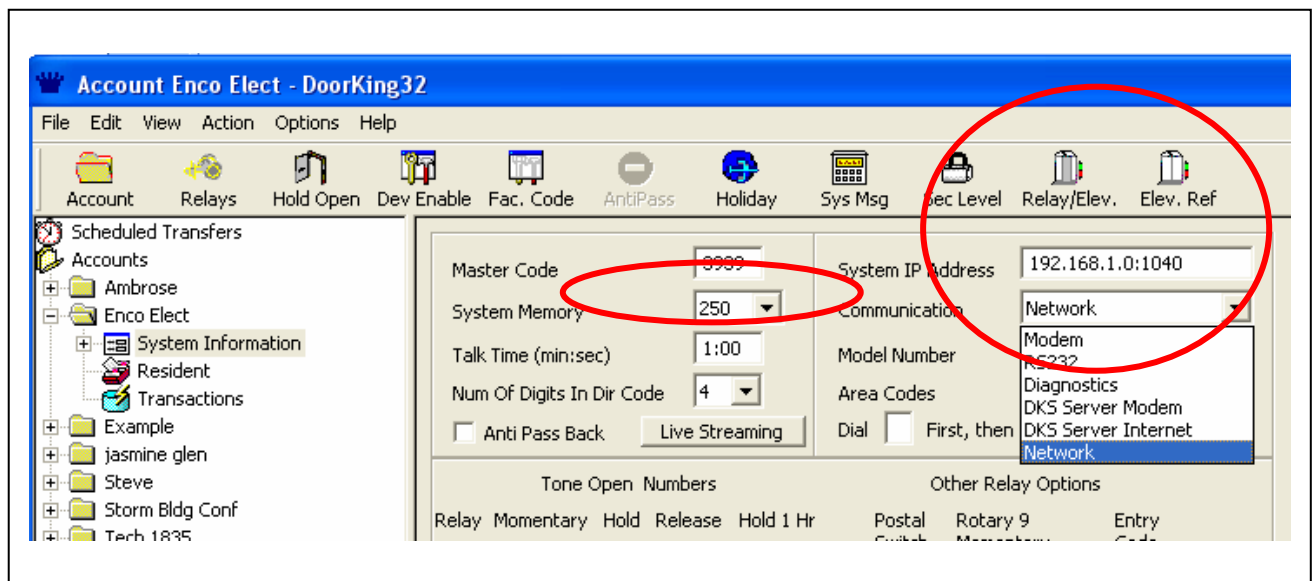

1830 SERIES WAN AND INTERNET CONNECTIONS

Model 1830-175 Network Adaptor: This training guide will focus on the TCP/IP Network interface for Wide Area Network (Internet) Connections

WIDE AREA NETWORK (WAN): This allows the 1830 series systems to be accessed from outside the LAN. Proper set up of the WAN connection is required for Remote Programming, Remote Control and Monitoring of the system relays.

REQUIREMENTS FOR A WAN APPLICATION:

- ☑ **Local Area Network, (LAN)** – The 1830 and Adaptor must be connected and active on the LAN. This requires the following information (See LAN Guide for details)
 - Router (Default Gateway) IP Address
- ☑ **Port Forwarding** – Within the Network Router (Gateway), the Port Number assigned to the Network Adaptor must be programmed to enable Port Forwarding (sometimes called “Virtual Server” in some routers). This must not conflict with other devices active within the LAN.
- ☑ **Gateway and Port Number Programming** – These must be programmed into the Adaptor
- ☑ **The ISP (Internet Service Provider) IP Address** – This will either be a Static IP Address or a Dynamic IP address (which can change periodically). If the ISP uses a Dynamic IP Address, you may want to register for a DDNS Host Service.

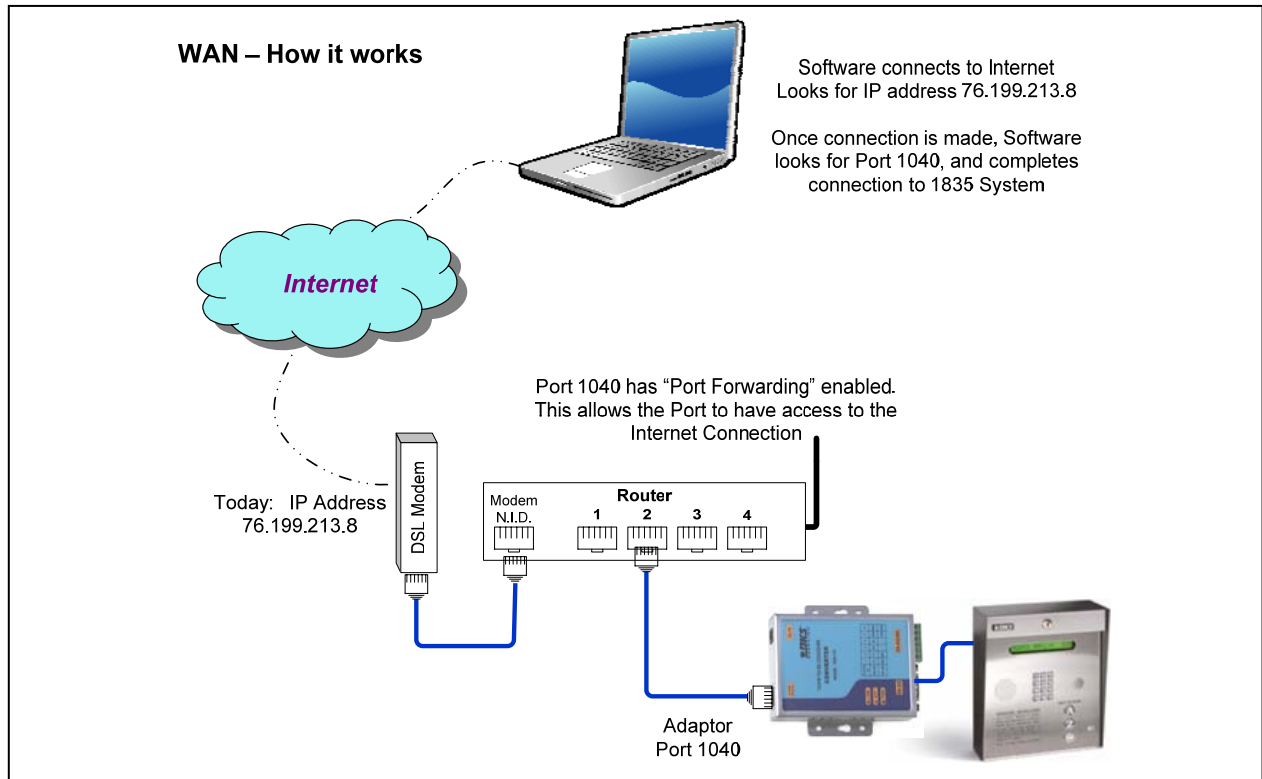

REGISTERING WITH THE LAN

LAN CONNECTIONS: (See the “LAN Guidelines”, or “Network Training Guide” for more details on setting up the Local Network Connections)

- ☑ **Registering with the LAN** – The Gateway Address must be programmed into the Network Adaptor. This allows the Adaptor to locate and register with the LAN. This is performed from a PC using Internet Explorer.
- ☑ **1830 IP Address** – The Adaptor must also have a unique IP address within the LAN. The default of 192.168.001.040 is typically available. However, if the Gateway Address utilizes a different number in the first 3 segments, for example: 192.168.2.1, this must be changed in the Adaptor.

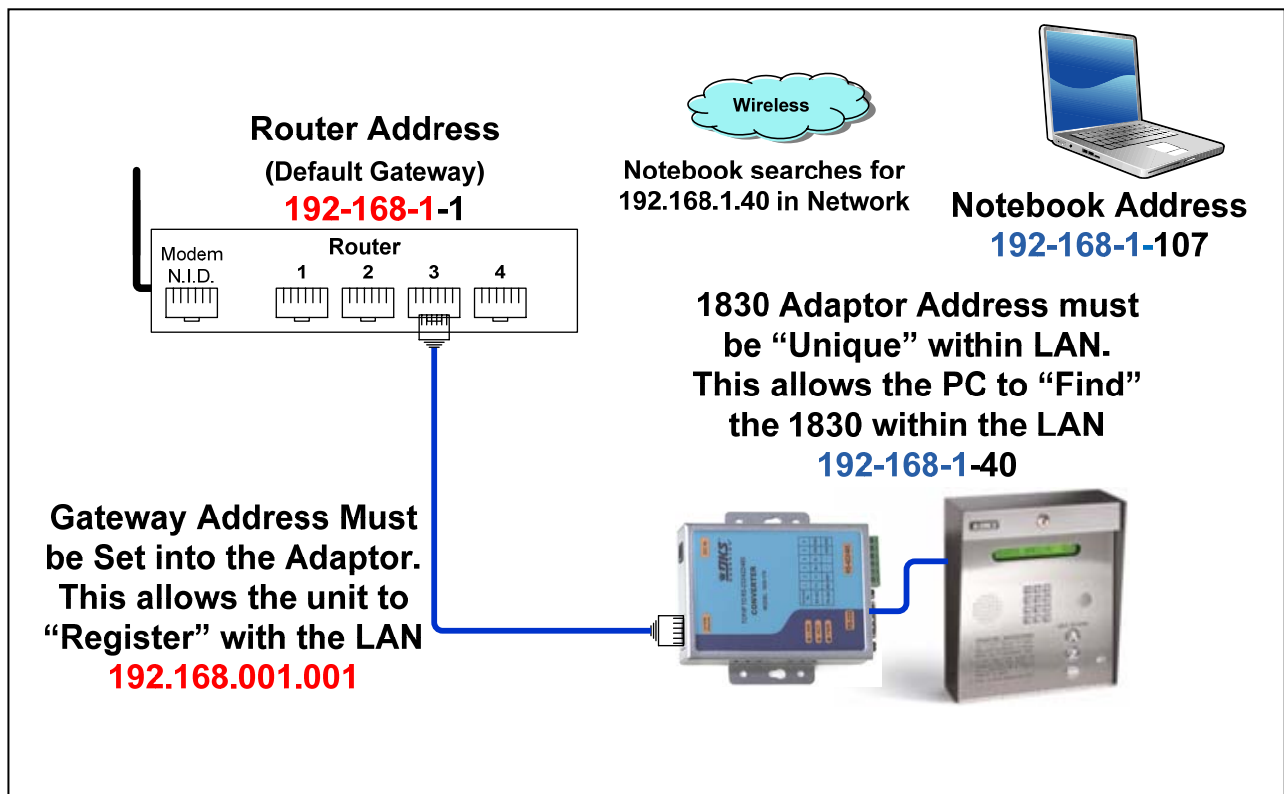

1830 SERIES – WAN CONNECTIONS (CONTINUED)

Once the system is active within the LAN, you will need to set up the Router to allow access between the “Port” and the Internet Service Provider connection.

- ☑ **Router Port Forwarding:** This will require entering into the Router Manager Software to set up the Port and IP address for the 1830 Adaptor.

BE CAUTIOUS WHEN WORKING IN ROUTER PROGRAMMING. WE RECOMMEND HAVING THE NETWORK ADMINISTRATOR PERFORM THESE PROGRAMMING FUNCTIONS

1. Open Internet Explorer. In the address line, type in the IP Address of the Router (Default Gateway Address).

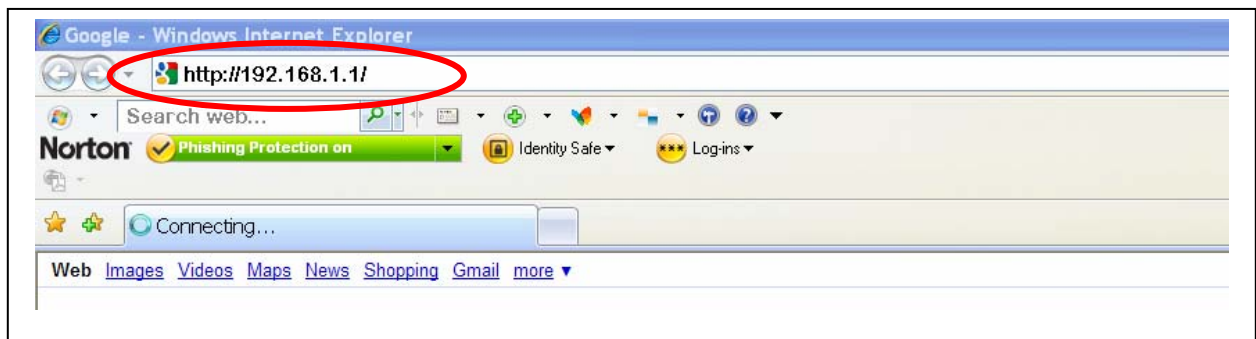

2. This will open an Authentication Window asking for the User Name and Password for the Router.

The default User Name and Password is typically listed on the identification label of the Router (bottom of Router).

A common default is as follows:

User Name: admin

Password: password

If this is an existing LAN, the User Name and Password have probably been changed. Contact the Network Administrator for Router Set Up.

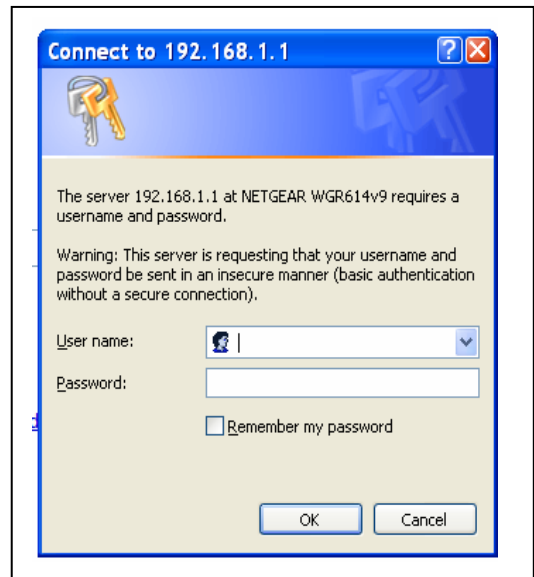

1830 SERIES – WAN CONNECTIONS (CONTINUED)

3. This will open the Router Manager software. Each Router brand may use different screens, or different terminology. The following are examples:

The first screenshot shows the Linksys Router Manager interface. The 'FORWARDING' tab is selected. A table lists service port ranges, protocols, and IP addresses. A 'Well-known Ports' list is also visible.

Service	Port Range	Protocol	IP Address
	1030 ~ 1030	Both	192.168.1.11
	0 ~ 23	Both	192.168.1.101
	1025 ~ 1025	Both	192.168.1.7
	1027 ~ 1027	Both	192.168.1.10
	0 ~ 0	Both	192.168.1.0
	0 ~ 0	Both	192.168.1.0
	0 ~ 0	Both	192.168.1.0

The second screenshot shows the D-Link Air Plus G 802.11g/2.4GHz Wireless Router interface. The 'Virtual Server' tab is selected. The 'Virtual Server' section is enabled. The configuration shows a name 'DK1812', private IP '192.168.1.10', protocol 'Both', private port '1025', and public port '1025'. A 'Virtual Servers List' table is also present.

Name	Private IP	Protocol	Schedule
<input type="checkbox"/> Virtual Server FTP	0.0.0.0	TCP 21/21	always
<input type="checkbox"/> Virtual Server HTTP	0.0.0.0	TCP 80/80	always
<input type="checkbox"/> Virtual Server HTTPS	0.0.0.0	TCP 443/443	always
<input type="checkbox"/> Virtual Server DNS	0.0.0.0	UDP 53/53	always

The third screenshot shows another router interface with a yellow theme. The 'VIRTUAL SERVER' tab is selected. The configuration shows a name 'KL2', incoming protocol 'TCP', incoming port '1027', forwarding IP '192.168.1.10', and forwarding port '1027'. The schedule is set to 'Everyday'.

Name	Enable	Proto/Port#	IP/Port#
SMTP	enable	TCP/25	192.168.1.11/25
POP3	disable	TCP/110	192.168.1.0/110

1830 SERIES – WAN CONNECTIONS (CONTINUED)

☑ **Setting up Router Port Forwarding:** (Continued) Depending upon the Router brand, this may be called Virtual Server.

4. Using the Netgear Router as an example... From the Router Manager, select “Port Forwarding”. Then click on Add Custom Service.

The screenshot shows the Netgear Router Manager interface in a Windows Internet Explorer browser window. The address bar shows `http://192.168.1.1/start.htm`. The page title is "NETGEAR SMARTWIZARD router manager Wireless-G Router model WGR614v9". The left sidebar contains a navigation menu with items like "Block Sites", "Schedule", "Router Status", "Attached Devices", "Backup Settings", "Set Password", "Router Upgrade", "Advanced", "Wireless Settings", "Wireless Repeating", "Port Forwarding / Port Triggering" (circled in yellow), "WAN Setup", "LAN Setup", "Dynamic DNS", "Static Routes", "Remote Management", "UPnP", and "Web Support". The main content area is titled "Port Forwarding / Port Triggering" and contains the following elements:

- A heading "Port Forwarding / Port Triggering".
- A section "Please select the service type" with two radio buttons: "Port Forwarding" (selected) and "Port Triggering".
- A "Service Name" field with a dropdown menu showing "Age-of-Empire".
- A "Server IP Address" field with input boxes for "192", "168", and "1", followed by an "Add" button.
- A table with columns: "#", "Service Name", "Start Port", "End Port", and "Server IP Address".
- Buttons for "Edit Service" and "Delete Service".
- A button for "Add Custom Service" (circled in red).

The right sidebar contains descriptive text about Port Triggering and Port Forwarding. The Windows taskbar at the bottom shows the Start button, the "NETGEAR Router - Wi..." window, and system tray icons including Norton and a 98% battery level.

1830 SERIES – WAN CONNECTIONS (CONTINUED)

Router Port Forwarding: (Continued)

- This may open an Authentication Window asking for the User Name and Password for the Router. Once you are into the Port screen, enter a Service Name (1835 for example, or 1835 Main Gate), Service Type (TCP), Port and IP address of 1830 Adaptor. Click “Apply”

NOTE: We recommend changing the Port from the default value of ‘1040’ to increase security. This Port Number must be programmed to match at the Router, in the DKS Software, and set in the 1830 Adaptor

The screenshot shows the Netgear SmartWizard router manager interface for a Wireless-G Router model WGR614v9. The left sidebar contains navigation options: Block Sites, Block Services, Schedule, Maintenance, Router Status, Attached Devices, Backup Settings, Set Password, Router Upgrade, Advanced, and Wireless Settings. The main content area is titled 'Ports - Custom Services' and contains the following fields:

- Service Name: 1812
- Service Type: TCP/UDP (dropdown)
- Starting Port: 1030 (range 1~65534)
- Ending Port: 1030 (range 1~65534)
- Server IP Address: 192, 168, 1, 30

Buttons for 'Apply' and 'Cancel' are located at the bottom of the form.

- This will bring you back to the Port Forwarding screen and should show the new “Service” with the 1835 set up.

The screenshot shows the Netgear SmartWizard router manager interface for a Wireless-G Router model WGR614v9. The left sidebar contains navigation options: Setup Wizard, Setup, Basic Settings, Wireless Settings, Content Filtering, Logs, Block Sites, Block Services, Schedule, Maintenance, Router Status, Attached Devices, Backup Settings, Set Password, and Router Upgrade. The main content area is titled 'Port Forwarding / Port Triggering' and contains the following fields:

- Please select the service type:
 - Port Forwarding
 - Port Triggering
- Service Name: Age-of-Empire (dropdown)
- Server IP Address: 192, 168, 1, [] (Add button)

A table displays the configured services:

#	Service Name	Start Port	End Port	Server IP Address
<input type="radio"/> 1	1812	1030	1030	192.168.1.30

Buttons for 'Edit Service', 'Delete Service', and 'Add Custom Service' are located at the bottom of the screen.

1830 SERIES – WAN CONNECTIONS (CONTINUED)

INTERNET CONNECTION: There are 3 methods of connecting through an Internet Service Provider:

STATIC IP ADDRESS: If the network is provided with a Static IP Address, this can be used for connection from outside the network, via the Internet

DYNAMIC IP ADDRESS: Typical Residential Internet Service. In this type of service, the IP Address changes periodically. Typically the address will remain constant until the Network or DSL Modem is reset, powered down or rebooted, or if there are extended periods with no activity on the internet connection. If you utilize this type of connection, you may need to re-program the IP address in the Software periodically to maintain connection with the 1830 Series Entry System.

DYNAMIC DNS HOST (DDNS) This is a service that you register for which tracks the changing IP address of the residential internet service. A “site name” is assigned to the residential internet service, much like an internet site name. The DKS software then searches for this site, and provides connection between the PC and the 1830 Series Entry System.

- ☑ **Static or Dynamic IP Address, Finding the IP Address:** There are many methods for identifying the current IP address of the network. Open your Internet Explorer and type in one of the following IP addresses:

- IPChicken.com

The image contains two screenshots of web browsers. The top screenshot shows the IPChicken website in a Mozilla Firefox browser window. The page title is "IP Chicken - Whats my IP address? ip address lookup - Mozilla Firefox". The address bar shows "http://ipchicken.com/". The website features a cartoon chicken logo and the text "iP CHICKEN Served fresh daily™". Below the logo, there are navigation links for "CURRENT IP", "SECURITY PORT SCAN", and "HELP". The main content area displays "Current IP Address" in a yellow box, with the IP address "77.213.140.3" in large blue text. Below this, there is a link "Add to Favorites" and two advertisements: "Ip Address Provider" and "Hosted IP Phone System". The bottom section of the page is titled "Advanced" and lists technical details: "Name Address: 207-213-140-3.ded.pacbell.net", "Remote Port: 39720", and "Browser: Mozilla/5.0 (Windows; U; Windows NT 5.1; en-US; rv:1.9.0.15) Gecko/2009101601 Firefox/3.0.15 (.NET CLR 3.5.30729)".

The bottom screenshot shows the CheckMyIP website in a Mozilla Firefox browser window. The page title is "check my ip, my ip, what is my ip, find ip - Mozilla Firefox". The address bar shows "http://checkmyip.com/". The website has a navigation menu with links for "home", "tools", "tech news", "linux man pages", and "contact". The main content area features the "CheckMyIP" logo and the text "Your local IP address is 77.213.140.3". Below this, there are two sections: "IP Scan" with the text "Scan your Network IP Free Network IP Scan. IP.Scan.Qualys.com" and "Static IP Service" with the text "Consumer & Business DSL Service. Contact A Sales Rep & Get DSL Now. www.Sonic.net".

- Checkmyip.com

1830 SERIES – WAN CONNECTIONS (CONTINUED)

Things to set up in the DKS Software for connecting via IP Address:

- **Master Code:** This needs to match what has been set at the 1835/37 system.
- **Network:** Select Network or DKS Server Internet as connection method
- **IP Address & Port:** This is the ISP Internet Address, plus the Port assigned to the 1830 adaptor. For Example: **67.223.2.268:1040**

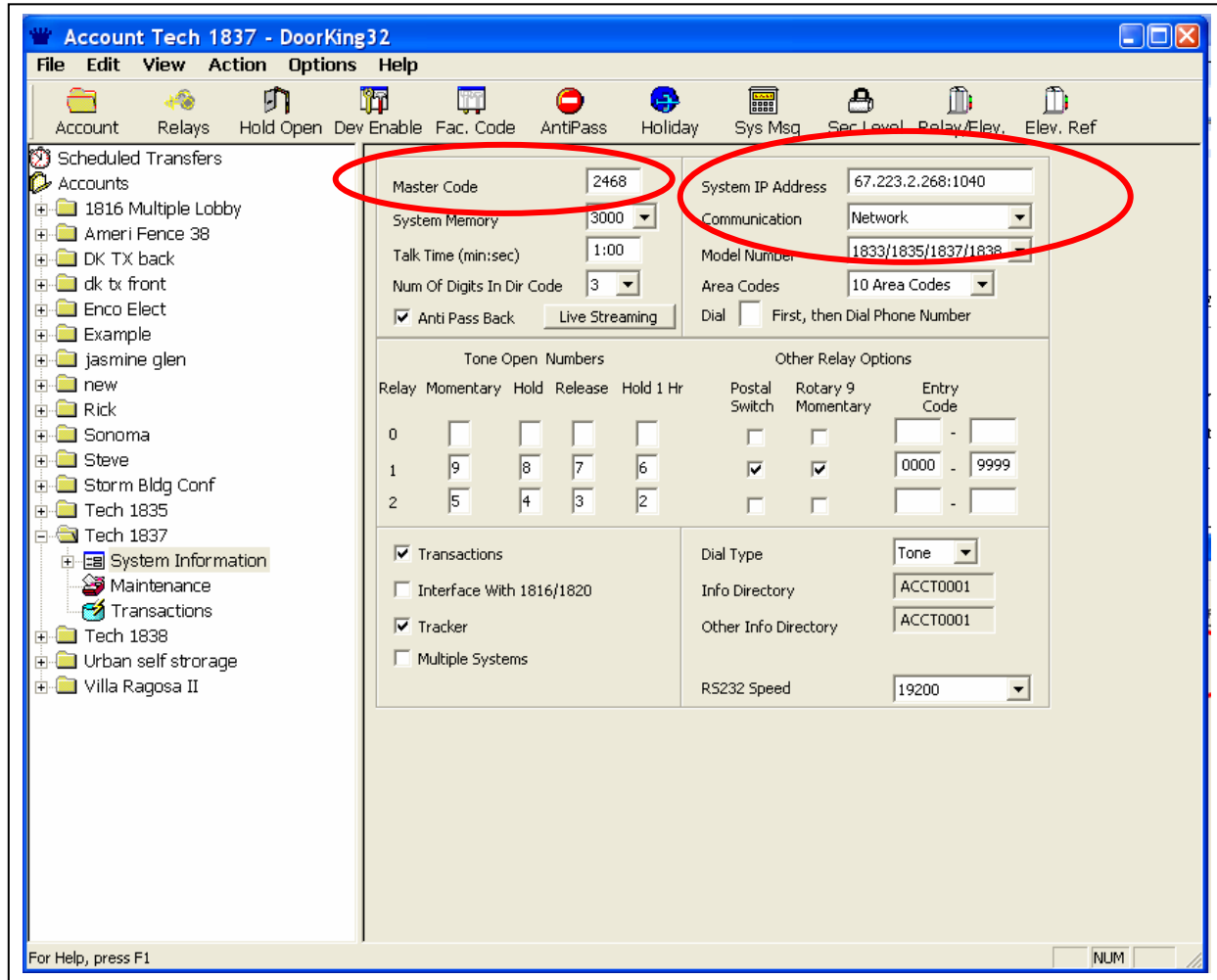

1830 SERIES – WAN CONNECTIONS (CONTINUED)

INTERNET CONNECTION UTILIZING DDNS HOST.

If the Network is not provided with a Static IP Address, it is recommended that you utilize a DDNS service provider to register the system IP Address.

What is DDNS?

Dynamic Domain Name Server. This is service that will track the IP Address of the Network when changes occur.

If the Router/Gateway is already set up with a DDNS Host for some other product or system, you can use the same DDNS service for connection to the Entry System Controller.

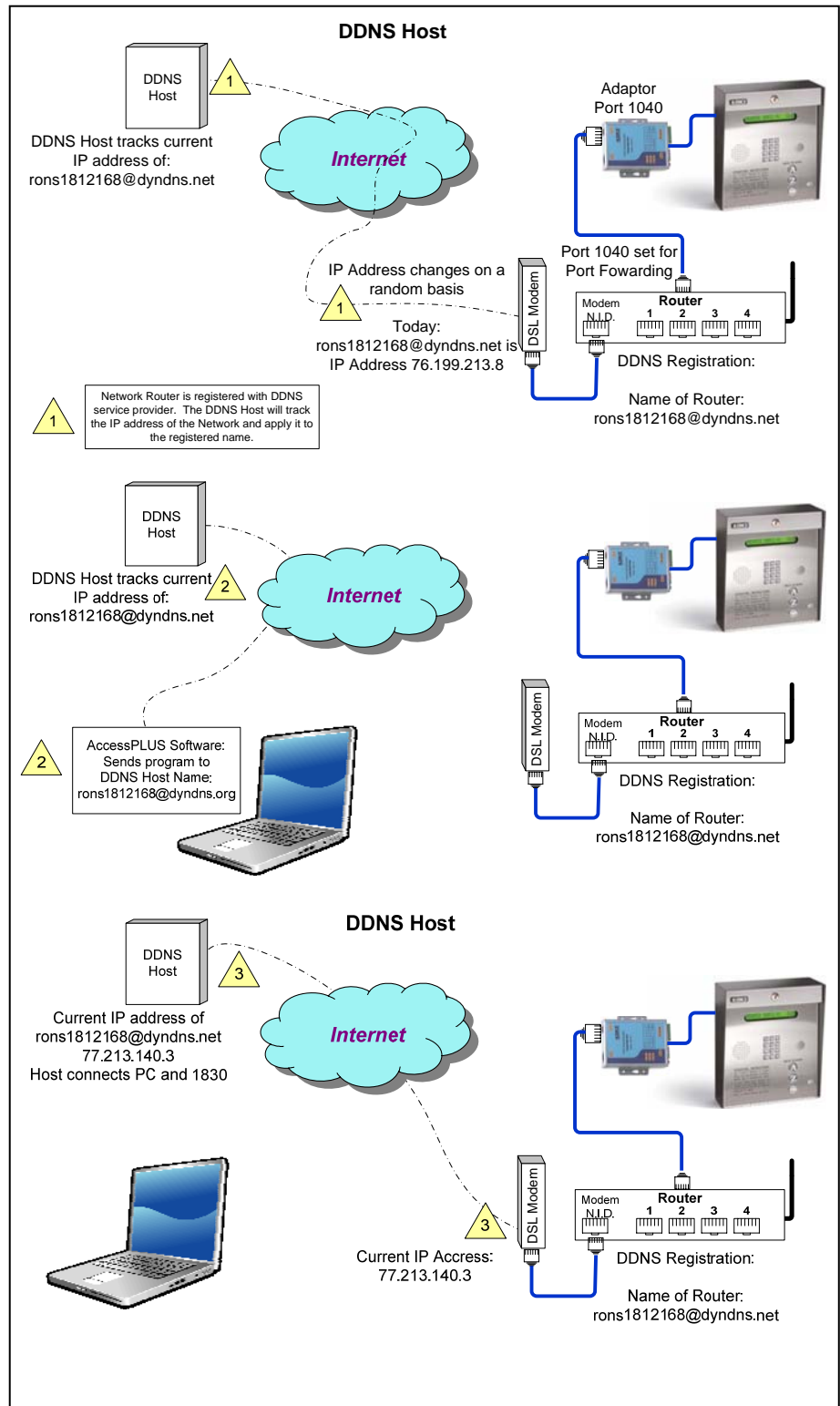

1830 SERIES – WAN CONNECTIONS (CONTINUED)

REGISTERING A DDNS NAME.

Most Routers will have a recommended DDNS Host Provider. This can be found in the Router documentation, or Router Manager. A common provider for many brands of Routers is: [dyndns.org](http://www.dyndns.org). This provider will host up to 5 DDNS accounts at no charge, as a complimentary service.

The following is an example of setting up a DDNS Host service.

From a PC on the Network connected to the 1812 System:

1. **DynDns.org:** Go to the Website and create an account. This should be in the Homeowners or Network Administrators name.

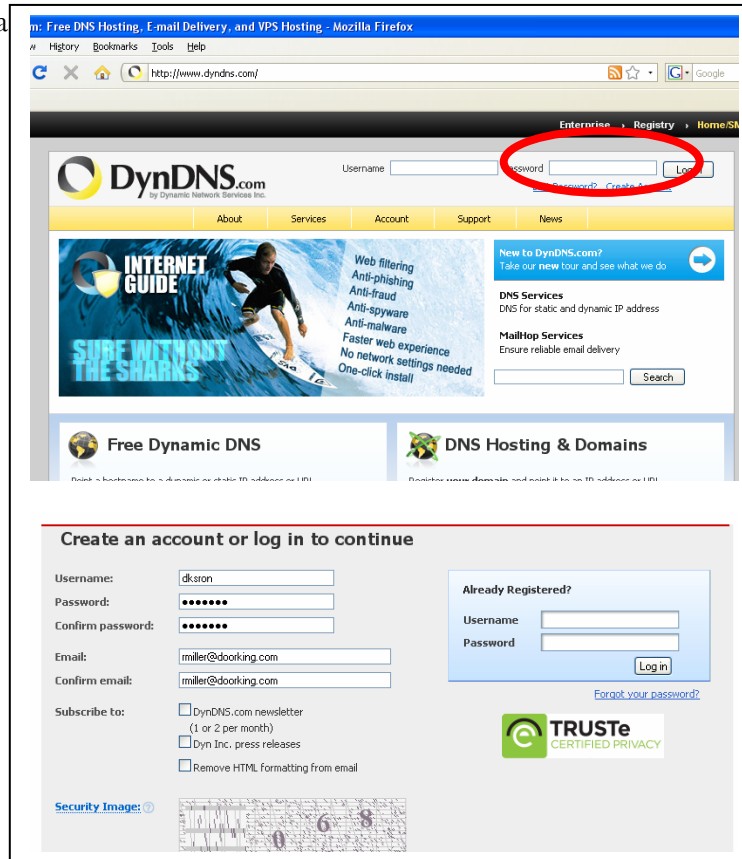

The screenshot shows the DynDNS.com website in a Mozilla Firefox browser. The browser address bar shows <http://www.dyndns.com/>. The website header includes navigation links for Enterprise, Registry, and Home/SA. The main content area features a navigation menu with About, Services, Account, Support, and News. Below the menu is a promotional banner for 'INTERNET GUIDE' with a surfer image and text: 'SURE WITHOUT THE SHARKS'. To the right of the banner are sections for 'New to DynDNS.com?' and 'DNS Services'. Below the banner are two main service categories: 'Free Dynamic DNS' and 'DNS Hosting & Domains'. The central focus is the 'Create an account or log in to continue' form. This form includes fields for Username (dkstrom), Password (masked with dots), Confirm password (masked with dots), Email (miller@doorking.com), and Confirm email (miller@doorking.com). There are also checkboxes for 'Subscribe to:' (DynDNS.com newsletter, Dyn Inc. press releases, and Remove HTML formatting from email). A 'Security Image' is displayed at the bottom left. On the right side of the form, there is an 'Already Registered?' section with fields for Username and Password, and a 'Log in' button. A 'Forgot your password?' link is also present. A 'TRUSTE CERTIFIED PRIVACY' logo is located at the bottom right of the form area.

2. **Add a Host Service:** This will set up a DDNS Hosting Service for the network of the 1812 system.

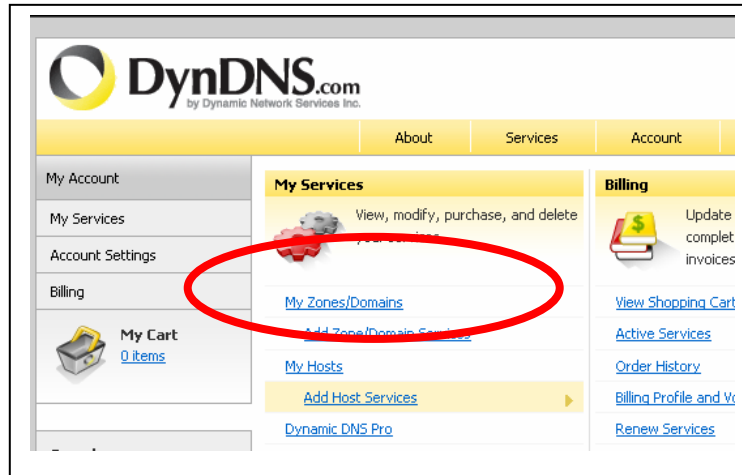

The screenshot shows the DynDNS.com website in a browser. The browser address bar shows <http://www.dyndns.com/>. The website header includes navigation links for About, Services, and Account. The main content area features a navigation menu with My Account, My Services, Account Settings, Billing, and My Cart. Below the menu is a 'My Services' section with a red gear icon and the text 'View, modify, purchase, and delete'. The 'My Services' section includes links for 'My Zones/Domains', 'Add Zone/Domain Services', 'My Hosts', 'Add Host Services', and 'Dynamic DNS Pro'. A red circle highlights the 'Add Host Services' link. To the right of the 'My Services' section is a 'Billing' section with a red dollar sign icon and the text 'Update complete invoices'. The 'Billing' section includes links for 'View Shopping Cart', 'Active Services', 'Order History', 'Billing Profile and V...', and 'Renew Services'.

1830 SERIES – WAN CONNECTIONS (CONTINUED)

REGISTERING A DDNS NAME (continued)

3. **Add New Hostname:** This is where you will create your DDNS Host information.
 - Select a “Host name”: We suggest using something related to the system
 - Select “dyndns.org” from host listing.
 - Service Type: “Host with IP Address”
 - IP Address: “Use the Auto Detected IP Address”. This will find the current IP Address of your network.
 - Click on “Add To Cart”

The screenshot shows a web browser window with the address bar displaying <https://www.dyndns.com/account/services/hosts/add.html>. The page title is "DynDNS.com - My Account -- Host Services -- Settings - Mozilla Firefox". The browser's menu bar includes Edit, View, History, Bookmarks, Tools, and Help. The address bar also shows navigation icons and a star icon.

The page content includes the DynDNS.com logo and a navigation menu with links for About, Services, Account, Support, and News. A sidebar on the left lists various services under "My Account" and "My Services".

The main content area is titled "Add New Hostname" and contains the following form fields:

- Hostname:** A text input field containing "rons1812168" and a dropdown menu set to "dyndns.org".
- Wildcard Status:** A text input field containing "Disabled" with a link "[Want Wildcard support?]" next to it.
- Service Type:** Three radio button options: "Host with IP address [?]" (selected), "WebHop Redirect [?]", and "Offline Hostname [?]".
- IP Address:** A text input field containing "77.213.140.3" with a link "[Use auto detected IP address: 77.213.140.3;]" below it. Below the IP field, it says "TTL value is 60 seconds. [Edit TTL]."
- Mail Routing:** A checkbox labeled "Yes, let me configure Email routing. [?]" which is currently unchecked.

An "Add To Cart" button is located at the bottom right of the form.

1830 SERIES – WAN CONNECTIONS (CONTINUED)

REGISTERING A DDNS NAME (continued)

4. **Confirm Order:** Depending upon the DDNS Host Provider, this often will be a complimentary service, provided at No Charge. This Host information must now be programmed into the Network Router.

The image shows two screenshots of the DynDNS.com website. The top screenshot displays the 'Shopping Cart' page. The user is logged in as 'dksron'. The cart contains one item: 'rons1812168.dyndns.org' for \$0.00. A message states 'rons1812168.dyndns.org added to cart. You must checkout to activate.' The page also features 'Upgrade Options' for Dynamic DNS Pro and a table of 'Dynamic DNS Hosts'.

The bottom screenshot displays the 'Host Services' page. The user is logged in as 'dksron'. A message states 'rons1812168.dyndns.org successfully activated.' Below this is a table with the following data:

Hostname	Service	Details	Last Updated
rons1812168.dyndns.org	Host	207.213.140.3	Nov. 24, 2009 6:04 PM

1830 SERIES – WAN CONNECTIONS (CONTINUED)

REGISTERING A DDNS NAME (continued)

5. **DDNS Set Up in Router:** From a PC on the Network, log onto the Router Manager using Internet Explorer. Go to the Dynamic DNS page. Program the required information.
6. **Click “Apply” to complete the Router programming.**

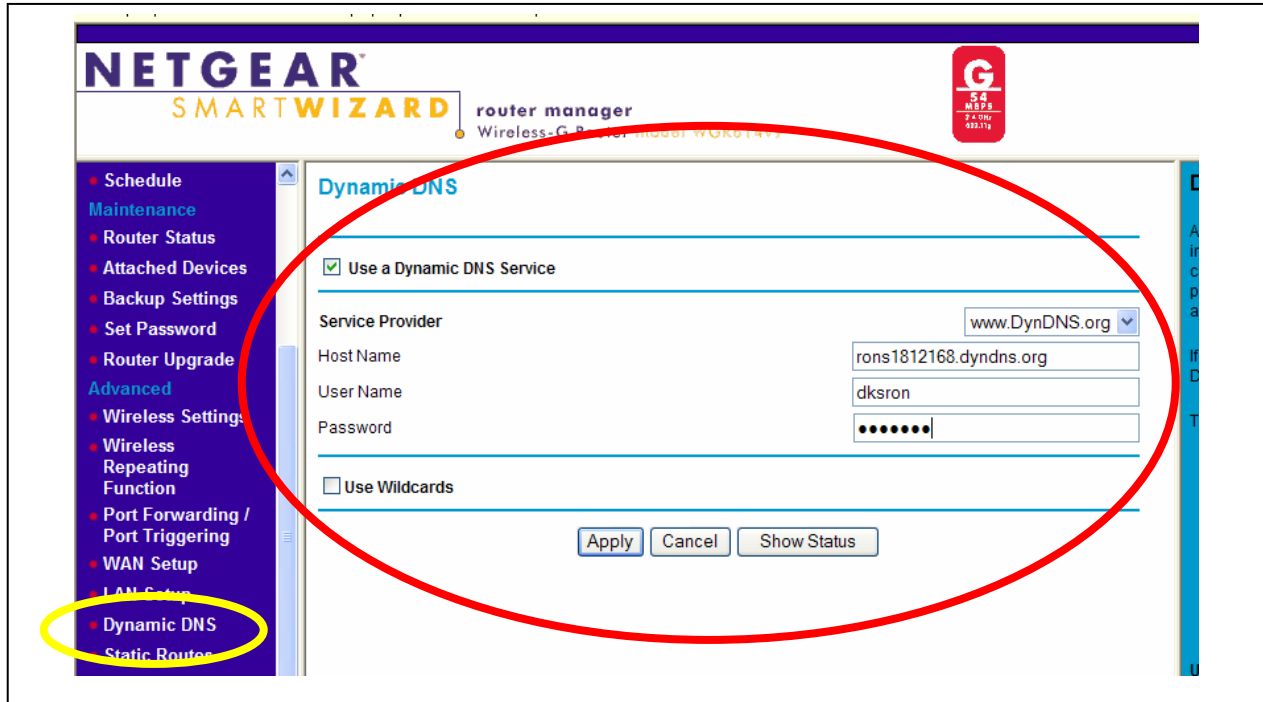

7. **AccessPLUS Software:** In the System Information screen, select either “Network” or “DKS Server Internet” (this option allows DoorKing to send you notice on product updates).. Enter your Host name followed by the Port Number:

Example: **Rons1835.dyndns.net:1040**

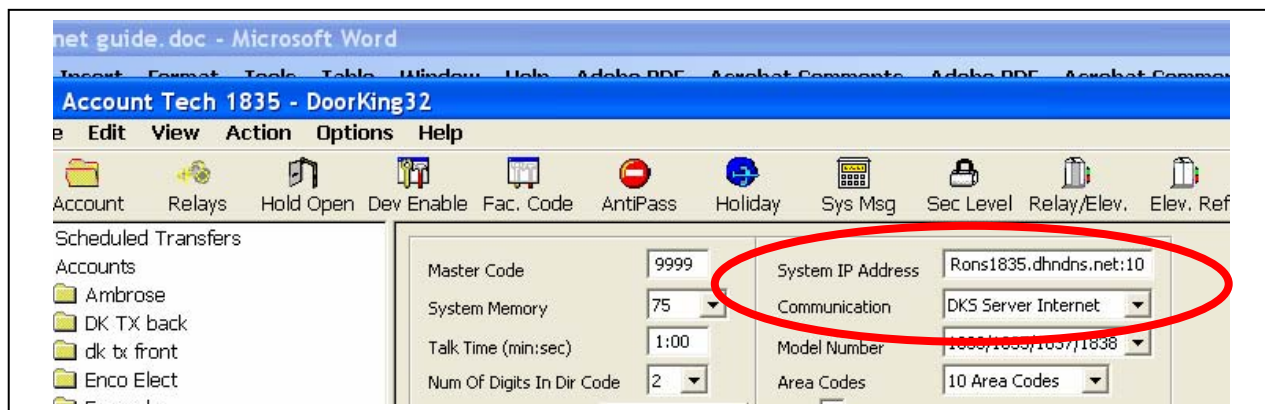

1830 SERIES – WAN CONNECTIONS (CONTINUED)

Testing the Connection through the DKS Software: From a PC at a remote location, with a separate internet service connection, try connecting with the 1830 series controller..

- ☑ Select an account, then click on the “View” menu.
- ☑ Select “Live Transactions” and click on the account you wish to test. Click “OK”

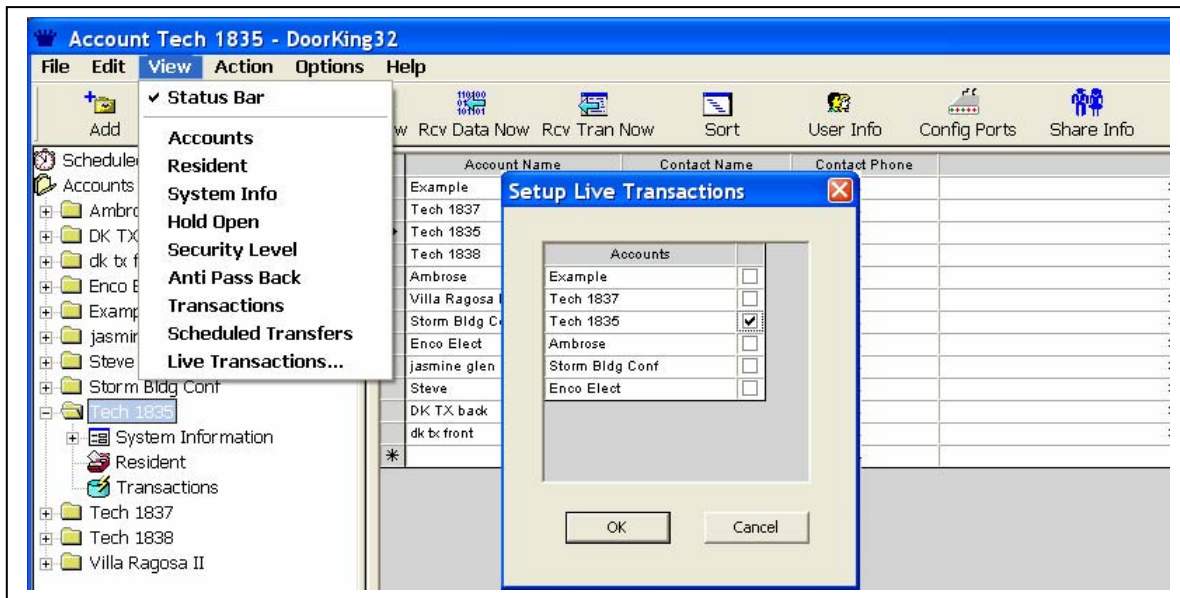

- ☑ This will open a Live Transaction Window. The first transaction should show: “Connection”. If you see a “Failed To Connect” message, the system is not registered and active within the LAN.



1830 SERIES – DIRECT CONNECTION OPTIONS

DIRECT CONNECTION OPTIONS FOR 6.0 SOFTWARE: (UPDATED INFO)

On-Site Programming, from a Local PC. In some applications, the entry system is not provided with a Telephone Line. This typically is seen in applications where the Controller is only providing Card Access functions, with no Visitor Call features. You may also have an application where the local computer does not have a dial up modem available, or where the customer prefers connecting to the Entry System without going through a Dial-Up Modem.

There are a few options available for programming through a “Direct Connection”:

- ❑ **RS-232 Hard Wired connection** - Requires a 5-Cond, shielded cable. Typically this hard wired connection should be run less than 50'-100'.

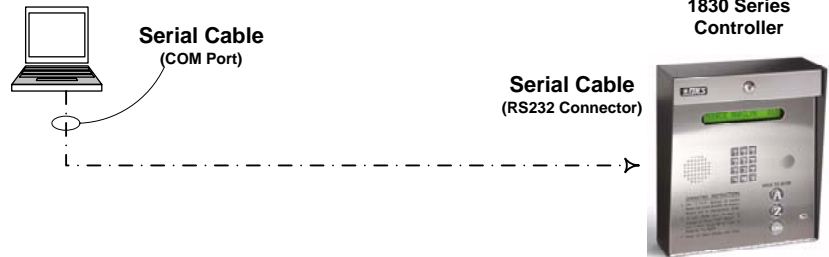

- ❑ **RS-232 to RS-422** - This converts the RS-232 signal, allowing hard wired runs up to 4,000'. Requires 2 twisted pairs plus a 5th conductor. Recommend CAT 5 Cable.

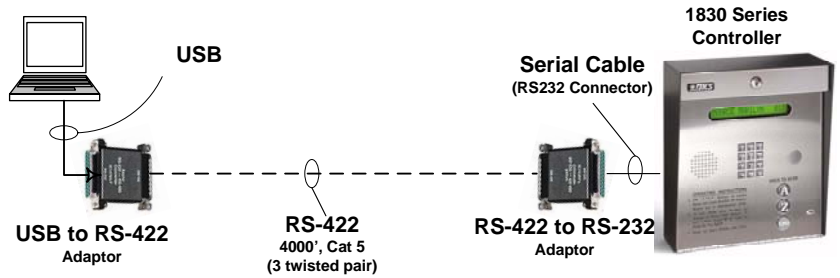

- ❑ **Wireless RS-232** - An adaptor converts the RS-232 Transmitting wireless for extended distances (Line of sight). Converter at the controller connects to Controller. Power required for both converters.

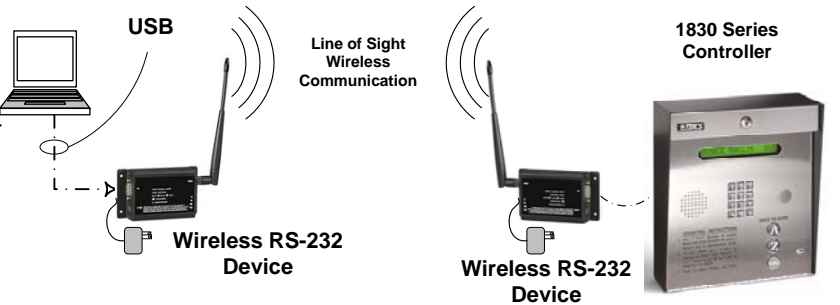

The Wireless and RS-422 conversions require installation of some drivers into the PC, and some pre-programming of the adaptors. These will be stocked and pre-programmed by DoorKing, and installation instructions will be developed for Dealers to install these items into their clients PC.

This Page Blank