

# Wiring / Owner's Manual

# Solar Control Box for

6003, 6004, 6005 and 6400 gate operators

Use this manual for circuit board 4302-018 Revision A or higher.

4302-067-B-7-18

Entrapment Protection must be provided for the gate system where the risk of entrapment or obstruction exists. The operator will NOT run without one or more monitored type B1 or B2 entrapment protection devices in EACH entrapment area.

**UL 325 August 2018 Standard**

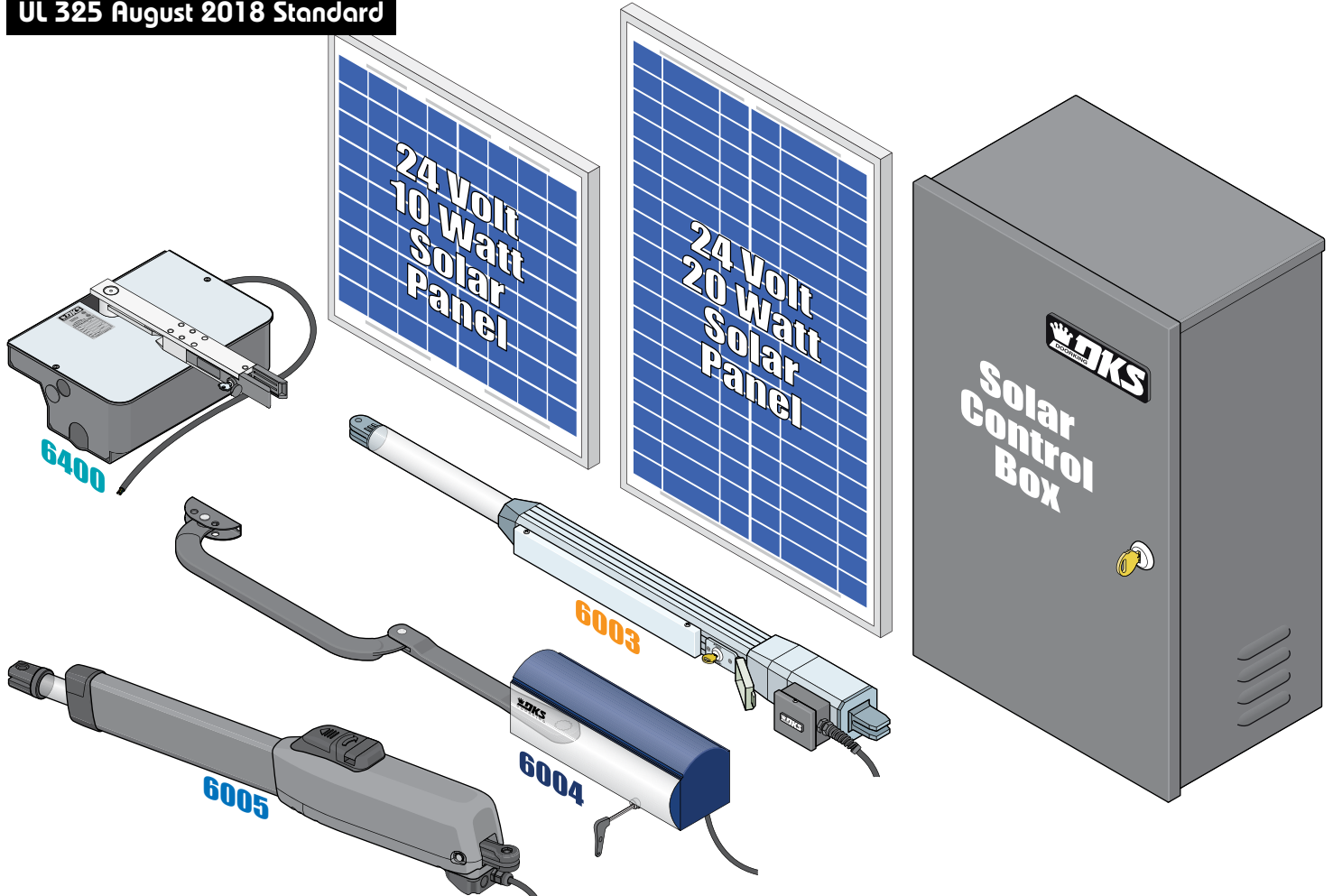

**THIS PRODUCT IS TO BE INSTALLED AND SERVICED BY A TRAINED GATE SYSTEMS TECHNICIAN ONLY.**  
Visit [www.dkslocator.com](http://www.dkslocator.com) to find a professional installing and servicing dealer in your area.

Date Installed: \_\_\_\_\_

Installer/Company Name: \_\_\_\_\_

\_\_\_\_\_

Phone Number: \_\_\_\_\_

Circuit Board  
Serial Number  
and Revision Letter: \_\_\_\_\_

**Leave Manual with Owner**

Copyright 2018 DoorKing, Inc. All rights reserved.



Conforms To UL STD 325  
Certified To CSA STD C22.2 # 247





# SOLAR CONTROL BOX SPECIFICATIONS

<b>Class of Operation</b>	Models 6003, 6004, 6005 and 6400 - UL325 Class I
<b>Type of Gate</b>	Residential Vehicular Automated Gates Only
<b>Voltage / Phase</b>	24 Volt Solar Input Power – 24 VDC Output Power to Gate Operators
<b>Battery Capacity</b>	Two - 12 Volt 18 Amp/Hour Dry Cell OR Two - 12 Volt 35 Amp/Hour Dry Cell
<b>Solar Panel Voltage</b>	24 Volt 10 Watt for 18 Amp/Hour Dry Cells OR 24 Volt 20 Watt for 35 Amp/Hour Dry Cells
<b>Circuit Board Model</b>	4302-018 revision A or higher.
<b>Inherent Entrapment Protection Device</b>	Inherent Reverse Sensor System (Type A)
<b>External Entrapment Protection Device Inputs</b>	Monitored input connection for Non-contact Sensor - Photo Sensor (Type B1) Monitored input connection for Contact Sensor - Reversing Edge (Type B2)

**Entrapment Protection must be provided for the gate system where the risk of entrapment or obstruction exists. The operator will not run without one or more monitored type B1 or B2 entrapment protection devices in EACH entrapment area.**

## 18 Amp/Hr Control Box

P/N 4302-114

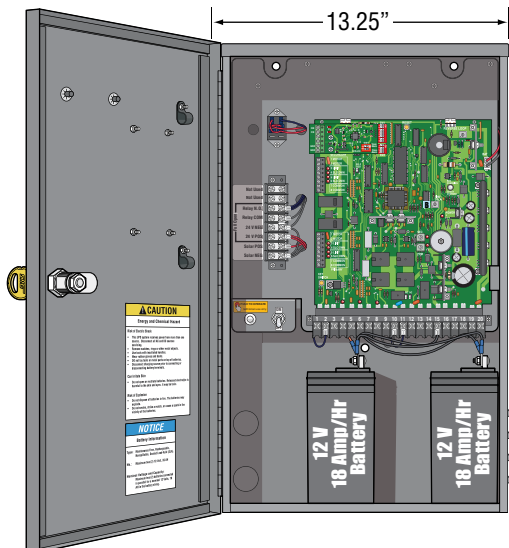

## No Batteries Control Box

P/N 4302-113

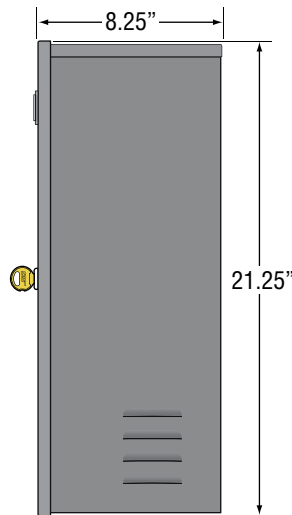

## 35 Amp/Hr Control Box

P/N 4302-115

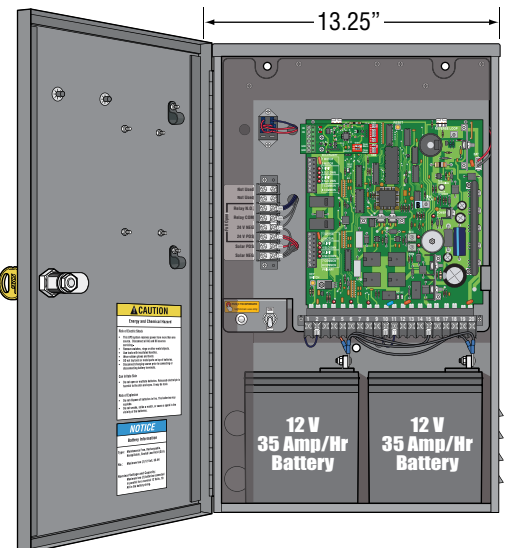

### Optional 24 Volt 10 Watt Solar Panel only for 18 Amp/Hr Batteries

P/N 2000-077

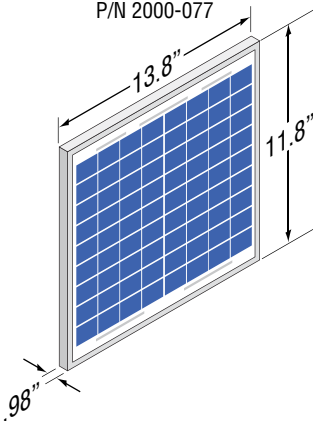

### Optional 24 Volt 20 Watt Solar Panel only for 35 Amp/Hr Batteries

P/N 2000-076

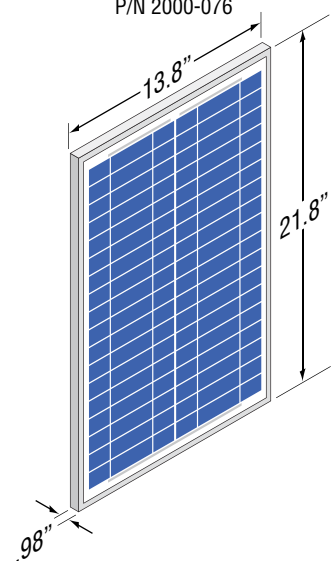

### Optional Mounting Post Kit for Control Box

P/N 1000-045

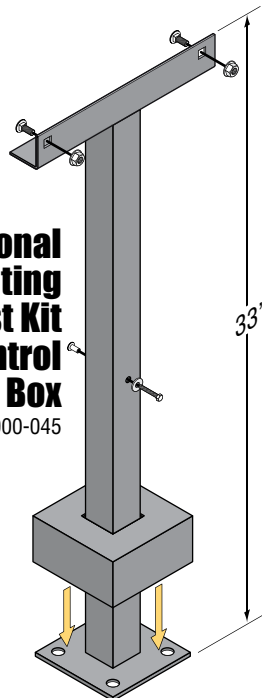

**Type of wiring to be used on ALL external devices:**  
**A) Type CL2, CL2P, CL2R, or CL2X.**  
**B) Other cable with equivalent or better electrical, mechanical, and flammability ratings.**

DoorKing, Inc. reserves the right to make changes in the products described in this manual without notice and without obligation of DoorKing, Inc. to notify any persons of any such revisions or changes. Additionally, DoorKing, Inc. makes no representations or warranties with respect to this manual. This manual is copyrighted, all rights reserved. No portion of this manual may be copied, reproduced, translated, or reduced to any electronic medium without prior written consent from DoorKing, Inc.

# TABLE OF CONTENTS

## **SPECIFICATIONS 1**

Solar Control Box Specifications	1
ASTM F2200 Standard for Gate Construction	3
Important Safety Instructions	3
Instructions regarding intended installation:	3-4
Important Notices	4
UL 325 Entrapment Protection	5
Glossary	6
Swing Gate Requirements	7
Swing Gate Protection	8

## **SECTION 1 - SOLAR PANEL INSTALLATION CONSIDERATIONS 9**

1.1 Solar Panel Concerns BEFORE Installation	9
1.2 Solar Panel Positioning	10

## **SECTION 2 - WIRING 11**

2.1 Control Box Wiring Overview	11
2.2 Wiring Operators to 4302 Circuit Board	12
2.3 Entrapment Protection Wiring	13
2.4 Full Open Terminal Wiring	14
2.5 Loop Detector Wiring	15
2.6 Battery Wiring	16
2.7 Solar Panel Wiring	17

## **SECTION 3 - ADJUSTMENTS 18**

3.1 3402 Circuit Board Description and Adjustments	18
3.2 DIP-Switches	19-20
3.3 Limit Sensors Adjustment - Select your specific operator	21-24
6003 Limit Sensors ONLY	21
6004 Limit Sensors ONLY	22
6005 Limit Sensors ONLY	23
6400 Limit Sensors ONLY	24
3.4 Inherent Reverse Sensor Adjustment	25
3.5 Shutdown Conditions	26-27
Soft Shutdown	
Hard Shutdown (Alarm Activated)	

## **SECTION 4 - MAINTENANCE AND TROUBLESHOOTING 28**

4.1 Maintenance	28
4.2 Diagnostics Check	28-29
4.3 Troubleshooting	29-30
4.4 Accessory Items	31
Solar Control Box Schematics	32

## **IMPORTANT INFORMATION FOR OWNER 33**

Shut-Off Power to Operator OR Shut-Off Alarm	33
Manually Operating the Gate - NO Power	34

# ASTM F2200 Standard for Gate Construction

Vehicular gates should be constructed and installed in accordance with ASTM F2200; Standard Specification for Automated Vehicular Gate Construction. For a copy of this standard, contact ASTM directly at 610-832-9585; service@astm.org; or www.astm.org.

## Important Safety Instructions

### **WARNING - To reduce the risk of injury or death:**

1. READ AND FOLLOW ALL INSTRUCTIONS.
2. Never let children operate or play with gate controls. Keep the remote control away from children.
3. Always keep people and objects away from gate. **NO ONE SHOULD CROSS THE PATH OF THE MOVING GATE.**
4. Test the operator monthly. The gate **MUST** reverse on contact with a rigid object or stop or reverse when an object activates the non-contact sensors. After adjusting the force or the limit of travel, retest the gate operator. Failure to adjust and retest the gate operator properly can increase the risk of injury or death.
5. Use the emergency release only when the gate is not moving.
6. **KEEP GATES PROPERLY MAINTAINED.** Read the owner's manual. Have a qualified service person make repairs to gate hardware.
7. The entrance is for vehicles only. Pedestrians must use separate entrance.
8. **SAVE THESE INSTRUCTIONS!**

## Instructions regarding intended installation:

- Install the gate operator only if:
  1. The operator is appropriate for the construction of the gate and the usage class of the gate.
  2. All openings of a horizontal slide gate are guarded or screened from the bottom of the gate to a minimum of 6 feet (1.83 m) above the ground to prevent a 2 ¼ inch (57.2 mm) diameter sphere from passing through the openings anywhere in the gate, and in that portion of the adjacent fence that the gate covers in the open position.
  3. All exposed pinch points are eliminated or guarded.
  4. Guarding is supplied for exposed rollers.
- The operator is intended for installation only on gates used for vehicles. Pedestrians must be supplied with a separate access opening. The pedestrian access opening shall be designed to promote pedestrian usage. Locate the gate such that persons will not come in contact with the vehicular gate during the entire path of travel of the vehicular gate.
- The gate must be installed in a location so that enough clearance is supplied between the gate and adjacent structures when opening and closing to reduce the risk of entrapment. Swinging gates should not open into public access areas.
- The gate must be properly installed and work freely in both directions prior to the installation of the gate operator. Do not over-tighten the operator clutch, pressure relief valve or reduce reversing sensitivity to compensate for a damaged gate.
- For gate operators utilizing Type D protection:
  1. The gate operator controls must be placed so that the user has full view of the gate area when the gate is moving.
  2. A warning placard shall be placed adjacent to the controls.
  3. An automatic closing device (such as a timer, loop sensor, or similar device) shall not be employed.
  4. No other activation device shall be connected.
- Controls intended for user activation must be located at least six feet (6') away from any moving part of the gate and where the user is prevented from reaching over, under, around or through the gate to operate the controls. Outdoor or easily accessible controls should have a security feature to prevent unauthorized use.
- The Stop and/or Reset button must be located in the line-of-sight of the gate. Activation of the reset control shall not cause the operator to start.
- A minimum of two (2) **WARNING SIGNS** shall be installed, one on each side of the gate where easily visible.
- For gate operators utilizing a non-contact sensor:
  1. See the instructions on the placement of non-contact sensors for each type of application.
  2. Care shall be exercised to reduce the risk of nuisance tripping, such as when a vehicle trips the sensor while the gate is still moving in the opening direction.
  3. One or more non-contact sensors shall be located where the risk of entrapment or obstruction exist, such as the perimeter reachable by a moving gate or barrier.
- For gate operators utilizing contact sensors:
  1. One or more contact sensors shall be located where the risk of entrapment or obstruction exist, such as at the leading edge, trailing edge, and post mounted both inside and outside of a vehicular horizontal slide gate.
  2. One or more contact sensors shall be located at the bottom edge of a vehicular vertical lift gate.
  3. One or more contact sensors shall be located at the pinch point of a vehicular vertical pivot gate.
  4. A hardwired contact sensor shall be located and its wiring arranged so that the communication between the sensor and the gate operator is not subjected to mechanical damage.
  5. A wireless contact sensor such as one that transmits radio frequency (RF) signals to the gate operator for entrapment protection functions shall be located where the transmission of the signals are not obstructed or impeded by building structures, natural landscaping or similar obstructions. A wireless contact sensor shall function under the intended end-use conditions.
  6. One or more contact sensors shall be located at the bottom edge of a vertical barrier (arm).
- Be sure you have instructed the owner of the gate operator about safe and proper operation and testing of the gate operator.

# Important Notices

Vehicular gate operator products provide convenience and security. However, gate operators must use high levels of force to move gates and most people underestimate the power of these systems and do not realize the potential hazards associated with an incorrectly designed or installed system. These hazards may include:

- Pinch points
- Entrapment areas
- Reach through hazards
- Absence of entrapment protection devices
- Improperly located access controls
- Absence of vehicle protection devices
- Absence of controlled pedestrian access

In addition to these potential hazards, automated vehicular gate systems must be installed in accordance with the UL 325 Safety Standard and the ASTM F2200 Construction Standard. Most people are unaware of, or are not familiar with, these standards. If an automated vehicular gate system is not properly designed, installed, used and maintained, serious injuries or death can result. Be sure that the installer has instructed you on the proper operation of the gate and gate operator system.

Be sure that the installer has trained you on proper and safe operation of this gate operating system and about the basic functions of the required reversing systems associated with your gate operating system and how to test them. These include reversing loops, inherent reversing system, electric edges, photoelectric cells, or other external devices.

- This Owner's Manual is your property. Keep it in a safe place for future reference.
- Be sure that all access control devices are installed a minimum distance of 6 feet away from the gate and gate operator, or in such a way that a person cannot touch the gate or gate operator while using the device. If access control devices are installed in violation of these restrictions, immediately remove the gate operator from service and contact your installing dealer.

**Opening device MUST be mounted a minimum of 6 feet from the gate and NOT accessible through the gate!**



- Loops and loop detectors, photo-cells or other equivalent devices must be installed to prevent the gate from closing on vehicular traffic.
- The speed limit for vehicular traffic through the gate area is 5 MPH. Install speed bumps and signs to keep vehicular traffic from speeding through the gate area. Failure to adhere to posted speed limits can result in damage to the gate, gate operator, and to the vehicle.
- Be sure that all persons who will use the gate system are familiar with the proper use of the gate and gate operator and are familiar with the possible hazards associated with the gate system.
- Be sure that warning signs are permanently installed on both sides of the gate in an area where they are fully visible to traffic.
- It is your responsibility to periodically check all entrapment protection devices. If any of these devices are observed to function improperly, remove the operator from service immediately and contact your installing or servicing dealer.
- Follow the recommended maintenance schedule.
- Do not allow children to play in the area of the operator or to play with any gate-operating device.
- To remove the gate operator from service, operate the gate to the full open position and then shut off power to the operator at the service panel.

# UL 325 Entrapment Protection

## UL 325 Classifications

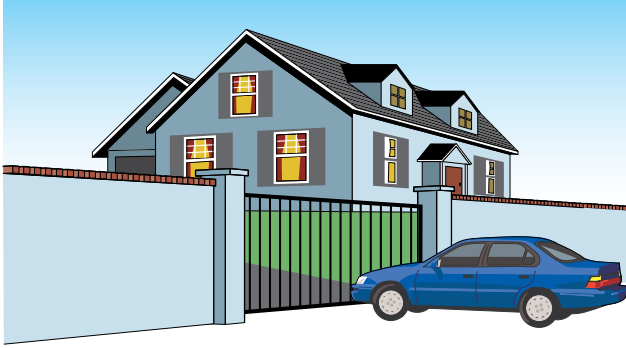

### Class I - Residential Vehicular Gate Operator

A vehicular gate operator (or system) intended for use in garages or parking areas associated with a residence of one-to four single families.



### Class III - Industrial/Limited Access Vehicular Gate Operator

A vehicular gate operator (or system) intended for use in an industrial location or building such as a factory or loading dock area or other locations not accessible by or intended to service the general public.

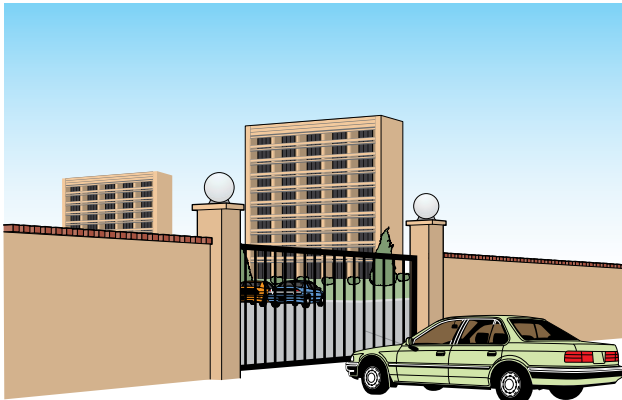

### Class II - Commercial/General Access Vehicular Gate Operator

A vehicular gate operator (or system) intended for use in a commercial location or building such as a multi-family housing unit (five or more single family units), hotel, garages, retail store, or other buildings accessible by or servicing the general public.

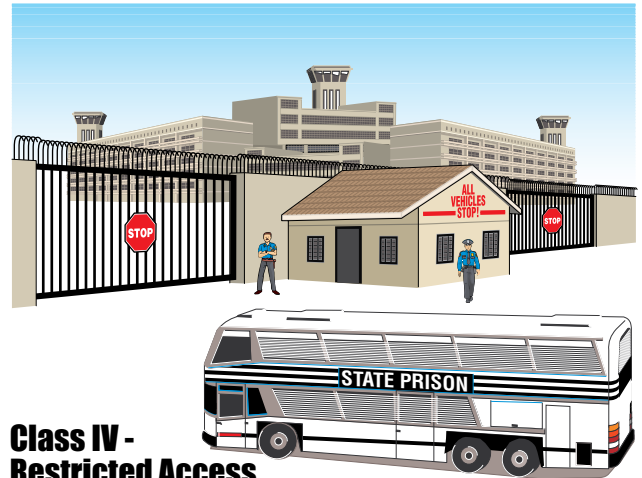

### Class IV - Restricted Access Vehicular Gate Operator

A vehicular gate operator (or system) intended for use in a guarded industrial location or building such as an airport security area or other restricted access locations not servicing the general public, in which unauthorized access is prevented via supervision by security personnel.

## Gate Operator Category

Effective January 12, 2016	Horizontal Slide, Vertical Lift, Vertical Pivot	Swing, Vertical Barrier (Arm)
<b>Entrapment Protection Types</b>	A, B1*, B2* or D	A, B1*, B2*, C or D

**Type A** - Inherent entrapment protection system.

**Type B1** - Non-contact sensor (photoelectric sensor or the equivalent).

**Type B2** - Contact sensor (edge device or equivalent).

**Type C** - Inherent force limiting, inherent adjustable clutch or inherent pressure relief device.

**Type D** - Actuating device requiring constant pressure to maintain opening or closing motion of the gate.

\* B1 and B2 means of entrapment protection must be MONITORED.

**Vertical Barrier Note:** Barrier gate operators (arm) that is not intended to move toward a rigid object closer than 16 inches (406 mm) are not required to be provided with a means of entrapment protection.

# Glossary

**GATE** - A moving barrier such as a swinging, sliding, raising, lowering, or the like, barrier, that is a stand-alone passage barrier or is that portion of a wall or fence system that controls entrance and/or egress by persons or vehicles and completes the perimeter of a defined area.

**RESIDENTIAL VEHICULAR GATE OPERATOR – CLASS I** - A vehicular gate operator (or system) intended for use in a home of one-to four single family dwelling, or garage or parking area associated therewith.

**COMMERCIAL / GENERAL ACCESS VEHICULAR GATE OPERATOR - CLASS II** - A vehicular gate operator (or system) intended for use in a commercial location or building such as a multi-family housing unit (five or more single family units), hotels, garages, retail store, or other building servicing the general public.

**INDUSTRIAL / LIMITED ACCESS VEHICULAR GATE OPERATOR - CLASS III** - A vehicular gate operator (or system) intended for use in an industrial location or building such as a factory or loading dock area or other locations not intended to service the general public.

**RESTRICTED ACCESS VEHICULAR GATE OPERATOR - CLASS IV** - A vehicular gate operator (or system) intended for use in a guarded industrial location or building such as an airport security area or other restricted access locations not servicing the general public, in which unauthorized access is prevented via supervision by security personnel.

**VEHICULAR BARRIER (ARM) OPERATOR (OR SYSTEM)** - An operator (or system) that controls a cantilever type device (or system), consisting of a mechanical arm or barrier that moves in a vertical arc, intended for vehicular traffic flow at entrances or exits to areas such as parking garages, lots or toll areas.

**VEHICULAR HORIZONTAL SLIDE-GATE OPERATOR (OR SYSTEM)** - A vehicular gate operator (or system) that controls a gate which slides in a horizontal direction that is intended for use for vehicular entrance and exit to a drive, parking lot, or the like.

**VEHICULAR SWING-GATE OPERATOR (OR SYSTEM)** - A vehicular gate operator (or system) that controls a gate which moves in an arc in a horizontal plane that is intended for use for vehicular entrance and exit to a drive, parking lot, or the like.

**SYSTEM** - In the context of these requirements, a system refers to a group of interacting devices intended to perform a common function.

**WIRED CONTROL** - A control implemented in a form of fixed physical interconnections between the control, the associated devices, and an operator to perform predetermined functions in response to input signals.

**WIRELESS CONTROL** - A control implemented in means other than fixed physical interconnections (such as radio waves or infrared beams) between the control, the associated devices, and an operator to perform predetermined functions in response to input signals.

**INHERENT ENTRAPMENT PROTECTION SYSTEM** - A system, examples being a motor current or speed sensing system, which provides protection against entrapment upon sensing an object and is incorporated as a permanent and integral part of the operator.

**EXTERNAL ENTRAPMENT PROTECTION DEVICE** - A device, examples being an edge sensor, a photoelectric sensor, or similar entrapment protection device, which provides protection against entrapment when activated and is not incorporated as a permanent part of an operator.

**ENTRAPMENT** - The condition when an object is caught or held in a position that increases the risk of injury.



# Swing Gate Requirements

**The operator is intended for installation only on gates used for vehicles.** Pedestrians must be supplied with a separate access opening. The pedestrian access opening shall be designed to promote pedestrian usage. Locate the gate such that persons will not come in contact with the vehicular gate during the entire path of travel of the vehicular gate.

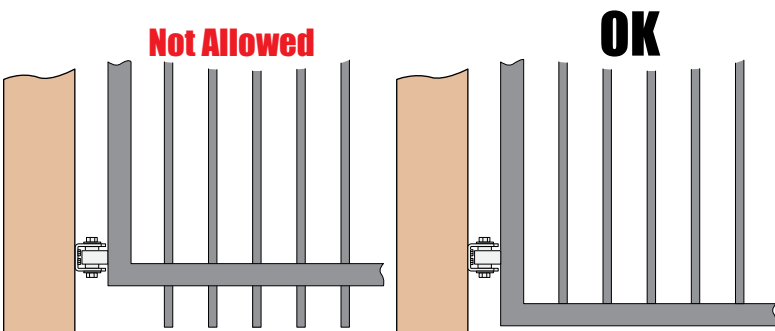
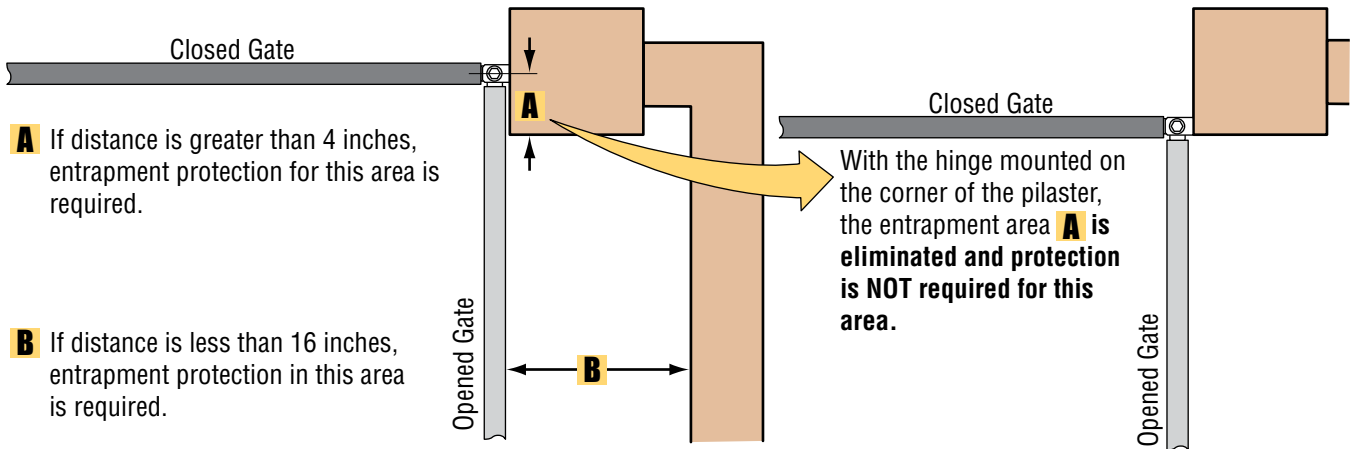
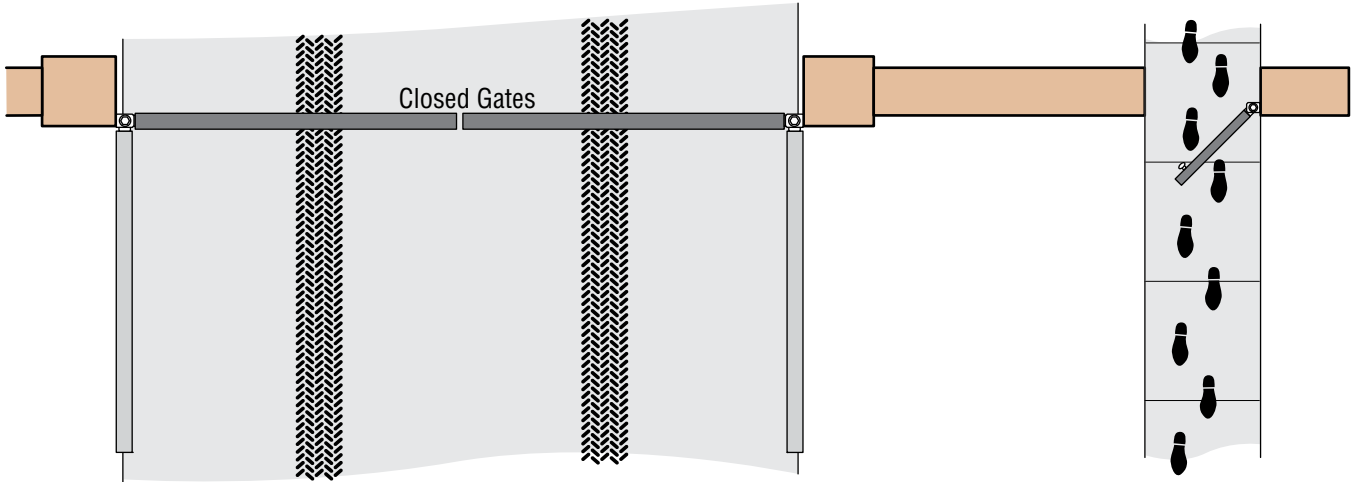

Gates shall have smooth bottom edges, with vertical bottom edged protrusions not exceeding 0.50 inches.

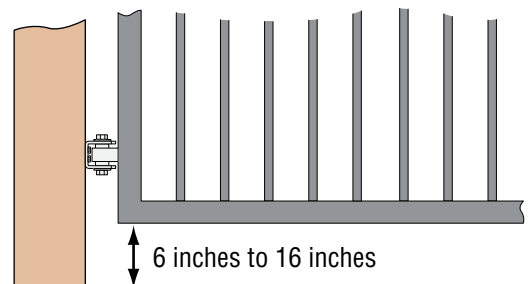

If bottom of gate is 6" to 16" above the ground at any part of the gate's traveling path, entrapment protection for this area is required.

# Swing Gate Protection

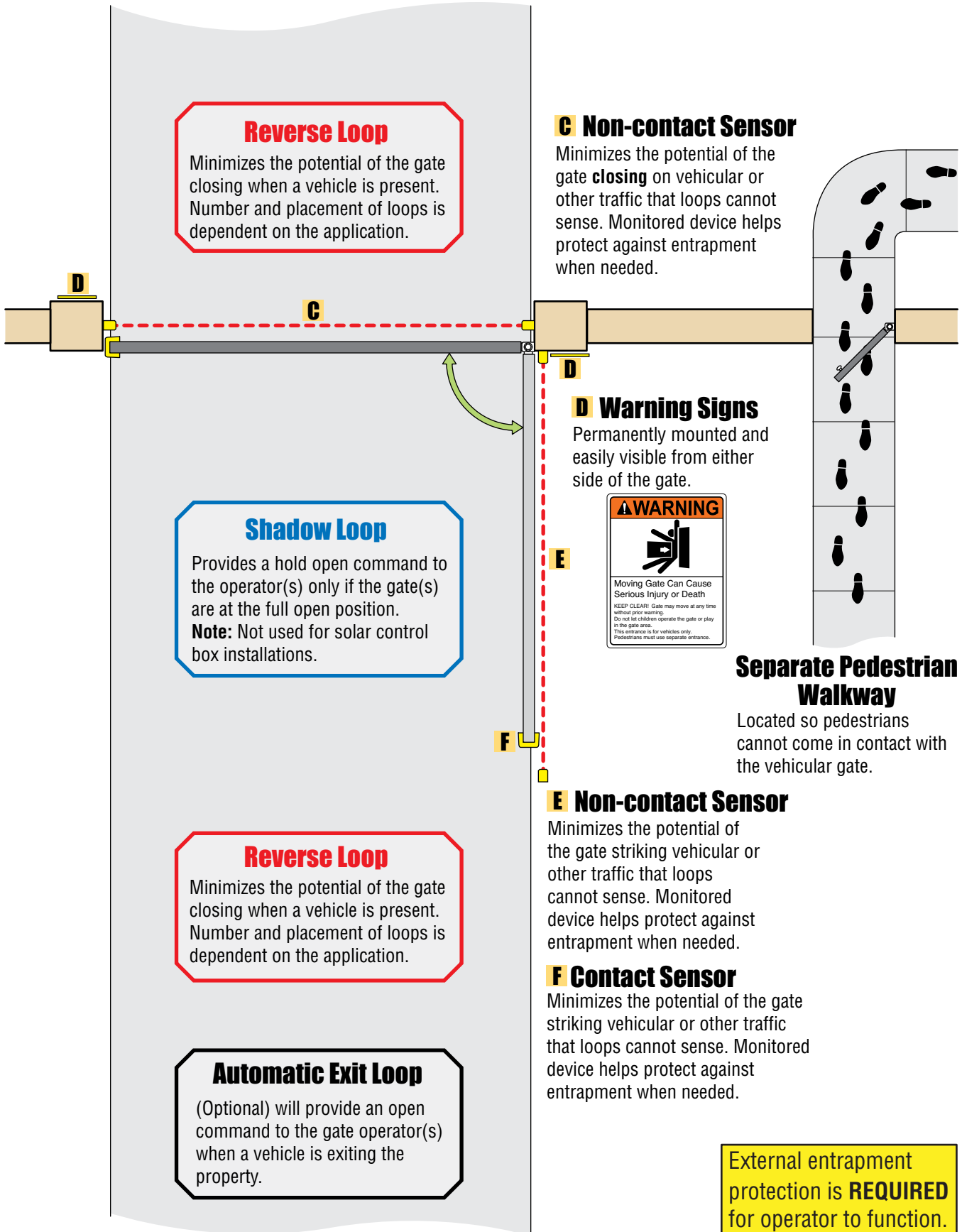

# SECTION 1 - SOLAR PANEL INSTALLATION CONSIDERATIONS

## 1.1 Concerns BEFORE Installation

Correct positioning of the solar panel will determine the efficiency of the system. In general, the panel should be facing **TRUE SOUTH** at a specific **TILT ANGLE** towards the sun using the information provided on the next page to achieve the highest efficiency. Some re-adjustment of the panel might be necessary to over time to “Fine Tune” the systems efficiency. The solar panel should be installed as close as possible to the control box in an area free and clear of **ALL** obstructions and shadows during the **ENTIRE** day. Generally, if the solar panel does **NOT** cast a shadow by the sun, the batteries are **NOT** being charged.

- **Trees / Buildings** that do not block the solar panel from direct sunlight in the summer, **could** block the panel during the winter. The sun’s path across the sky is lower during the winter than in the summer. The shadows that do not obstruct the solar panel during the summer months, will cast longer shadows in the winter, which could block the panel then.
- **Wind** can exert extreme pressure on the solar panel and support post. Make sure they are securely fastened.
- **Dust** can accumulate on the panel over time. Cleaning the panel every so often is necessary to keep the system operating at its highest efficiency.
- **Snow** may cover the panel during the winter. You may want to re-adjust the panel to a steeper angle to allow the snow to slide off. Even then, the panel may still accumulate snow and need to be manually cleaned off when necessary to keep the system functioning.

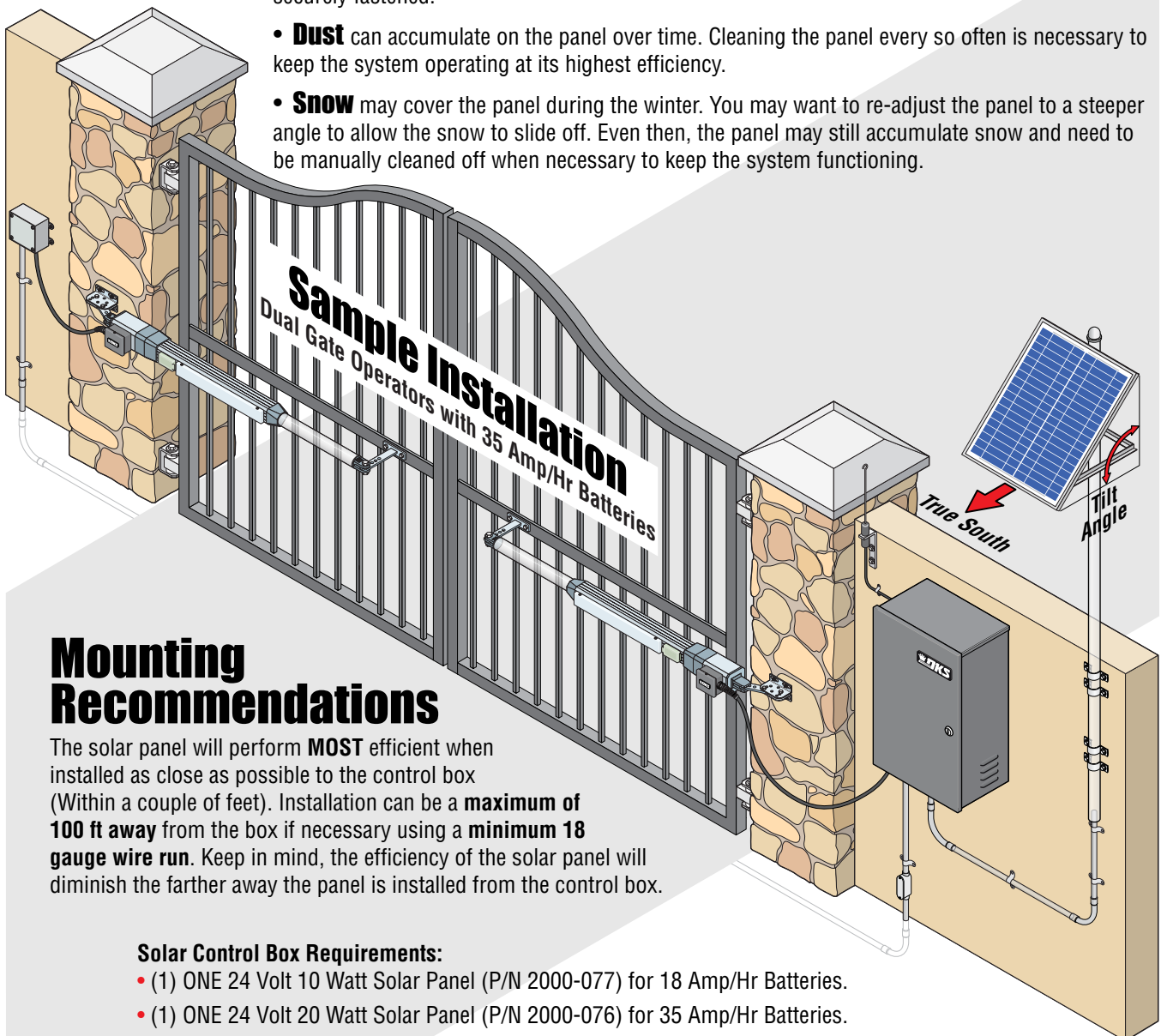

## Mounting Recommendations

The solar panel will perform **MOST** efficient when installed as close as possible to the control box (Within a couple of feet). Installation can be a **maximum of 100 ft away** from the box if necessary using a **minimum 18 gauge wire run**. Keep in mind, the efficiency of the solar panel will diminish the farther away the panel is installed from the control box.

### Solar Control Box Requirements:

- (1) ONE 24 Volt 10 Watt Solar Panel (P/N 2000-077) for 18 Amp/Hr Batteries.
- (1) ONE 24 Volt 20 Watt Solar Panel (P/N 2000-076) for 35 Amp/Hr Batteries.

# 1.2 Solar Panel Positioning

These charts should be used only for estimates. Solar systems can vary from this information. These maps do not take into account small climate changes and may not be 100% accurate for all locations.

## Solar Panel MUST Point "TRUE SOUTH"

It is important for proper system operation that the solar panel is oriented to **TRUE SOUTH**. The directions of magnetic South and TRUE South differ from one another depending on geographic location. The map below shows the difference between magnetic south and TRUE south for your area.

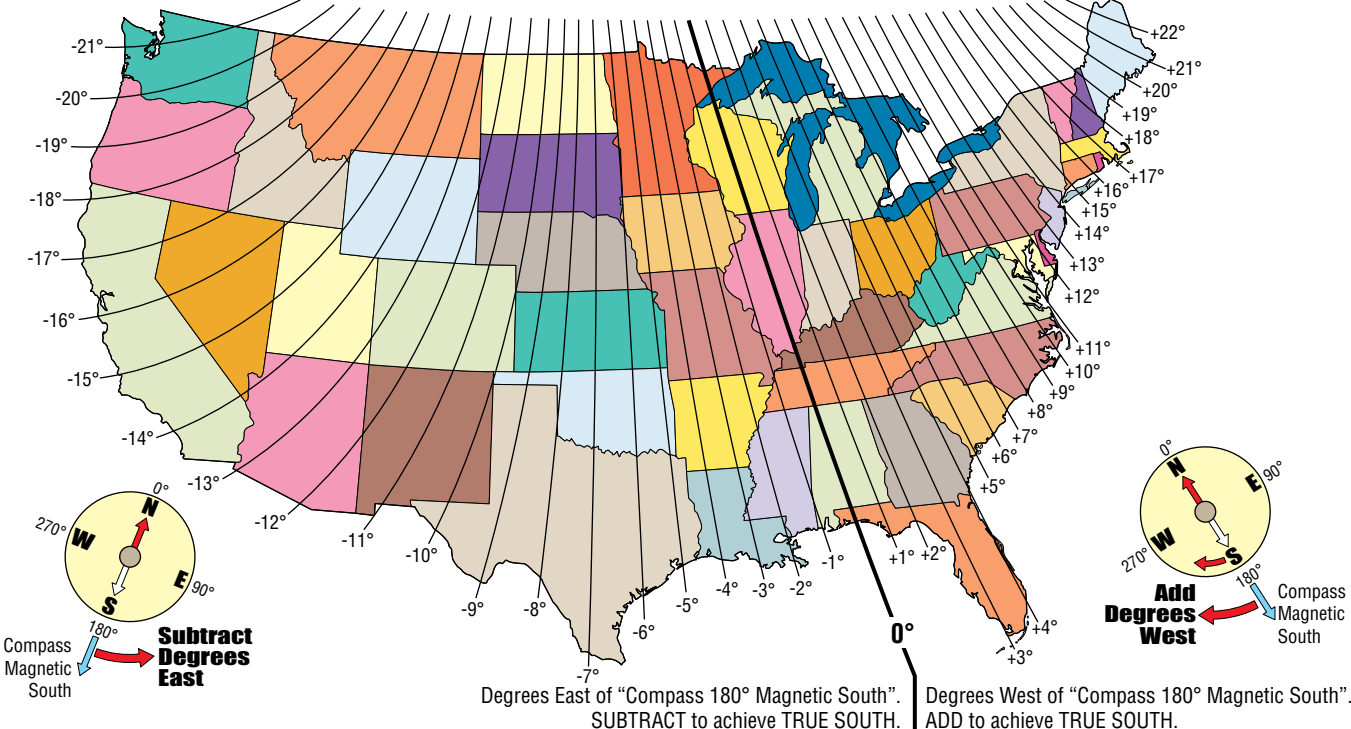

## General Solar Panel "Tilt Angle"

It is simplest to mount the solar panel at a fixed tilt angle and leave it (Shown on chart below). To capture more energy from the sun, you can adjust the tilt angle of the solar panel twice a year (At the beginning of summer and winter). Add approximately 6° in the summer and subtract approximately 6° in the winter from your "general" tilt angle on this chart. Your tilt angle may vary from this.

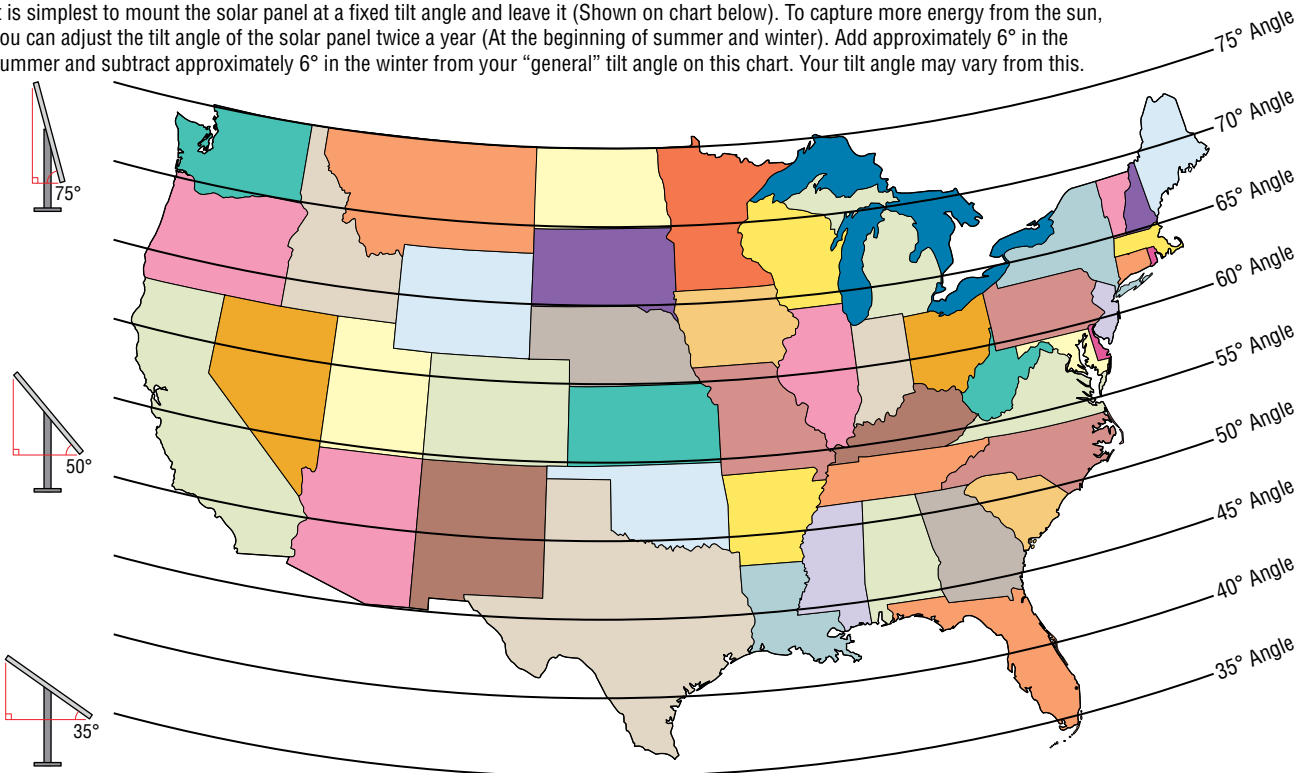

# SECTION 2 - WIRING

Since building codes vary from city to city, we highly recommend that you check with your local building department prior to installing any permanent wiring to be sure that all wiring to the solar control box complies with local code requirements.

## 2.1 Control Box Wiring Overview

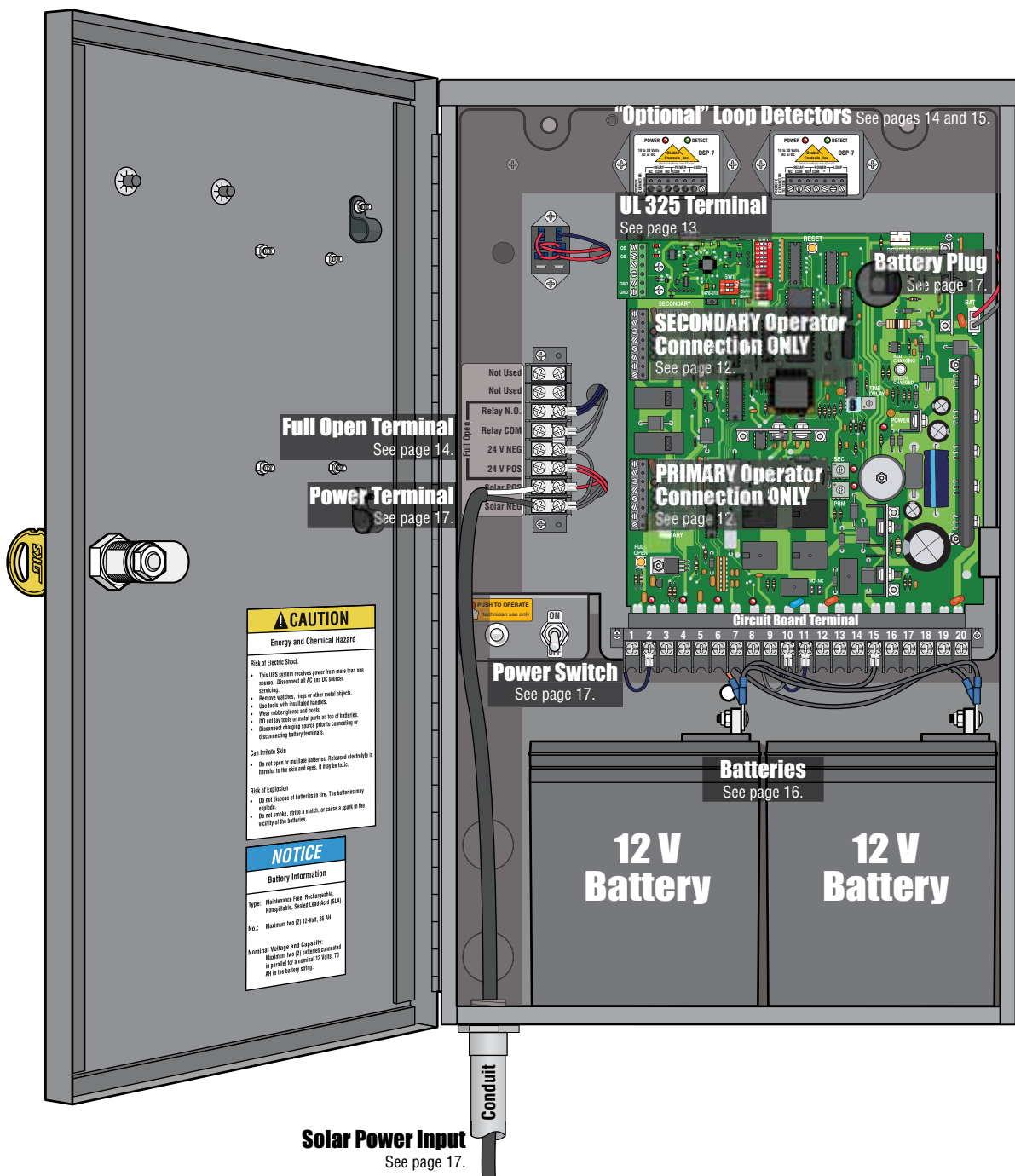

# 2.2 Wiring Operators to 4302 Circuit Board

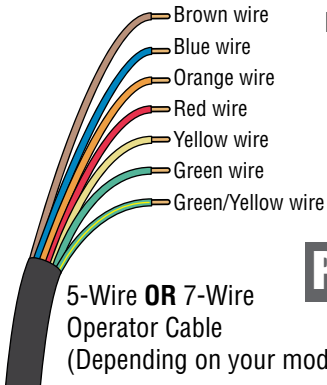

**IMPORTANT:** An external entrapment protection device **MUST** be installed or the operator will **NOT** function.

**Secondary Operator ONLY**

**DO NOT** connect primary/single operator to this terminal.

**Primary/Single Operator ONLY**

**DO NOT** connect secondary operator to this terminal.

**DO NOT** cycle the operator **BEFORE** setting limit sensors.

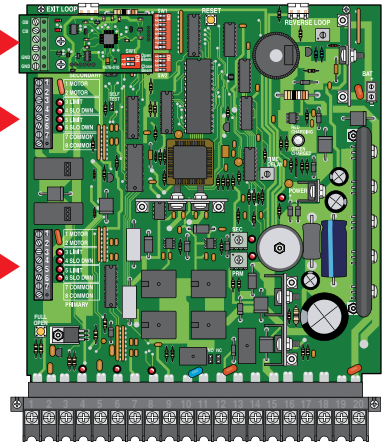

**Choose Your Operator Model:** Follow wiring colors for the PRIMARY/Single or DUAL gate operators.

### 6003 Wiring

### 6004 Wiring

7-Wire Operator Cable

Factory wired jumpers **MUST** be removed.

#### Primary/Single operator wiring

1	1 MOTOR
2	2 MOTOR
3	3 LIMIT
4	4 SLO DWN
5	5 LIMIT
6	6 SLO DWN
7	7 COMMON
8	8 COMMON

PRIMARY

#### Secondary operator wiring

1	1 MOTOR
2	2 MOTOR
3	3 LIMIT
4	4 SLO DWN
5	5 LIMIT
6	6 SLO DWN
7	7 COMMON
8	8 COMMON

SECONDARY

### 6005 Wiring

5-Wire Operator Cable

**Note:** RED and GREEN wires from operator cable are not used.

Factory wired jumpers **MUST** remain connected as shown. SLO DWN LEDs are always lit.

#### 6005 Primary/Single operator wiring

1	1 MOTOR
2	2 MOTOR
3	3 LIMIT
4	4 SLO DWN
5	5 LIMIT
6	6 SLO DWN
7	7 COMMON
8	8 COMMON

PRIMARY

#### 6005 Secondary operator wiring

1	1 MOTOR
2	2 MOTOR
3	3 LIMIT
4	4 SLO DWN
5	5 LIMIT
6	6 SLO DWN
7	7 COMMON
8	8 COMMON

SECONDARY

### 6400 Wiring

7-Wire Operator Cable

**Note:** Secondary operator MOTOR wires **MUST** be reversed from the primary operator when using DUAL gate operators.

Factory wired jumpers **MUST** be removed.

#### 6400 Primary/Single operator wiring

1	1 MOTOR
2	2 MOTOR
3	3 LIMIT
4	4 SLO DWN
5	5 LIMIT
6	6 SLO DWN
7	7 COMMON
8	8 COMMON

PRIMARY

#### 6400 Secondary operator wiring

1	1 MOTOR
2	2 MOTOR
3	3 LIMIT
4	4 SLO DWN
5	5 LIMIT
6	6 SLO DWN
7	7 COMMON
8	8 COMMON

SECONDARY

## 2.3 Entrapment Protection Wiring

### External Entrapment Protection Devices:

In addition to the inherent reversing sensor system, this operator has a UL 325 terminal for the connection of **photo sensors-Type B1 and/or reversing edges-Type B2** entrapment protection required by UL 325 standards. **Entrapment Protection must be provided for the gate system where the risk of entrapment or obstruction exists. The operator will NOT run without one or more monitored type B1 or B2 external entrapment protection devices installed in each entrapment area.** Install these devices where the risk of entrapment or a safety hazard exists. Installations can vary.

#### OPEN/CLOSE Edge/Beam UL 325 DIP-Switch 1 ON:

**OPENING:** Obstructed open-direction device will **Reverse** the gate to the CLOSE position.

#### CLOSE Beam UL 325 DIP-Switch 2 ON:

**CLOSING:** Obstructed closing-direction photo beam will **REVERSE** the gate to the open position and reset timer when ON.

**CLOSING:** Obstructed close-direction Beam will Reverse the gate back to the open position and reset timer. If obstruction occurs again during the closing-direction, Gate will reverse back to open position and enter a soft shutdown.

#### Type of wiring to be used on ALL external devices:

- A) Type CL2, CL2P, CL2R, or CL2X.
- B) Other cable with equivalent or better electrical, mechanical, and flammability ratings.

#### OPEN/CLOSE Edge/Beam:

Input will activate in **EITHER** direction of gate travel.

#### CLOSE Beam:

Input will activate in **CLOSE** direction of gate travel **ONLY**.

## UL 325 Terminal

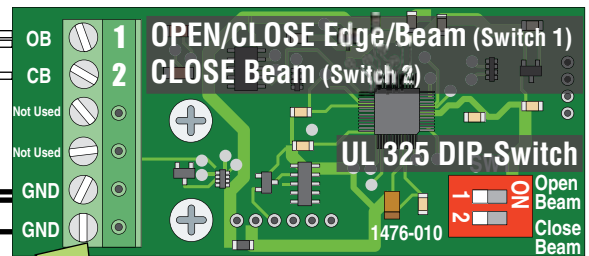

Only 1 Device can be wired to each input.

DIP-switches **MUST** be turned **ON** for each device wired to terminal.

**Note:** Only 1 monitored Device can be connected to each input. An **OPTIONAL** Expansion Kit (sold separately) will allow connection for additional devices.

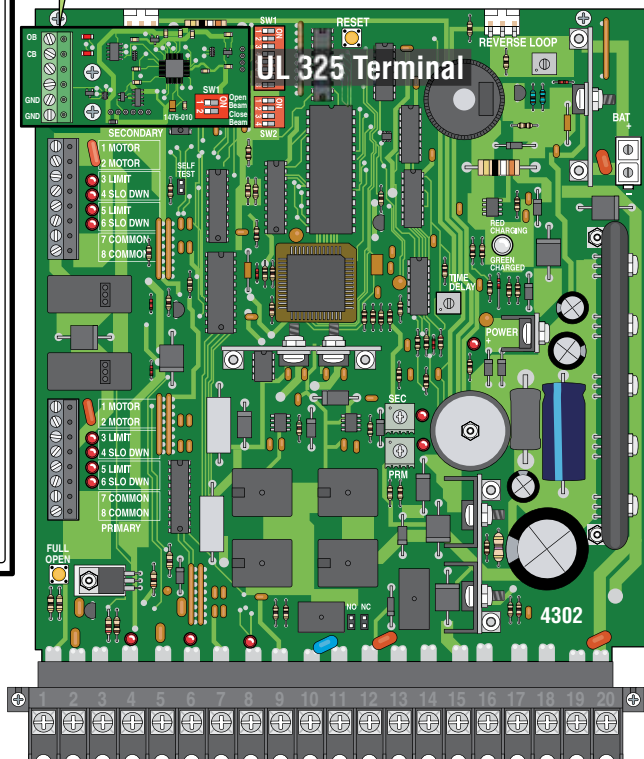

**IMPORTANT:** Photo sensors must use **Normally Closed (NC)** contacts with the beam set for light operate (relay activated when beam is not obstructed). Some manufacturer's photo sensor contacts are labeled as **Normally Open (NO)** but their relay functions the same way as described above. See specific manufacturer's wiring manual for more information about their specific relay function.

### Monitored OPEN Photo Sensor OR Monitored OPEN/CLOSE Reversing Edge

Reversing Edge  
 OPEN Beam  
 Close Beam  
 Switch 1 Must be ON for reversing edge.

If the distance between an entrapment or obstruction exists less than 16" from the open gate, then entrapment protection is **REQUIRED** for this area.

Closed Gate  
 CLOSE Beam  
 Switch 2 Must be ON.

Entrapment protection is **RECOMMENDED** for this area.

### Monitored CLOSE Photo Sensor

# 2.4 Full Open Terminal Wiring

## Key Switch (Dry contact)

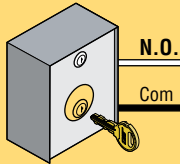

Controls must be far enough from the gate so that the user is prevented from coming in contact with the gate while operating them. **Do not** wire any access control devices to the circuit board terminal.

## DoorKing RF Radio Receiver

Mount inside of control box door.

Antenna mounted outside control box.

Coax Antenna Kit P/N 1514-073

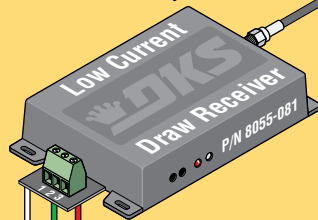
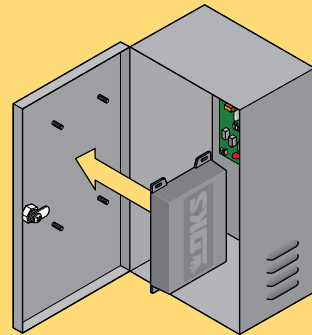

Radio #1 Com (White)  
Radio #2 Relay (Green)  
Radio #3 Power (Red)

**Type of wiring to be used on ALL external devices:**  
A) Type CL2, CL2P, CL2R, or CL2X.  
B) Other cable with equivalent or better electrical, mechanical, and flammability ratings.

## Safety Opening Device

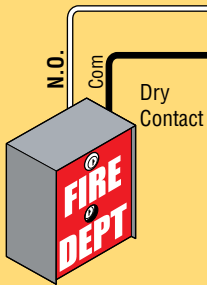

## Low Current Draw Single Channel External EXIT Loop Detector

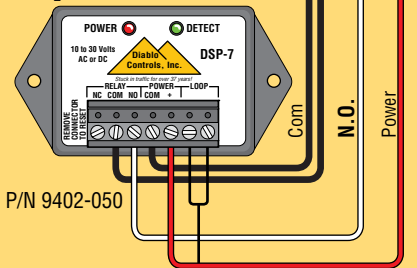

P/N 9402-050

See next page for more exit loop wiring information.

## Low Current Draw Single Channel External REVERSE Loop Detector

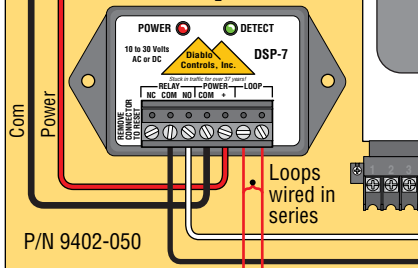

P/N 9402-050

**Important:** Low current draw loop detectors **MUST** be used to minimize power drain on batteries. Loop detectors **MUST** have power at **ALL** times.

**Full Open Terminal Operation:** When the circuit board is **NOT** in use (idle time), power is shut down to it. Power will continue at the **Full Open Terminal at all times**. This allows an access control device - radio receiver, key switch, exit loop or safety opening device to be activated at any time to open the gate. **ANY access control device used needs a relay contact time of AT LEAST 1 SECOND** to bring the circuit board out of "idle time" and operate gate.

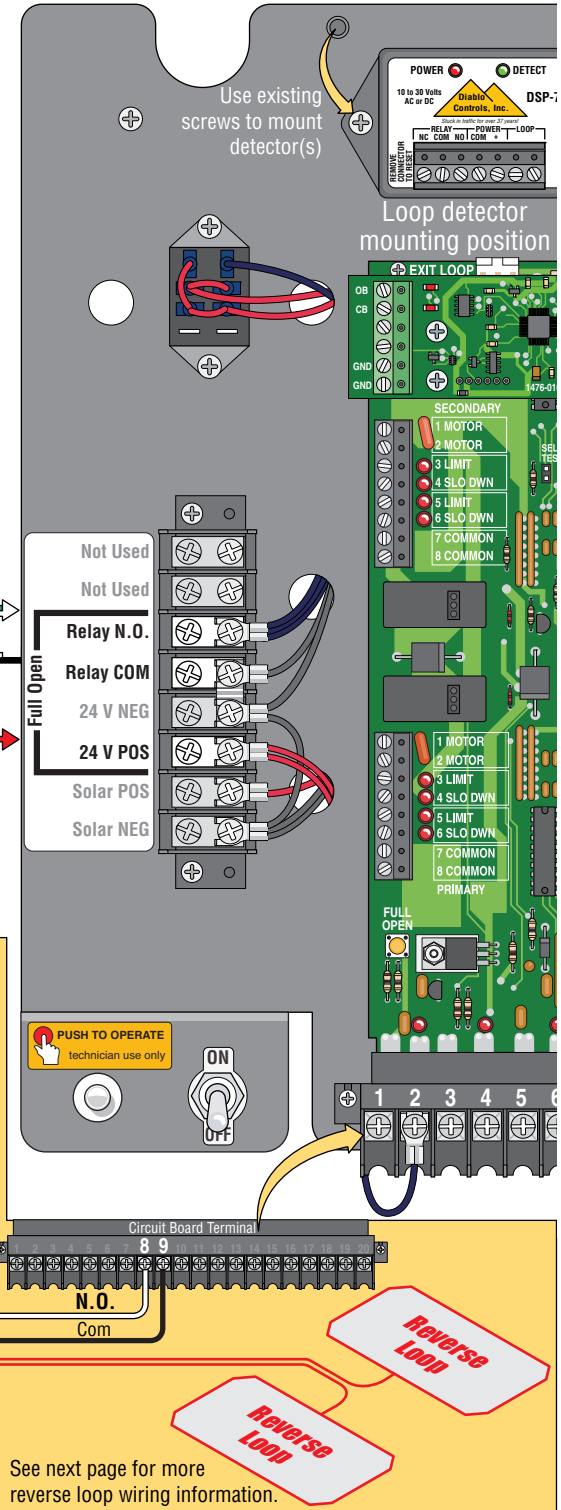

See next page for more reverse loop wiring information.



# 2.5 Loop Detector Wiring

To help protect the operator from accidentally closing on vehicles in the gate's path, DoorKing highly recommends that loops and loop detectors are used. A loop detection system will sense a vehicle like a metal detector and send a signal to the gate operator preventing the gate from automatically opening or closing on a vehicle when it is in the gate's path. DoorKing recommends that a licensed installer perform this work.

**Type of wiring to be used on ALL external devices:**  
**A)** Type CL2, CL2P, CL2R, or CL2X.  
**B)** Other cable with equivalent or better electrical, mechanical, and flammability ratings.

DoorKing offers a free "Loop and Loop-Detectors Information Manual" PDF located at DoorKing's web site for more information. [www.doorking.com](http://www.doorking.com)

**Shadow Loop Note:** A shadow loop can **NOT** be wired to the solar control box.

## Reverse Loops

Reverse loops prevent the gate from closing on a vehicle in or near the gate's swing pathway.

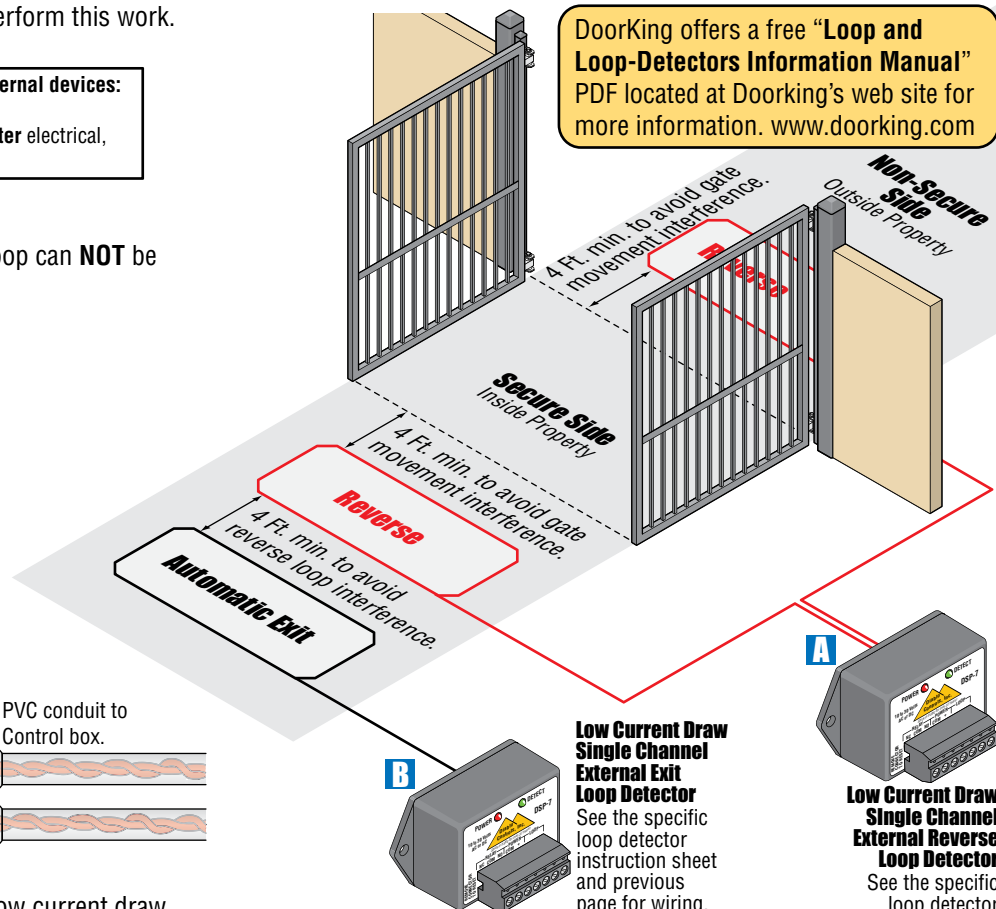
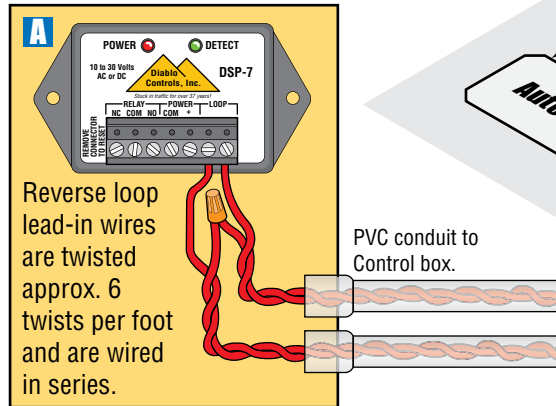

**Low Current Draw Single Channel External Exit Loop Detector**  
 See the specific loop detector instruction sheet and previous page for wiring.

**Low Current Draw Single Channel External Reverse Loop Detector**  
 See the specific loop detector instruction sheet and previous page for wiring.

**Exit and Reverse Loops Note:** Low current draw external exit and reverse loop detectors are used in place of the plug-in exit and reverse loop detectors to maintain power to these loops at all times. Circuit board shuts down power to plug-in loop detectors when not in use (idle time).

**ANY loop detector used needs a relay contact time of AT LEAST 1 SECOND to bring circuit board out of "idle time" and operate gate.**

## Automatic Exit Loop

Automatically opens the gate for exiting vehicles without having to use a transmitter or key switch (Free exit).

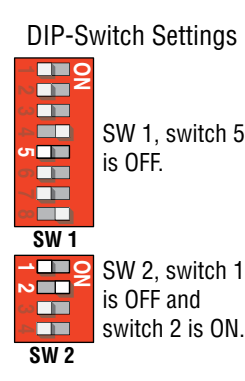
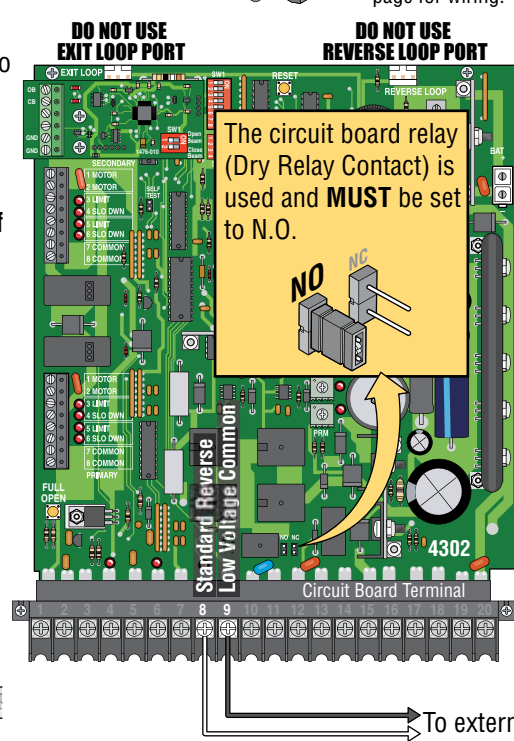
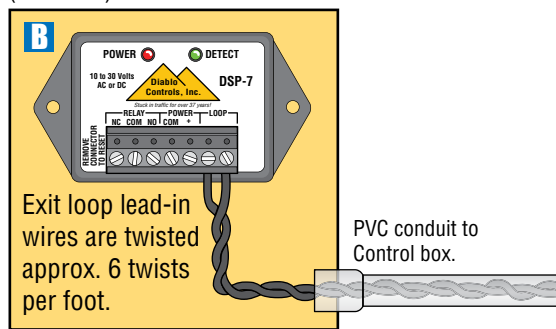

## 2.6 Battery Wiring

**Temperatures** will affect the efficiency of the batteries. The batteries “optimal” operating temperature is approximately 77°F (25°C). They will not charge as quickly or cycle the gate operator as many times at lower temperatures. The lower the temperature is, the longer it will take for the batteries to fully charge and the fewer times the gate operator can be cycled before the batteries are drained. When batteries are continually operating at higher temperatures, they will wear out quicker. The higher the temperature is, the shorter the battery life.

**Clouds** will affect the efficiency of the batteries charging. The batteries “optimal” charging capacity is full sunlight. Charging time will vary depending on the density of the cloud cover and the amount of time that the cloud cover lasts. It will take the batteries longer to fully charge on cloudy days. Multiple cloudy days may not allow the batteries to get fully charged again after they have been drained resulting in the system not being able to cycle the gate until the sun returns.

### DoorKing Recommends:

(2) **Two 12 Volt 18 Amp/Hr batteries:** Use for applications with normal usage (60 cycles per day or less).

(2) **Two 12 Volt 35 Amp/Hr batteries:** Use for applications with higher usage (60 cycles per day or more).

12 Volt batteries smaller than 18 Amp/Hr are **NOT** recommended.

**DO NOT cycle the gate operator at this time.** Damage could occur to the gate and operator.

**Battery Replacement Note:** DoorKing **HIGHLY** recommends replacing the batteries every two years because of normal battery deterioration.

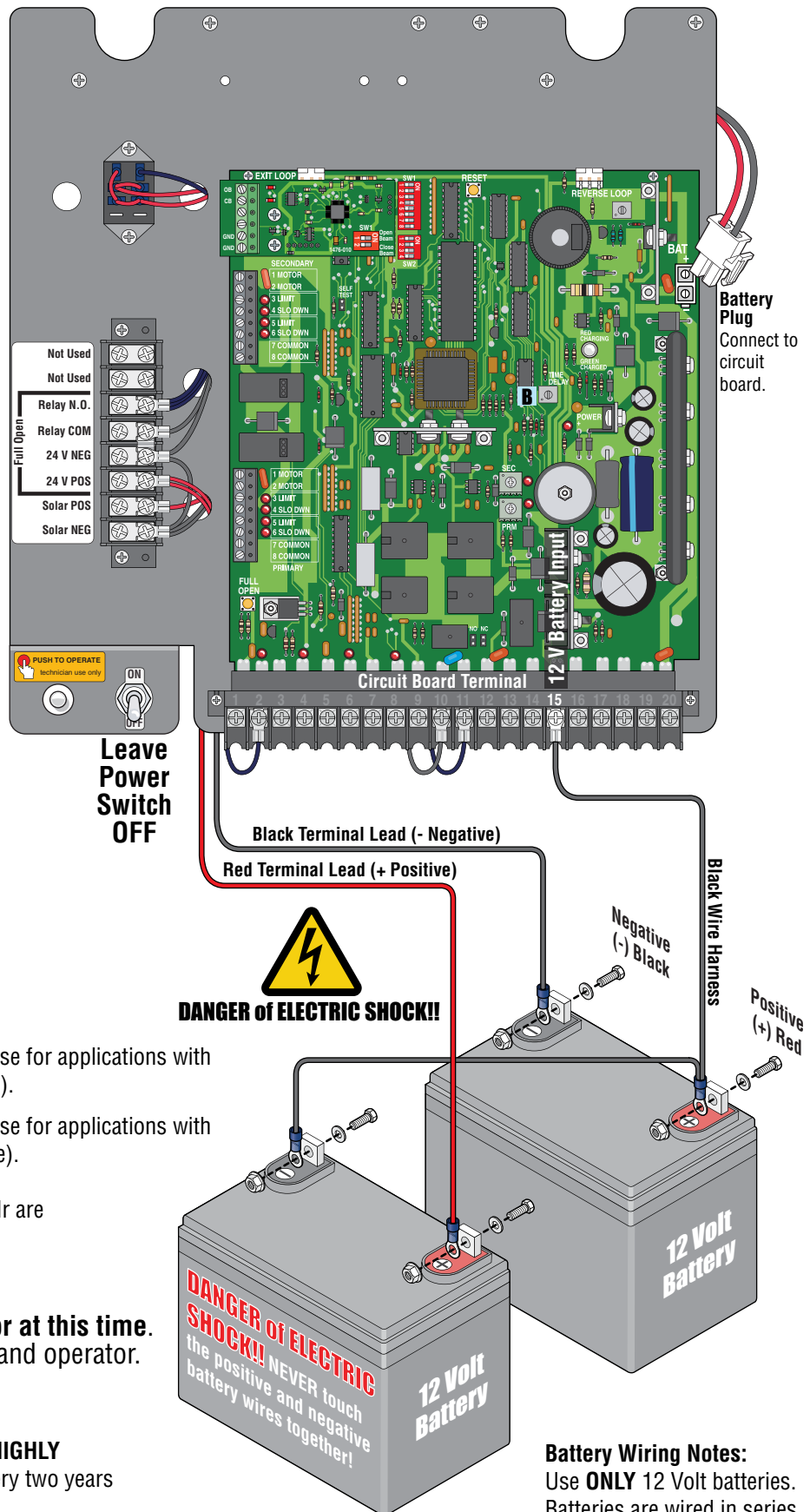

## 2.7 Solar Panel Wiring

An **EXTERNAL ENTRAPMENT PROTECTION DEVICE** **MUST** be connected or the gate operator **WILL NOT** function.

**How the system's 24 volt power is managed:** When the system is **NOT** in use (idle time), the power management relay will shut down power to the circuit board. Power will continue at the **Full Open - Power Terminal**, keeping the overall power drain of the system to a minimum during idle time. When an access control device - transmitter, key switch, exit loop or safety opening device is activated while the system is idle, the power management relay powers up the circuit board to open the gate.

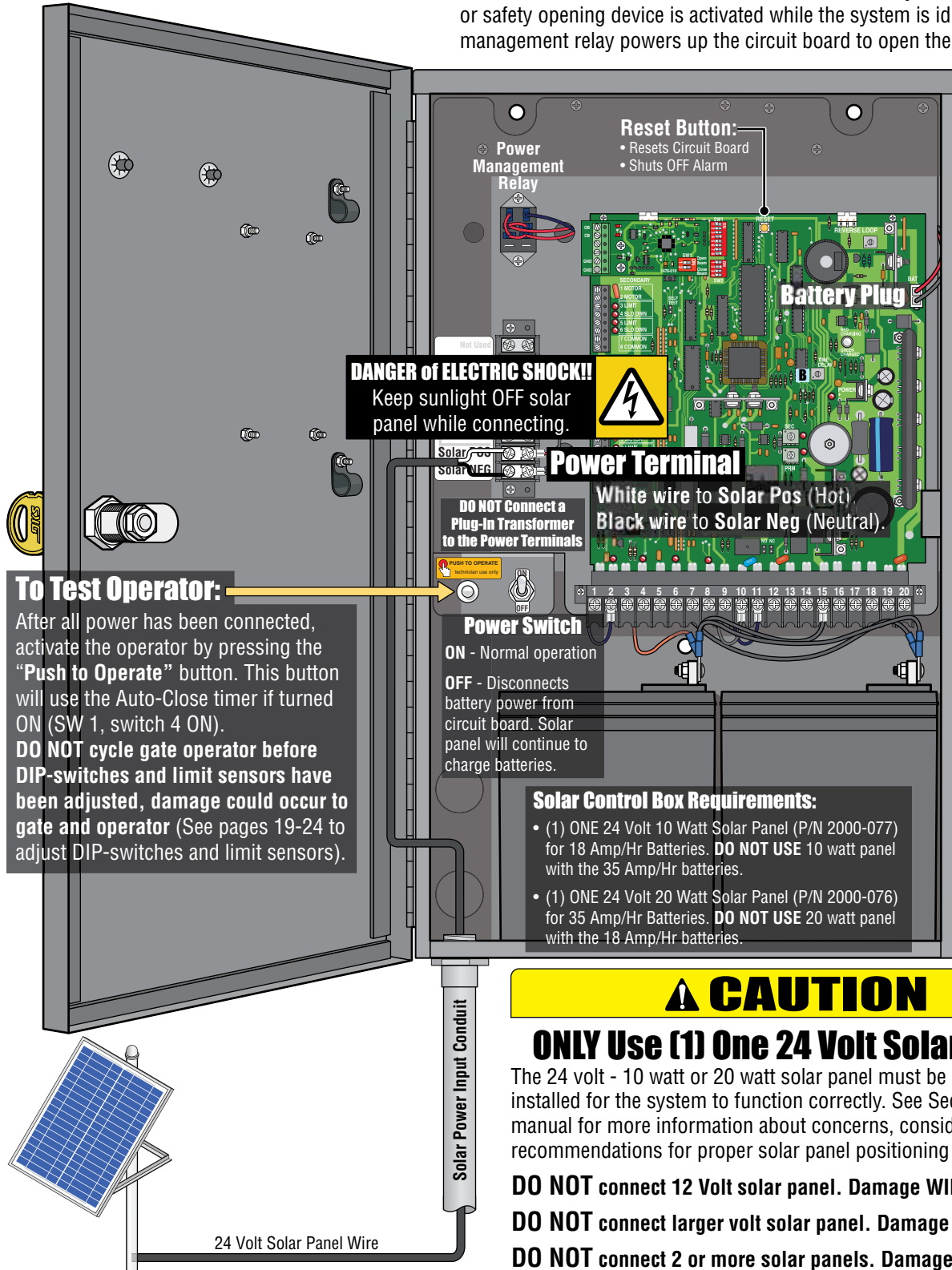

# SECTION 3 - ADJUSTMENTS

The switch settings and adjustments in this section should be made after your installation and wiring to the operator(s) is complete. **Whenever any programming or switch setting on the control board are changed, press the reset button for new settings to take effect.**

## 3.1 4302 Circuit Board Description and Adjustments

### DIP-Switches

Set DIP-switches on the circuit board to the desired setting. See switch-setting charts on next 2 pages.

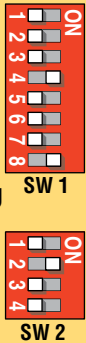

### How LEDs Function



Illuminated LEDs Indicates that low voltage power is being applied to the circuit board.

**Input LEDs** should be OFF and will only illuminate when the input wired to the corresponding main terminal is activated.

**Limit LEDs** will only illuminate when the respective limit sensor has been activated.

### Self Test



**Self Test Mode**

Self test mode is for bench checks **ONLY**. The operator will continually cycle the gate.



**Normal Mode**

The jumper must be set at normal mode to function.

### FULL OPEN



Cycles the operator when pressed. Will use Auto-Close timer when turned ON. This switch **WILL NOT** function when there is **NO** power to the circuit board (Idle time).

### "Optional" Loop Detectors

See pages 14 and 15.

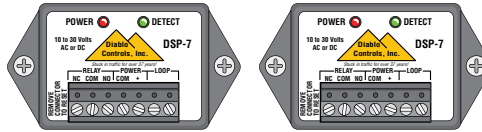

**UL 325 Terminal**  
See page 13.

**DO NOT USE EXIT Loop Port**

**DO NOT USE Reverse Loop Port**

### RESET



Press reset button to activate changed control board settings. Turns OFF activated alarm (See page 27).

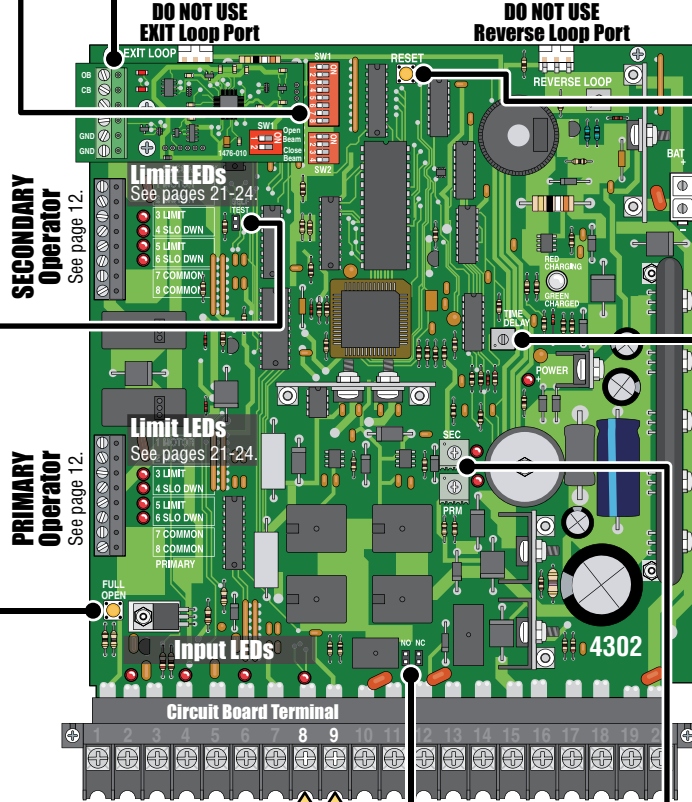

**Battery Plug**  
See page 16.

### Auto-Close Timer

Auto-close timer (when turned ON) SW 1, switch 4.

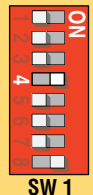

Adjust from 1 second (full counter-clockwise) to approximately 23 seconds (full clockwise).



### Inherent Reverse Sensors

Adjust reversing sensitivity for: PRIMARY (single) and SECONDARY (dual) operators. See page 25.

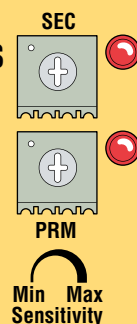

### Dry Relay Contact

Dry relay contacts - Circuit board terminals #10 and #11. Jumper **MUST** be set for Normally Open (NO). **DO NOT** use Normally Closed (NC).

- Standard reverse loop function, See page 15.

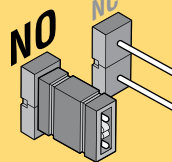

Used to wire external reverse loop detector. See page 15.

## 3.2 DIP-Switches

Whenever any programming or switch setting on the control board is changed, press the reset button for new settings to take effect.

### SW 1 (Top 8 Switches)

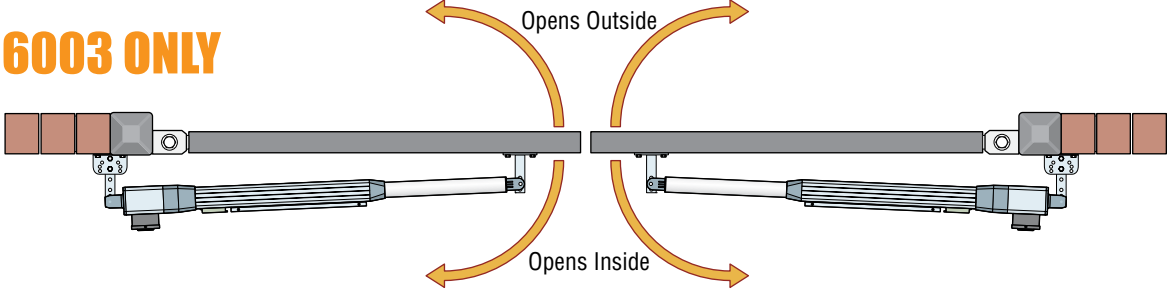
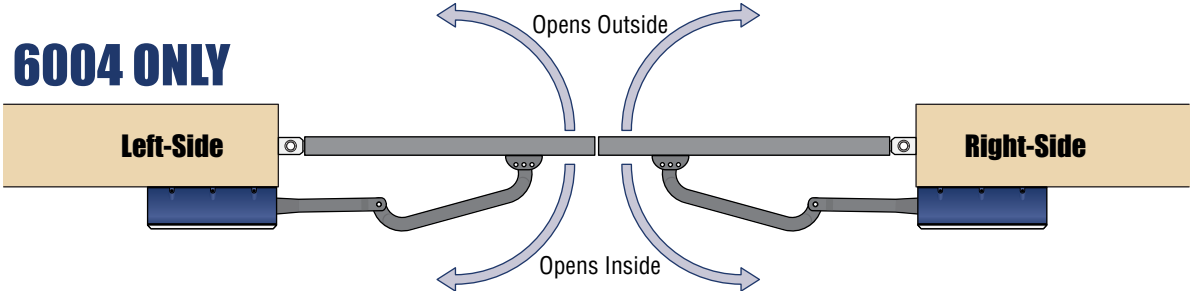
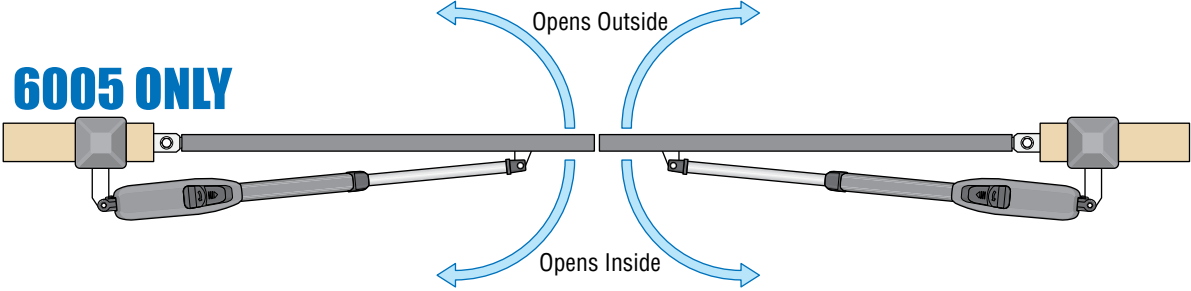
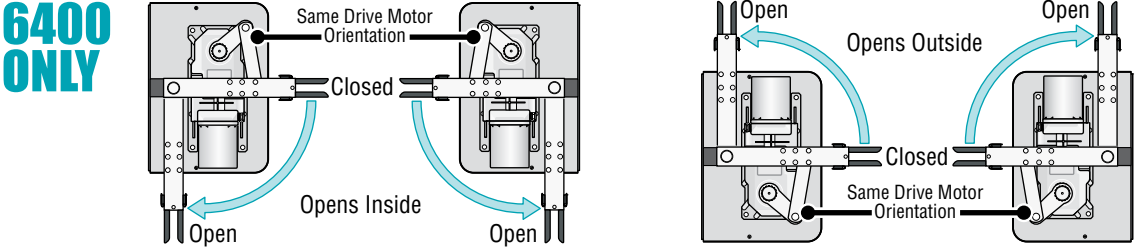
Switch	Function	Setting	Description
1			<p><b>Opening Direction of PRIMARY Operator</b></p> <p>The operator <b>MUST OPEN GATE</b> upon initial power up and <b>OPEN</b> command. If the operator closes gate after giving open command, shut off power and reverse this switch setting otherwise operator will <b>NOT</b> function correctly.</p>
			<p><b>6003 ONLY</b></p> 
			<p><b>6004 ONLY</b></p> 
			<p><b>6005 ONLY</b></p> 
			<p><b>6400 ONLY</b></p> 
2	Opening Direction of <b>SECONDARY</b> Operator		<p>Same opening directions as illustrated above for the primary operator type.</p> <ul style="list-style-type: none"> <li>Switch 2 will be the <b>SAME</b> setting as switch 1 for the 6003.</li> <li>Switch 2 will be the <b>OPPOSITE</b> setting as switch 1 for the 6004, 6005 and 6400.</li> </ul> <p>Note: SW 1, switch 7 <b>MUST</b> also be <b>ON</b> when using a secondary operator.</p>

SW 1 Switches continued on next page

## 3.2 DIP-Switches Continued

### SW 1 (Top 8 Switches) continued

Switch	Function	Setting	Description
<b>3</b>	Not Used	OFF	Leave in the OFF position.
<b>4</b>	Auto-Close Timer	OFF	Auto-close timer is OFF. Manual input required to close gate.
		ON	Auto-close timer is ON. Adjustable from 1-23 seconds.
<b>5</b>	Reverse	OFF (normal)	Terminal #8 is a standard Reverse input.
	Not Used	ON	On setting is NOT used.
<b>6</b>	Overlapping Gates	OFF	Both operators start at the same time.
		ON	Secondary operator opens 1-2 seconds before primary operator. Vice-versa when closing.
<b>7</b>	Single	OFF	Switch must be OFF for single operator.
	Dual	ON	Switch must be ON when (dual) operators are used.
<b>8</b>	Input Power	ON	Switch MUST be in the ON position.

### SW 1 Switch Definitions:

**SW 1-Switch 1:** PRIMARY motor direction switch - **Must** OPEN the primary gate upon initial AC power up and open command. If the open command begins to close the primary gate, turn AC power off and reverse this switch.

**SW 1-Switch 2:** SECONDARY motor direction switch - **Must** OPEN the secondary gate upon initial AC power up and open command. If the open command begins to close the secondary gate, turn AC power off and reverse this switch.

**SW 1-Switch 3:** Not used, leave in the OFF position.

**SW 1-Switch 4:** Turns the auto-close timer on or off. Maximum time that the close timer can be set for is approximately 23 secs.

**SW 1-Switch 5:** OFF setting is Standard Reverse for a **CLOSING** gate. An input to terminal #8 (e.g.: N.O.-photo beam gets obstructed, **NOT** entrapment protection) **AND/OR** reverse loops get activated will stop and **reverse** the gate back to the full open position. If the auto-close timer is ON, when gate reaches the open position, timer **will not** close the gate. Another input command is needed to reset and close the gate. **DO NOT** use the **ON** setting.

**SW 1-Switch 6:** When the gate overlap is **OFF**, the **DUAL** gate operators will start the open and close cycles at the **same time**. This is the normal setting for a **SINGLE** gate operator.

Turning the gate overlap **ON** when using dual gate operators will cause the secondary operator to start the **OPEN** cycle 1-2 seconds **before** the primary operator. The primary operator will start the **CLOSE** cycle 1-2 seconds **before** the secondary operator. This feature is useful when a magnetic lock is used to secure the gates.

**SW 1-Switch 7:** Sets up the circuit board for single or dual (Primary / Secondary) gate operation.

**SW 1-Switch 8:** Input power switch. Switch **MUST** be in the ON position for a solar control box. **DO NOT** turn switch OFF.

### SW 2 (Bottom 4 Switches)

Switch	Function	Setting	Description
<b>1 and 2</b>	Relay Operation	1-OFF 2-ON	Circuit board relay activates when the gate is NOT closed.
<b>3</b>	Not Used	OFF	Leave in the OFF position.
<b>4</b>	Spare	OFF	Leave in the OFF position.

### SW 2 Switch Definitions:

**SW 2-Switch 1 and 2:** These work in conjunction with each other and will activate the relay on the circuit board **ONLY** when the gate is not closed. Switch 1 **MUST** be OFF and Switch 2 **MUST** be ON. **DO NOT** use any other switch combinations.

**SW 2-Switch 3:** Not used, leave in the OFF position.

**SW 2-Switch 4:** Spare switch. Leave in OFF position.

## 3.3 Limit Sensors Adjustment - Select your specific operator

The limit sensors on the operator **MUST** be adjusted to control the travel of the gate and to precisely set the **full** open and **full** closed position of the gate. Use **ONLY** the limit sensor instructions for your **SPECIFIC** operator type (6003, 6004, 6005 or 6400). This feature is especially useful in applications where the gate opens partially, such as on a curved driveway.

### 6003 Limit Sensors ONLY

**Power to the circuit board must be ON when adjusting the limit sensors.**

- A** Manually un-lock actuator arm with key and remove limit cover with 4 screws.
- B** Manually move the gate to the desired open or closed position. Loosen limit nut and slowly slide the limit assembly until the corresponding **LIMIT** LED on the circuit board lights up and tighten nut. Manually move the gate to other position. Repeat process with the other limit assembly.

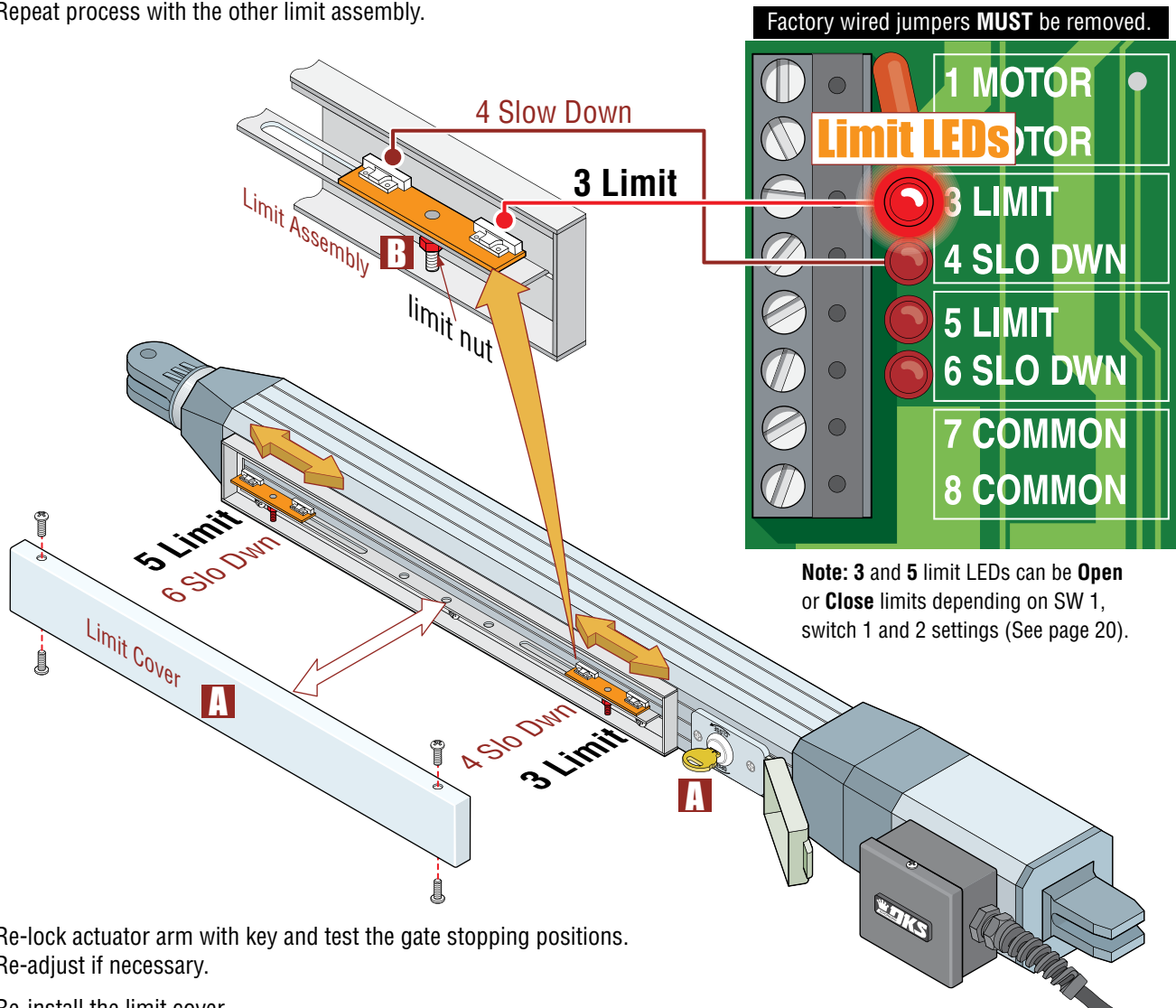

- C** Re-lock actuator arm with key and test the gate stopping positions. Re-adjust if necessary.
- D** Re-install the limit cover.
- E** Adjust the secondary actuator limit sensors if dual actuators have been installed. SW 1, switch 2 controls secondary actuator opening direction. SW 1, switch 7 **MUST** be ON when using dual actuators (See page 20).

**IMPORTANT: The operator MUST OPEN GATE upon initial power up and OPEN command.**

If the operator closes gate after giving first open command, shut off power and reverse DIP-switch SW1, switch 1 setting otherwise operator will **NOT** function correctly.

# 3.3 Limit Sensors Adjustment Continued

## 6004 Limit Switches ONLY

**Power to the circuit board must be ON when adjusting the limit sensors.**

The operator **MUST OPEN GATE** upon initial power up and **OPEN** command.

If the operator closes gate after giving first open command, shut off power and reverse DIP-switch SW1, switch 1 setting otherwise operator will **NOT** function correctly.

- A** With operator cover removed, un-lock operator with release tool to release arm.
- B** Manually move the gate to the desired open or closed position. Loosen adjustment screw and slowly spin the appropriate limit ring until the corresponding **LIMIT** LED on the circuit board lights up, then tighten screw. Manually move the gate to other position. Repeat process with the other limit ring.
- C** Re-lock operator with release tool and test the gate stopping positions. Re-adjust if necessary.
- D** Re-install the operator cover.

**Limit Switch Adjustment Note:**  
Two thru-bolts 13 mm can be loosened to allow the electronic pallet to be moved around a little. **Make sure ALL 4 limit switches make good contact with the 2 limit rings.**

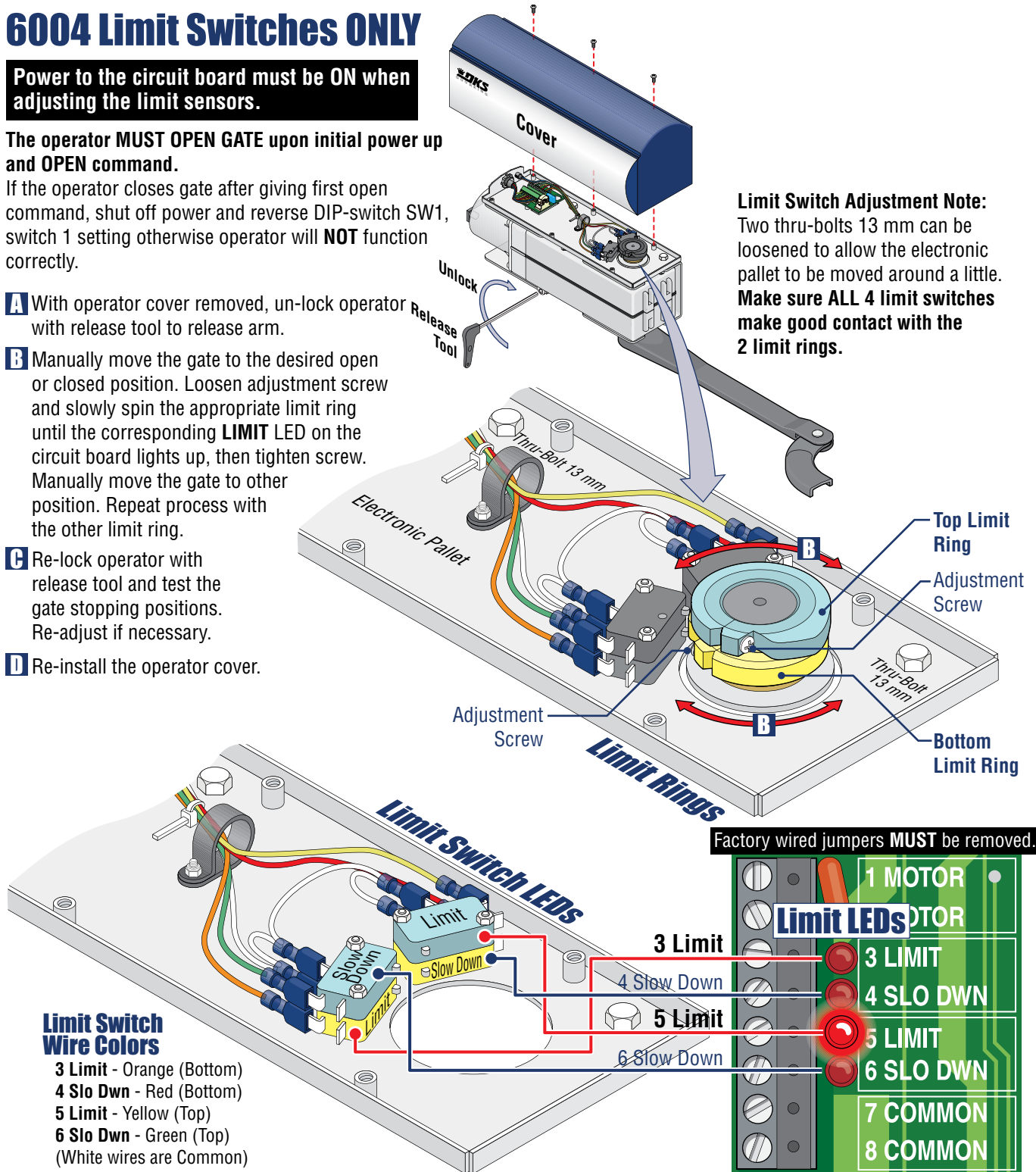

**E** Adjust the Secondary operator limit rings if dual operators have been installed. SW 1, switch 2 controls secondary operator opening direction. SW 1, switch 7 **MUST** be ON when using dual operators (See page 20).

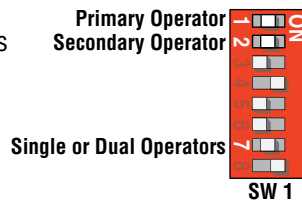

**Note:** 3 and 5 limit LEDs can be **Open** or **Close** limits depending on SW 1, switch 1 and 2 settings (See page 20).



# 3.3 Limit Sensors Adjustment Continued

## 6005 Limit Switches ONLY

**Power to the circuit board must be ON when adjusting the limit sensors.**

Factory wired jumpers **MUST remain connected** as shown. SLO DWN LEDs are always lit.

- A** Manually release 6005. See page 35.
- B** Remove the limit cover with one screw.
- C** Manually move the gate to the closed position. adjust **CLOSE** screw:  
Clockwise increases the power shaft distance.  
Counter-clockwise reduces distance.  
**5 LIMIT LED** on the circuit board lights up when **CLOSE** switch has been activated.
- D** Manually move the gate to **OPEN** position. adjust **OPEN** screw:  
Counter-clockwise increases the power shaft distance.  
Clockwise reduces distance.  
**3 LIMIT LED** on the circuit board lights up when **OPEN** switch has been activated.
- E** Re-lock 6005 and re-install the limit cover.
- F** Adjust the secondary 6005 limit sensors if dual actuators have been installed. SW 1, switch 2 controls secondary 6005 opening direction. SW 1, switch 7 **MUST** be ON when using dual actuators (See page 20).

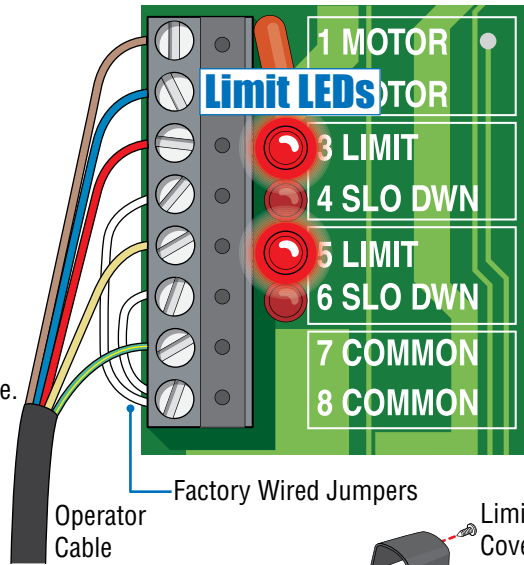

**Notes:**  
**3 LIMIT LED** is ON in **OPEN Gate Position**.  
**4 SLO DWN LED** will **NOT** light during open cycle.  
**5 LIMIT LED** is ON in **CLOSE Gate Position**.  
**6 SLO DWN LED** **WILL** light during close cycle.

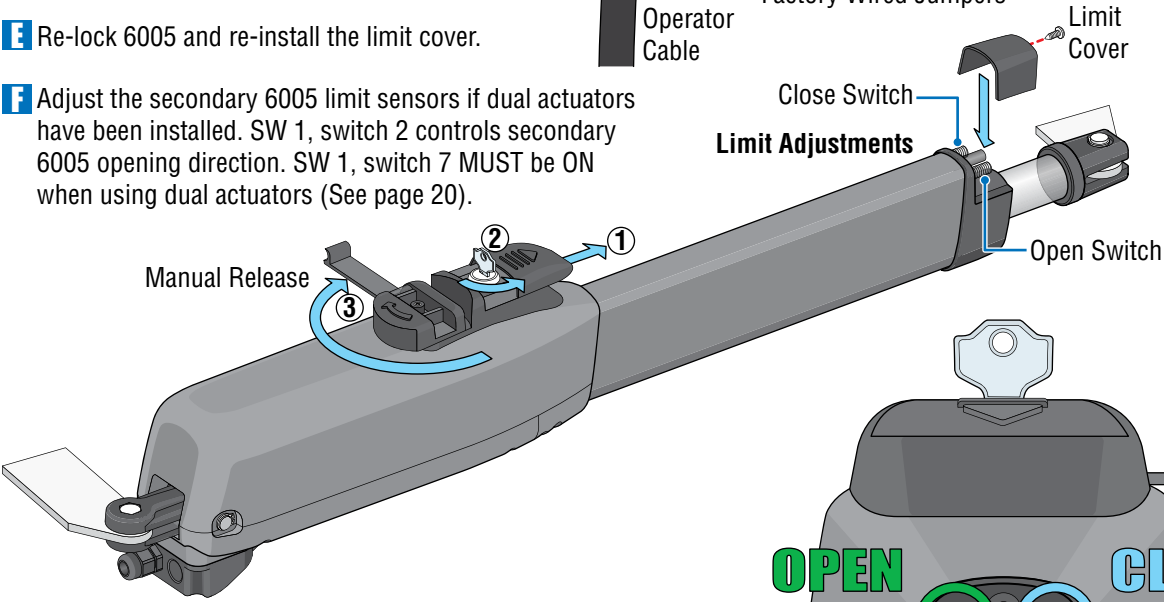

When finished setting limits, cycle operator a few times and re-adjust the open and close positions if necessary.

### End View

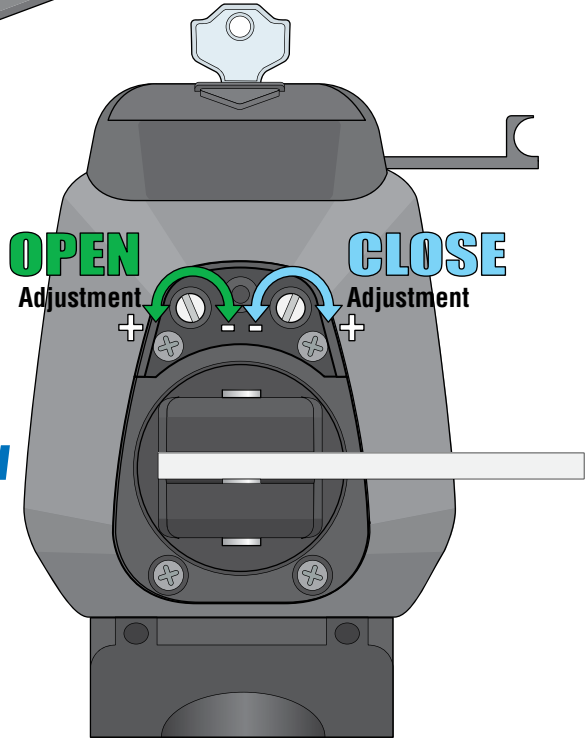

**IMPORTANT: The operator MUST OPEN GATE upon initial power up and OPEN command.**  
 If the operator closes gate after giving first open command, shut off power and reverse DIP-switch SW1, switch 1 setting otherwise operator will **NOT** function correctly.

# 3.3 Limit Sensors Adjustment Continued

## 6400 Limit Sensors ONLY

**Power to the circuit board must be ON when adjusting the limit sensors.**

**A** With operator cover plate removed, un-lock release handle and pull handle to release gate.

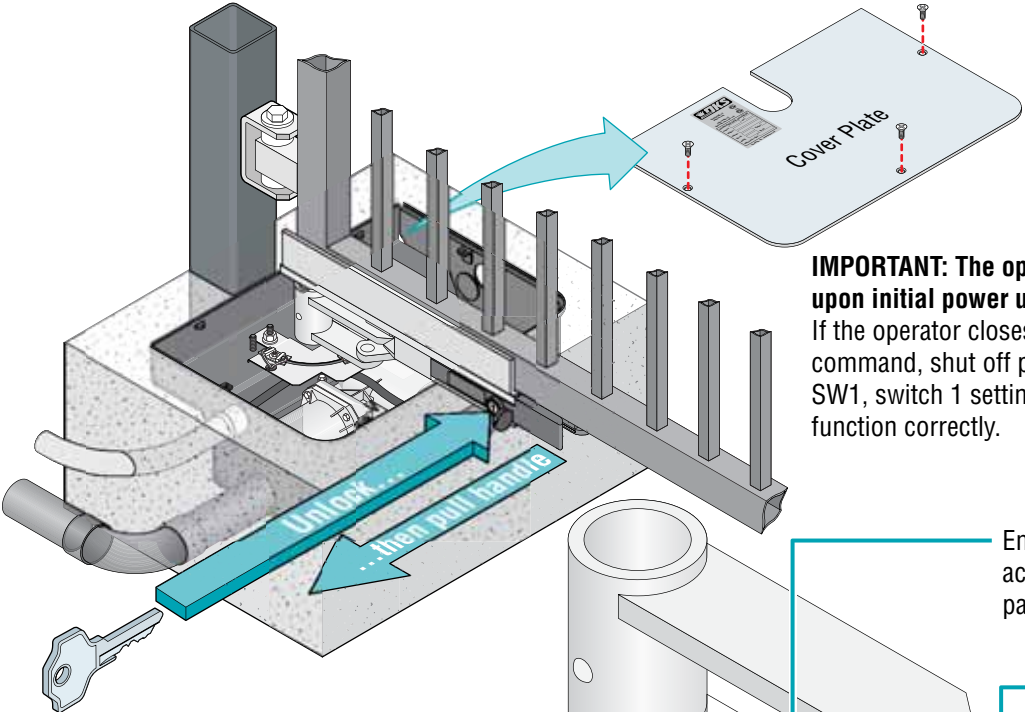

**IMPORTANT: The operator MUST OPEN GATE upon initial power up and OPEN command.** If the operator closes gate after giving first open command, shut off power and reverse DIP-switch SW1, switch 1 setting otherwise operator will **NOT** function correctly.

**B** Manually move the gate to the desired open or closed position. Loosen limit nut and slowly slide the limit assembly until the corresponding **LIMIT LED** on the circuit board lights up and tighten nut. Manually move the gate to other position. Repeat process with the other limit assembly.

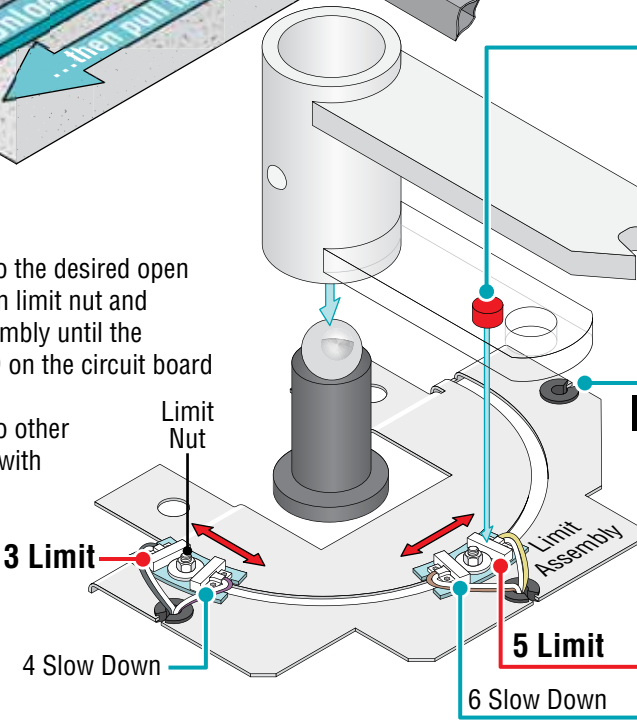

Embedded magnet on underside activates limit sensors when it passes over them.

Limit assembly positions may vary depending on the operator's drive motor orientation. Limit sensor wire color LEDs remain the same.

**C** Re-lock release handle with key and test the gate stopping positions. Re-adjust if necessary.

**D** Re-install the operator cover plate.

**E** Adjust the Secondary operator limit sensors if dual operators have been installed. SW 1, switch 2 controls secondary operator opening direction. SW 1, switch 7 **MUST** be ON when using dual operators (See page 20).

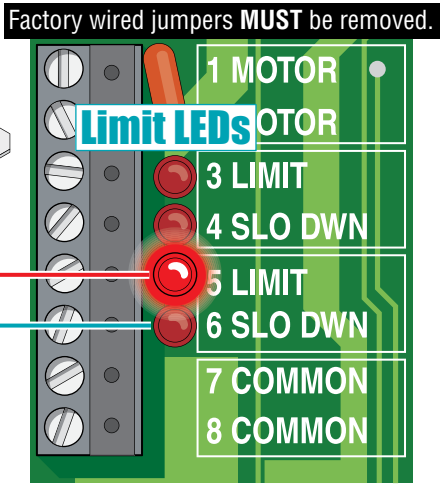

### Limit Sensor Wire Color LEDs

- 3 Limit LED - Gray/White
- 4 Slo Dwn LED - Purple/White
- 5 Limit LED - Yellow/White
- 6 Slo Dwn LED - Brown/White

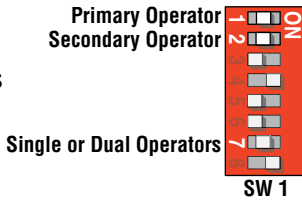

**Note: 3 and 5 limit LEDs can be Open or Close limits depending on SW 1, switch 1 and 2 settings (See page 20).**

## 3.4 Inherent Reverse Sensor Adjustment

This vehicular gate operator is equipped with an inherent (Built-In) adjustable reversing sensor (Type A) that is used as an entrapment sensing system according to the UL 325 standards. The gate will reverse direction upon encountering an obstruction in either the **opening or closing gate cycle**. For the reverse system to function correctly, the gate must be properly installed and work freely in both directions. A good set of roller bearing hinges is essential for proper swing gate operation.

The ideal adjustment will allow the operator to move the gate through its entire travel cycle without reversing, but will reverse upon contact with an obstruction with no more than 40 Lbs of force. This force can be measured with a gate scale.

The amount of force required for the gate to reverse direction depends on the reverse sensitivity potentiometer.

### Adjust the operators reversing sensitivity:

**CAUTION:** Keep pedestrians and vehicles clear of the gate while adjusting and testing sensors!

#### While operator has power:

- 1 Press the “Push to Operate” button to **OPEN** the gate.

Note: “Push to Operate” button will use the Auto-Close timer if turned ON (SW 1, switch 4 **ON**).

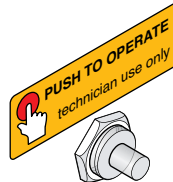

- 2 While gate is opening, slowly rotate PRM - **Primary** reverse sensor clockwise until the **reverse LED lights up** and the gate reverses direction. Rotate the primary reverse sensor back counter-clockwise approximately 1/8 turn to decrease the sensitivity (LED will turn off).

Note: The LED will light up during the first seconds of gate travel. Wait until it turns off before adjusting the reverse sensor.

- 3 Press the “Push to Operate” button (or wait for Auto-Close timer to time-out if turned ON) and **CLOSE** the gate. Make sure the gate closes completely. If it reverses and opens (LED will light up), rotate the primary reverse sensor counter-clockwise a little more to decrease the reverse sensitivity (LED will turn off). Cycle the gate a few times to be sure that it cycles completely in **BOTH** directions, re-adjusting the primary sensor as necessary.

#### Dual Operators:

Secondary operator must be individually adjusted if dual operators have been installed. Use the **SEC - Secondary** reverse sensor.

#### Test the operators reversing sensitivity:

Place an immobile object along the gate path, allowing the gate to strike it while in the **open** or **close** cycle. The gate must reverse direction after striking the object. If it does not, increase the reverse sensitivity (steps **2** and **3**) and repeat this test until the correct sensitivity has been set for the **OPEN** and **CLOSE** directions.

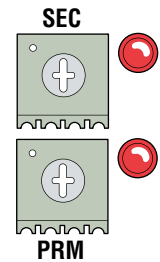

Note: The LED will turn on briefly when power is turned on.

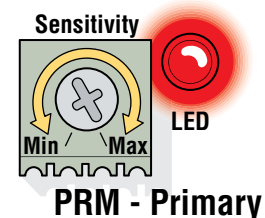

**Safety Note:** The LED will remain ON after a cycling gate gets obstructed during **normal** operation to indicate that the reverse sensor has been tripped. Always check the gate area for possible obstructions before putting operator back in service.

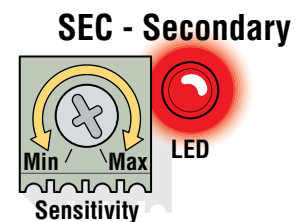

## 3.5 Shutdown Conditions

Under various entrapment conditions the operator will assume either a **SOFT** or **HARD (alarm)** shutdown. To determine what type of reset action is required, you will need to understand how the different entrapment conditions affect the gate operator.

### Soft Shutdown

---

This occurs in various situations where the inherent or external entrapment protection devices have been activated. In a soft shutdown condition, the operator **will not** respond to any input that was present when the entrapment protection device sensed or encountered an obstruction. If the gate stops at the open position, the operator **will not** respond to the automatic close timer and a “manual input” is required to close the gate.

- **Example 1** - A time clock keys the gate open in the morning and an entrapment protection device senses an obstruction prior to the gate reaching the full open position. If the entrapment is sensed by the inherent system, the gate will reverse and run back to the closed position. The time clock input is still present, but the gate will not re-open.

**Note:** In some systems, the time clock input comes from the telephone entry system relay. This same relay may also provide open commands for a card reader, MicroPLUS transmitters and the visitor telephone entry. If so, these devices will also be disabled in a soft shutdown condition.

- **Example 2** - If the gate is closing and an entrapment protection device is activated, the gate will either stop or reverse and run back to the open position, depending upon if the external or inherent device was activated. The automatic close timer will not close the gate.
- **Example 3** - If a moving vehicle runs over a loop while the gate is cycling open and hits the opening gate, the operator's inherent entrapment protection is activated. The gate will reverse direction and run back to the closed position. A soft shutdown condition **does not occur** and the loop provides an immediate reset of the operator. Once the loop area is clear and another open command is given, the gate will cycle open.

### Resetting a Soft Shutdown

In some conditions, a soft shutdown will reset as soon as the entrapment condition clears. For example, if a non-contact sensor (photo sensor) is sensing an obstruction, the operator will stop the gate and assume a soft shutdown condition. When the photo sensor clears (Obstruction is no longer there), the operator will return to normal operation.

When the operator is in a soft shutdown, activation of any “intended input” will reset the operator. An “intended input” includes any command input device, any standard safety input device and any loop input. Activating any of these inputs will reset the gate. At that point the gate will return to normal operation. If the gate is open, the automatic close timer will then time out and close the gate.

**When the operator is in a soft shutdown, the system WILL NOT shut down power to the circuit board until an “intended input” has been activated regardless of the length of time it takes to accomplish this (See the paragraph above).**

Continued on next page.

## 3.5 Shutdown Conditions Continued

### Hard Shutdown (Alarm Activated)

A hard shutdown condition occurs when: (1.) The inherent entrapment protection system (Type A) gets activated TWO consecutive times before the gate completes the open or close cycle. (2.) The reversing edge (Type B2) gets activated and reverses but before the gate completes the reverse cycle the inherent entrapment protection system (Type A) gets activated.

- **Example of a Hard Shutdown** - The gate is closing and the inherent entrapment protection system senses an obstruction and causes the gate to reverse direction. As the gate begins to run in the open direction, a second obstruction is sensed prior to the gate reaching the full open position. Once the second obstruction has been sensed, the operator will stop, **the audio alarm will sound and all standard inputs are shut down** (including open commands, safety commands, loop inputs, etc.).
  - **To silence the alarm**, press the reset button or after 5 minutes, the audio alarm will shut off but will “chirp” every 5 seconds. This indicates that the operator is in a hard shutdown condition (The reset button must be pressed **OR** turn power off to reset the operator and stop the alarm “chirping”).

### Resetting a Hard Shutdown

The operator is in a hard shutdown condition when the audio alarm is sounding OR “chirping” every 5 seconds.

- Before resetting a hard shutdown, determine why the shutdown occurred. Inspect the gate for any obstructions along its path that could have activated the inherent entrapment sensing system. Inspect the gate and gate hardware. If the gate is malfunctioning, **DO NOT** put it back into service until the problem can be corrected.

The audio alarm will sound for five minutes if the operator is not reset. After (5) five minutes the alarm will “chirp every 5 sec.” and the hard shutdown condition will remain in affect until the reset button is pushed OR power is shut-off to operator.

### Shutting OFF Alarm

DoorKing operators have a built-in alarm reset push button on the circuit board. Activating this button will return the gate operator to normal operation, but **will not** activate the gate operator. Also, power can be shut-off to the gate operator to reset it.

When the operator is in a hard shutdown, the system **WILL NOT** shut down power to the circuit board (idle time) until the reset button has been activated regardless of the length of time it takes to accomplish this.

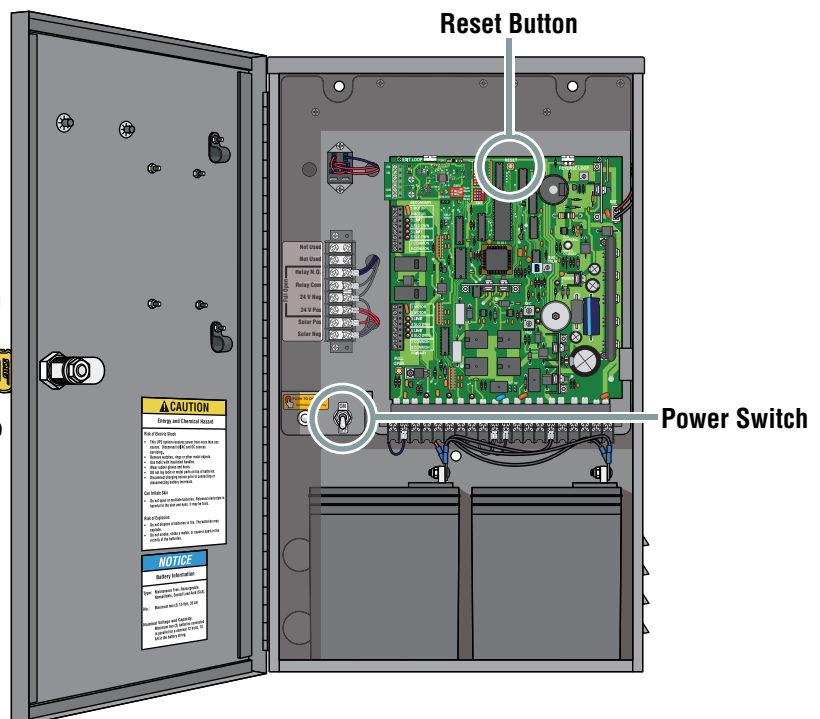

Once the gate has been reset, an open or close command is needed to start the gate operator. Most activating commands will cause the gate operator to cycle to the open position. This includes activation of a key switch or open command and activation of the automatic exit loop (If used). Activation of a close command will run the gate to the closed position.

# SECTION 4 - MAINTENANCE AND TROUBLESHOOTING

Inspection and service of this gate operator by a qualified technician should be performed anytime a malfunction is observed or suspected. High cycle usage may require more frequent service checks.

## 4.1 Maintenance

When servicing the gate operator, always check any external reversing devices (loops, photo sensors, etc.) for proper operation. If external reversing devices cannot be made operable, do not place this operator in service until the malfunction can be identified and corrected.

**Always check the inherent reversing system when performing any maintenance. If the inherent reversing system cannot be made operable, remove this operator from service until the cause of the malfunction is identified and corrected. Keeping this operator in service when the inherent reversing system is malfunctioning creates a hazard for persons which can result in serious injury or death should they become entrapped in the gate.**

When servicing the gate operator, be sure that the power switch is turned OFF.

Operator Component	Maintenance	Monthly Interval		
		1	6	12
<b>Warning Signs</b>	Check that warning signs are on BOTH sides of the gate area.	✓		
<b>Alarm</b>	Activate the primary (inherent) reverse system by blocking the gate with a solid object. When the gate reverses, block the gate in the opposite direction prior to the limit being reached. The entrapment alarm should activate. Press the reset button or turn power off to silence the alarm.	✓		
<b>Batteries</b>	Check the batteries for any leakage or loose connections. Batteries should be replaced every two years.	✓		
<b>Solar Panel</b>	Check the panel for any debris on it. Clean the panel with water.	✓		
<b>Fire Dept.</b>	Check emergency vehicle access device for proper operation.	✓	✓	
<b>Gate</b>	Inspect for damage. Check gate hinges for wear and grease if necessary.		✓	
<b>Primary Reverse System</b>	Check that the gate reverses on contact with an object in both the opening and closing cycles. Adjust the reversing sensor if necessary.	✓		
<b>Loop(s)</b>	Check vehicular reverse loops for proper operation.	✓		
<b>Manual Release</b>	Check manual release for proper operation.	✓		
<b>External Entrapment Device</b>	Check external reverse device(s) stop or reverse the gate when activated.	✓		
<b>Complete System</b>	Complete check of gate and gate operating system.			✓

## 4.2 Diagnostics Check

Have the following diagnostic tools available: VOM meter with minimum voltage memory or min-max range to check voltage and continuity. Meg-ohm meter capable of checking up to 500 megohms of resistance to properly check ground loop integrity. A malfunction can be isolated to one of the following:

- Gate Operator
- Loop System
- Keying Devices.

**Disconnect all external inputs to the circuit board.**

1. Check the input indicator LED's. They should only come ON when a keying device (card reader, push button, etc.) is activated. If any of the input LED's are ON continuously, this will cause the gate operator to hold open. Disconnect the keying devices one at a time until the LED goes OFF (see troubleshooting guide).
2. If the operator stops or holds open, check external entrapment protection devices for any shorts or malfunction.
3. A malfunction in a loop or loop detector can cause the gate operator to hold open, or not detect a vehicle when it is present over the loop. Pull the loop detector circuit boards from the loop ports on the operator circuit board. If the malfunction persists, the problem is not with the loop system. For more information refer to the loop detector instruction sheet and the DoorKing Loop and Loop Detector Information Manual. Continued on next page.

## 4.2 Diagnostics Check Continued

4. Check that there are no shorted or open control wires from the keying devices to the gate operator. If a keying device fails to open the gate, momentarily jumper across terminals 1 and 2 on the control board. If the gate operator starts, this indicates that a problem exist with the keying device and not with the gate operator.

5. Check the supply voltage and batteries. A voltage drop on the supply line (usually caused by using too small supply voltage wires) will cause the operator to malfunction. Batteries should be fully charged for proper operation, replace batteries every two years on average.

## 4.3 Troubleshooting

Symptom	Possible Solution(s)
Operator(s) will not run. Power LED is OFF.	<ul style="list-style-type: none"> <li>• Check that AC power to the operator is turned ON.</li> <li>• Check that <b>ANY</b> access control device wired to operator (radio receiver, key switch, exit loop or safety opening device) has a relay contact time of <b>AT LEAST 1 SECOND</b> to bring the circuit board out of "idle time" and operate gate.</li> <li>• Check battery</li> <li>• Check for 24 VAC at terminals 19 and 20. If voltage measures OK, check the terminal strip or replace the circuit board.</li> </ul>
Operator(s) will not run. Power LED is ON.	<ul style="list-style-type: none"> <li>• Insure that a minimum of one (1) external entrapment protection device is connected in <b>EACH</b> entrapment area and the inputs are connected and enabled (UL 325 DIP-switches are turned ON).</li> <li>• Momentarily jumper terminal 1 to terminal 2. If the input LED does not come ON, check the terminal strip or replace the circuit board. If LED does come ON, proceed to next steps.</li> <li>• Check the fuses.</li> <li>• <b>Check Motor(s):</b> Remove the circuit board. With two 14 AWG insulated jumper wires, momentarily jumper the battery terminals to the motor terminals (1, 2) of the Primary operator connector. The operator should run. Swap the two wires at the terminal strip. The operator should run in the opposite direction. Repeat these steps using the Secondary operator connector.</li> <li>• If the operator(s) run in both directions in the step above, replace the control board. If the operator(s) do not run, or run in only one direction, problem can be a bad operator, wire connections from the control board to the operator(s) or a bad control board.</li> </ul>
Operator will not run, entrapment protection input(s) LED is ON.	<ul style="list-style-type: none"> <li>• The entrapment protection device has a fault or the wiring to it is shorted.</li> </ul>
Operator will not run, entrapment protection input(s) LED is Blinking.	<ul style="list-style-type: none"> <li>• The entrapment protection device is not connected or the wiring to it is open.</li> </ul>
Gate opens a short distance, then stops and reverses.	<ul style="list-style-type: none"> <li>• Check the reversing sensitivity.</li> <li>• Check the secondary safety devices.</li> <li>• Disconnect the gate from the gate operator and check that the gate swings freely without any binding.</li> <li>• Continue troubleshooting or replace the circuit board.</li> </ul>

## 4.3 Troubleshooting Continued

Symptom	Possible Solution(s)
Gate opens but will not close.	<ul style="list-style-type: none"> <li>• Check the input LEDs. Any ON will hold the gate open and indicates a problem with a keying device.</li> <li>• Check the secondary safety devices. Any activated will hold the gate open and indicates a problem with the safety device.</li> <li>• Check the loop detectors. Any activated can hold the gate open and indicates a problem with the loop detector or ground loop.</li> <li>• Operator may be in a “soft shutdown.” Activate any keying device to determine if operator returns to normal operation.</li> <li>• If automatic close is desired, be sure SW 1, switch 4 is ON.</li> </ul>
Gate closes but will not open.	<ul style="list-style-type: none"> <li>• Operator may be in a “soft shutdown.” Check input LEDs. If any are ON, momentarily disconnect, then re-connect the wire going to the respective terminal. Operator should open.</li> <li>• Check to be sure that the operator is running in the proper direction. Turn power OFF, and then back ON. Activate a keying device. Operator should run in the open direction. If operator runs in the close direction, turn power OFF and change direction switch SW 1, switches 1 and/or 2. Go to above section if operator now opens but will not close.</li> <li>• Be sure that the respective LED on the control board lights when the keying device connected to the respective terminal is activated. If LED does not light, momentarily place a jumper wire from terminal 1 to the input terminal being checked. If LED lights and gate opens, problem is with the keying device. If LED does not light, replace control board.</li> <li>• Check motor as described above “Operator(s) will not run. Power LED is ON”.</li> </ul>
Gate starts to close, then reverses to open.	<ul style="list-style-type: none"> <li>• Disconnect the gate from the operator and check that the gate operates freely without any binding.</li> <li>• Check the loop detector LED’s and input LED’s. Any that flash ON will cause the gate to reverse.</li> <li>• Continue troubleshooting or replace the circuit board.</li> </ul>
Gate closes and opens continuously.	<ul style="list-style-type: none"> <li>• Check for any input or loop detector LED’s that are ON.</li> <li>• Check that the operator is running in the proper direction (see “gate closes but will not open”).</li> <li>• Check the SELF TEST jumper, see page 18.</li> </ul>
Alarm sounds for 5 minutes and then beeps once every 5 seconds. Operator will not run.	<ul style="list-style-type: none"> <li>• Operator is in a “hard shutdown” condition. Reset switch must be activated to return operator to normal operation, see Hard Shutdown Section 3.5, page 27.</li> </ul>
Operator has intermittent functionality problems that vary.	<ul style="list-style-type: none"> <li>• The 24 V POS terminal 250 mA power has been exceeded. Check total amp draw of connected device(s).</li> </ul>



## 4.4 Accessory Items

### UL 325 Monitored Entrapment Protection Devices available for the Solar Control Boxes.

#### Type B2 Contact Sensors (Reversing Edge)

Miller Edge Sensing Edges - all models with a T2 (resistive) termination.  
Miller Edge wireless monitored transmitter/receiver kit model RB-G-K10  
ASO GMBH Sentir GF Series sensing edges

#### Type B1 Non-contact Sensors (Photo Cell)

Miller Edge Reflective-Guard Model RG  
Miller Edge Prime-Guard Model PG  
EMX Industries Model IRB-MON  
EMX Industries Model IRB-RET  
Omron Model E3K-R10K4  
Seco-Larm Model E-936-S45RRGQ  
Seco-Larm Model E-960-D90GQ

#### Monitored Expansion Kit

Miller Edge Multi-Input Module Model MIM-62

### Accessory items available for the Solar Control Boxes.

**Low Current Draw External Loop Detector** - Detectors are solar friendly and mount into solar control box.  
Single channel detector - P/N 9402-050

**24 Volt 10 Watt Solar Panel.** P/N 2000-077. One (1) panel required for the 12 Volt - 18 Amp/Hr batteries.

**24 Volt 20 Watt Solar Panel.** P/N 2000-076. One (1) panel required for the 12 Volt - 35 Amp/Hr batteries.

**12 Volt 18 Amp Hour Battery.** P/N 1801-004. Two (2) required.

**12 Volt 35 Amp Hour Battery.** P/N 1801-005. Two (2) required.

# Solar Control Box

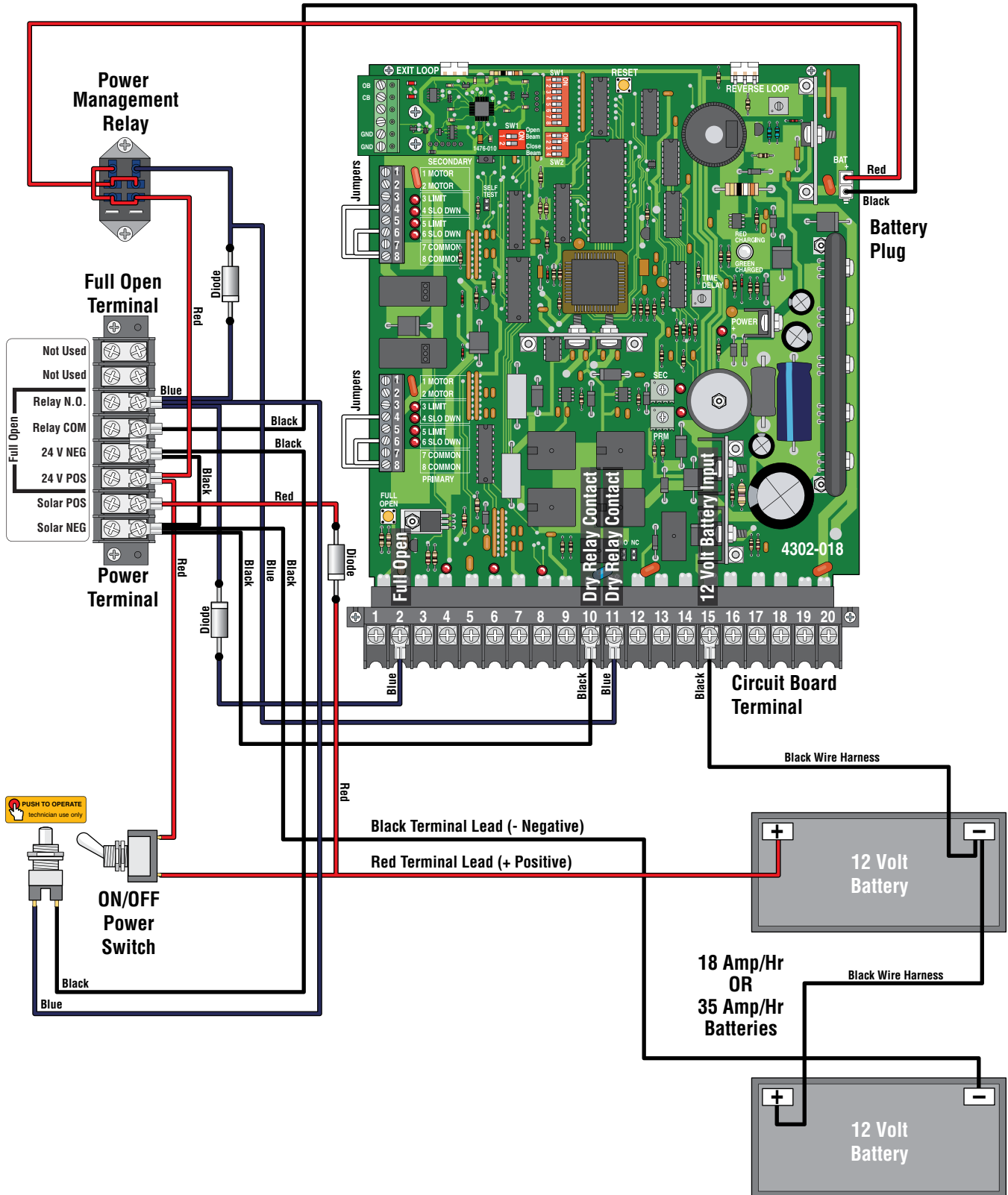

# IMPORTANT INFORMATION FOR OWNER

## Shut-Off Power to Operator OR Shut-Off Alarm

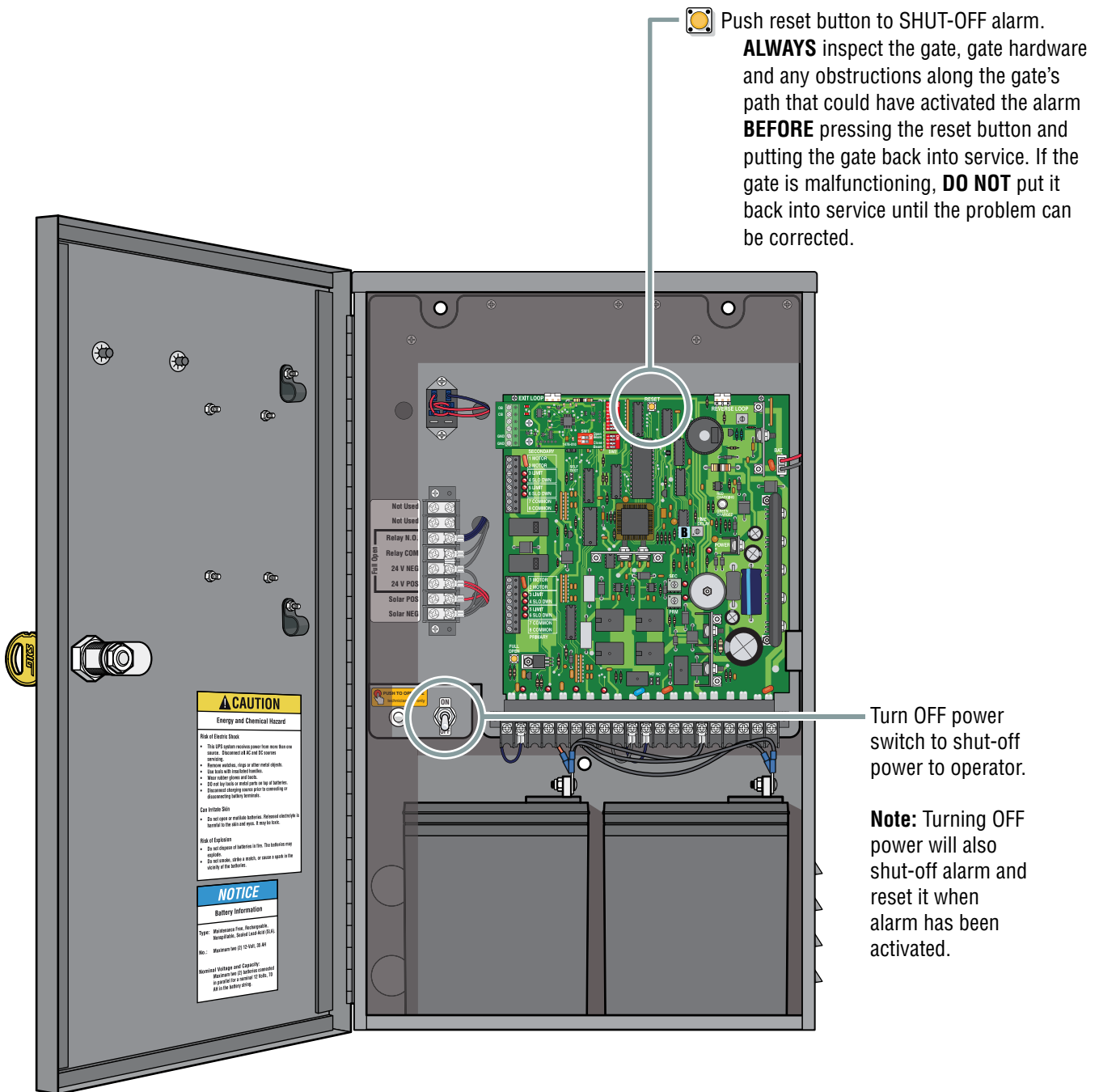

# IMPORTANT INFORMATION FOR OWNER

## Manually Operating the Gate (NO Power)

Choose your operator model and follow directions to un-lock the operator and manually move the gate.

### 6003 Manual Release ONLY

**ALL power to the operator must be OFF BEFORE manually operating gate (See previous page).**

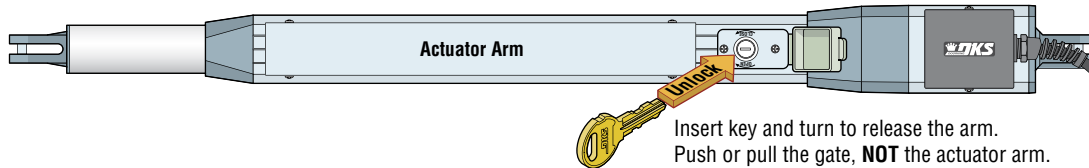

Insert key and turn to release the arm.  
Push or pull the gate, **NOT** the actuator arm.

### 6005 Manual Release ONLY

**ALL power to the operator must be OFF BEFORE manually operating gate (See previous page).**

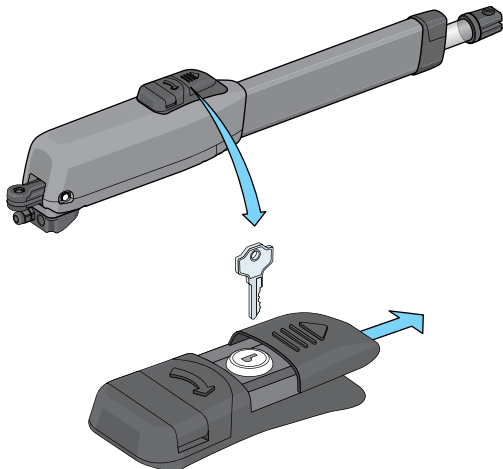

1. Slide door open and insert key.

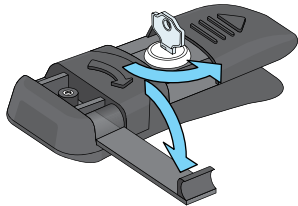

2. turn key 90° and flip handle out.

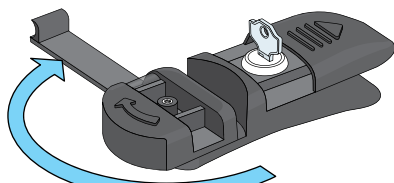

3. Rotate handle 180°.

Gate can now be manually moved.  
Push or pull the gate, **NOT** the operator.

### 6004 Manual Release ONLY

**ALL power to the operator must be OFF BEFORE manually operating gate (See previous page).**

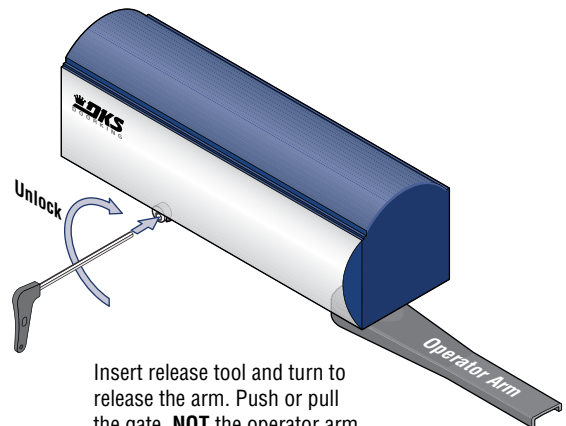

Insert release tool and turn to  
release the arm. Push or pull  
the gate, **NOT** the operator arm.

### 6400 Manual Release ONLY

**ALL power to the operator must be OFF BEFORE manually operating gate (See previous page).**

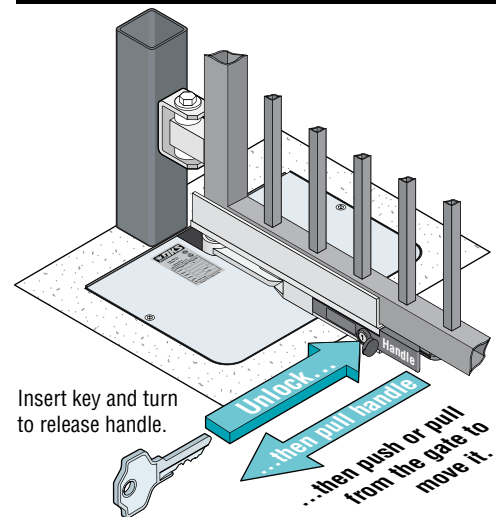

Insert key and turn  
to release handle.

...then pull handle  
...then push or pull  
from the gate to  
move it.



# Wiring / Owner's Manual

# Solar Control Box for 6003, 6004, 6005 and 6400 gate operators

Use this manual for circuit board 4302-018 Revision A or higher.

4302-067-B-7-18

Entrapment Protection must be provided for the gate system where the risk of entrapment or obstruction exists. The operator will NOT run without one or more monitored type B1 or B2 entrapment protection devices in EACH entrapment area.

**UL 325 August 2018 Standard**



THIS PRODUCT IS TO BE INSTALLED AND SERVICED BY A TRAINED GATE SYSTEMS TECHNICIAN ONLY.  
Visit [www.dkslocator.com](http://www.dkslocator.com) to find a professional installing and servicing dealer in your area.

[www.doorking.com](http://www.doorking.com)

DoorKing, Inc.  
120 S. Glasgow Avenue  
Inglewood, California 90301  
U.S.A.

Phone: 310-645-0023  
Fax: 310-641-1586