

Wiring / Owner's Manual

115 VAC Control Boxes for

6003, 6004, 6005 and 6400 gate operators

Use this manual for circuit board 4302-018 Revision A or higher.

4302-065-Z-1-19

Entrapment Protection must be provided for the gate system where the risk of entrapment or obstruction exists. The operator will NOT run without one or more monitored type B1 or B2 entrapment protection devices in EACH entrapment area.

UL 325 August 2018 Standard

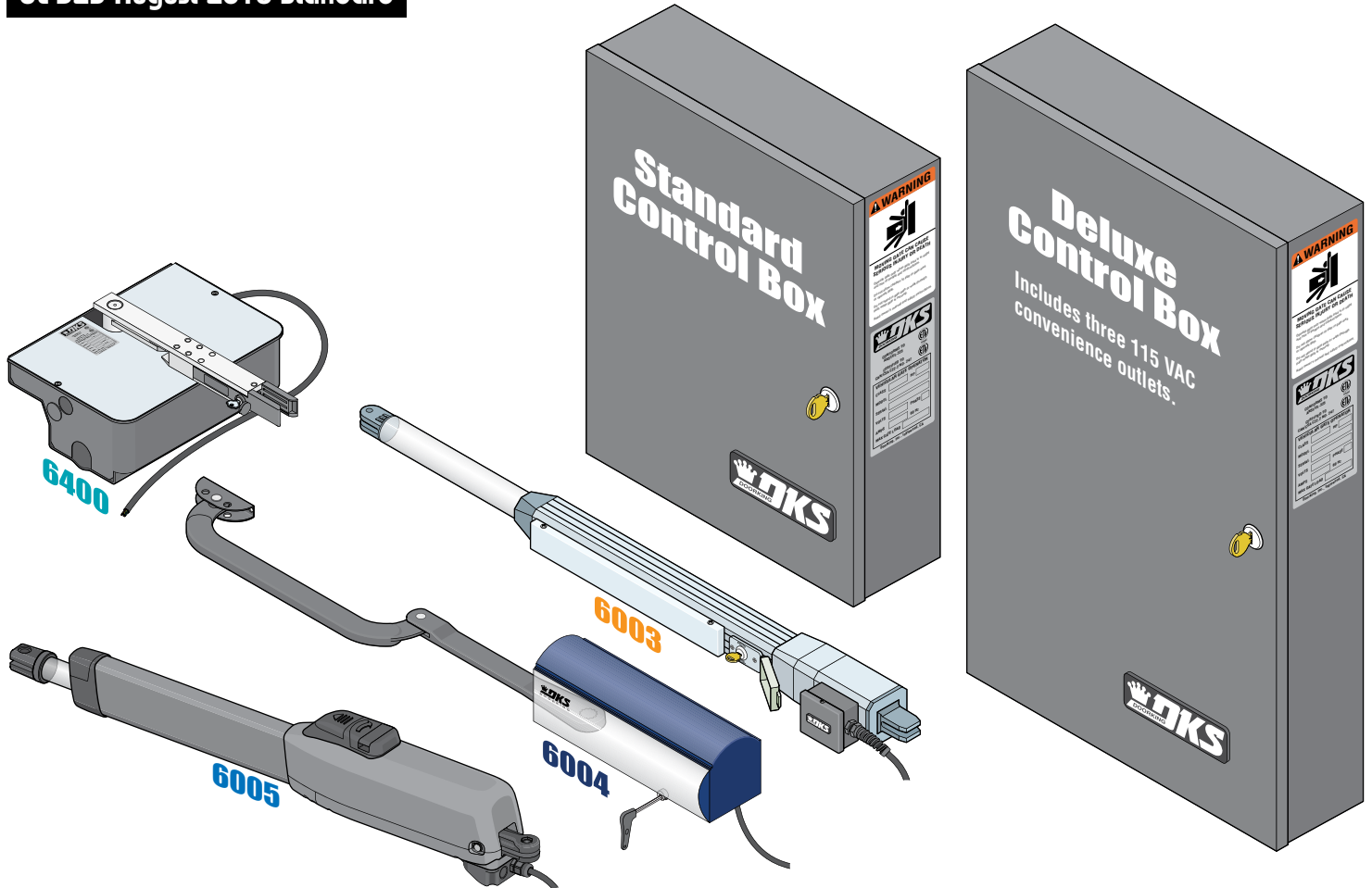

THIS PRODUCT IS TO BE INSTALLED AND SERVICED BY A TRAINED GATE/DOOR SYSTEMS TECHNICIAN ONLY.
Visit www.doorking.com/dealer-locator to find a professional installing and servicing dealer in your area.

Date Installed: _____

Installer/Company Name: _____

Phone Number: _____

Circuit Board
Serial Number
and Revision Letter: _____

Leave Manual with Owner

Copyright 2019 DoorKing®, Inc. All rights reserved.



Conforms To UL STD 325
Certified To CSA STD C22.2 # 247



QUICK GUIDE: DIP-Switches

See pages 17-18 for more info about DIP-switches.

Whenever any programming or switch setting on the control board is changed, press the reset button for new settings to take effect.

SW 1 (Top 8 Switches)			
Switch	Function	Setting	Description
1	Opening Direction of PRIMARY Operator		The operator MUST OPEN GATE upon initial power up and OPEN command. If the operator closes gate after giving open command, shut off power and reverse this switch setting otherwise operator will NOT function correctly.
	6003 ONLY		
	6004 ONLY	Left-Side	
	6005 ONLY		
	6400 ONLY		
2	Opening Direction of SECONDARY Operator		Same opening directions as illustrated above for the primary operator type. • Switch 2 will be the SAME setting as switch 1 for the 6003. • Switch 2 will be the OPPOSITE setting as switch 1 for the 6004, 6005 and 6400. Note: SW1, switch 7 MUST also be ON when using a secondary operator.
3	Exit Loop Port Output	OFF	Terminal #4 is output from plug-in exit loop detector installed in EXIT loop port.
	Open Input	ON (normal)	Terminal #4 is normal open command.
4	Auto-Close Timer	OFF	Auto-close timer is OFF. Manual input required to close gate.
		ON	Auto-close timer is ON. Adjustable from 1-23 seconds.
5	Reverse	OFF (normal)	Terminal #8 is a standard Reverse input.
	Not Used	ON	On setting is NOT used.
6	Overlapping Gates	OFF	Both operators start at the same time.
		ON	Secondary operator opens 1-2 seconds before primary operator. Vice-versa when closing.
7	Single	OFF	Switch must be OFF for single operator.
	Dual	ON	Switch must be ON when (dual) operators are used.
8	Input Power	OFF	Switch MUST be in the OFF position.
SW 2 (Bottom 4 Switches)			
1 and 2	Relay Operation	1-OFF 2-OFF	Relay activates when gate is fully open.
		1-OFF 2-ON	Relay activates when gate is not closed.
		1-ON 2-OFF	Relay activates when gate is opening and open. Shadow loop setting if used.
		1-ON 2-ON	Relay activates when gate is opening and closing.
3	Maglock	ON	1-2 second delay to disengage maglock.
	Solenoid lock	OFF	5 second delay to disengage solenoid lock.
4	Spare	OFF	Leave in the OFF position.

QUICK GUIDE: Terminal Descriptions

For specific wiring information, see page 13.

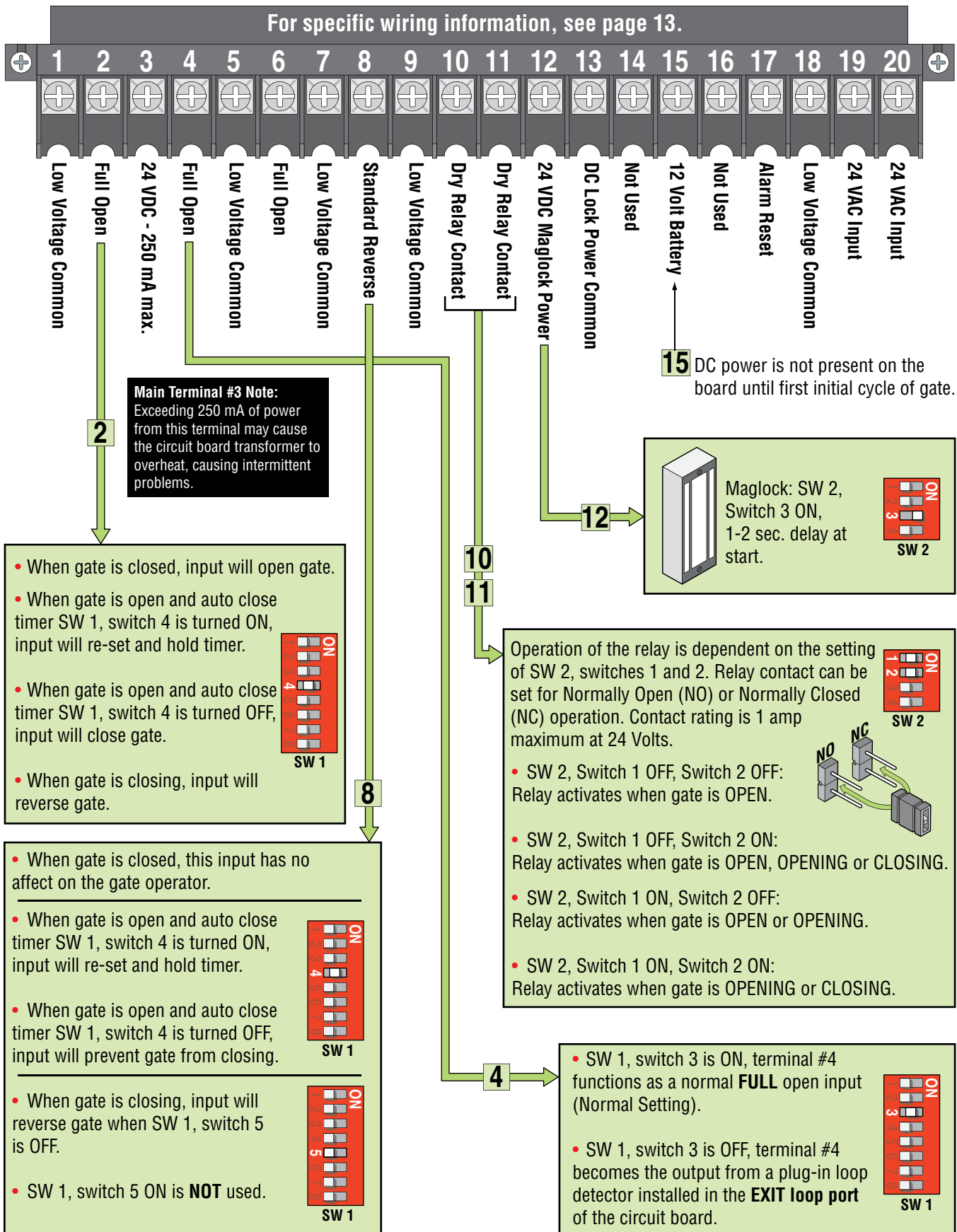

Main Terminal #3 Note:
Exceeding 250 mA of power from this terminal may cause the circuit board transformer to overheat, causing intermittent problems.

- When gate is closed, input will open gate.
- When gate is open and auto close timer SW 1, switch 4 is turned ON, input will re-set and hold timer.
- When gate is open and auto close timer SW 1, switch 4 is turned OFF, input will close gate.
- When gate is closing, input will reverse gate.

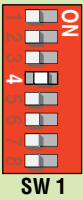

SW 1

- When gate is closed, this input has no affect on the gate operator.
- When gate is open and auto close timer SW 1, switch 4 is turned ON, input will re-set and hold timer.
- When gate is open and auto close timer SW 1, switch 4 is turned OFF, input will prevent gate from closing.
- When gate is closing, input will reverse gate when SW 1, switch 5 is OFF.
- SW 1, switch 5 ON is **NOT** used.

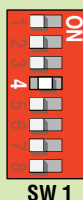

SW 1



SW 1

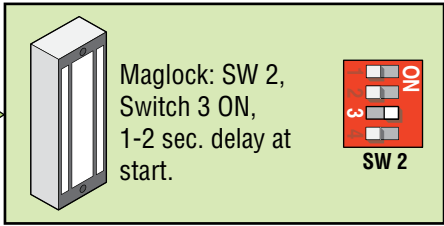

Maglock: SW 2, Switch 3 ON, 1-2 sec. delay at start.



SW 2

Operation of the relay is dependent on the setting of SW 2, switches 1 and 2. Relay contact can be set for Normally Open (NO) or Normally Closed (NC) operation. Contact rating is 1 amp maximum at 24 Volts.

- SW 2, Switch 1 OFF, Switch 2 OFF: Relay activates when gate is OPEN.
- SW 2, Switch 1 OFF, Switch 2 ON: Relay activates when gate is OPEN, OPENING or CLOSING.
- SW 2, Switch 1 ON, Switch 2 OFF: Relay activates when gate is OPEN or OPENING.
- SW 2, Switch 1 ON, Switch 2 ON: Relay activates when gate is OPENING or CLOSING.



SW 2

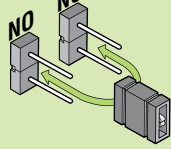

- SW 1, switch 3 is ON, terminal #4 functions as a normal **FULL** open input (Normal Setting).
- SW 1, switch 3 is OFF, terminal #4 becomes the output from a plug-in loop detector installed in the **EXIT loop port** of the circuit board.

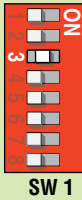

SW 1

115 VAC CONTROL BOXES SPECIFICATIONS

Class of Operation	Models 6003, 6004, 6005 and 6400 - UL325 Class I
Type of Gate	Residential Vehicular Automated Gates Only
Voltage / Phase	115 VAC 60 Hz Single Phase Input Power – 24 VDC Output Power to Gate Operators
Back-Up Power	24 VDC battery power during power outages.
Circuit Board Model	4302-018 revision A or higher.
Inherent Entrapment Protection Device	Inherent Reverse Sensor System (Type A)
External Entrapment Protection Device Inputs:	Monitored input connection for Non-contact Sensor - Photo Sensor (Type B1) Monitored input connection for Contact Sensor - Reversing Edge (Type B2)

Entrapment Protection must be provided for the gate system where the risk of entrapment or obstruction exists. The operator will not run without one or more monitored type B1 or B2 entrapment protection devices in EACH entrapment area.

Standard Control Box

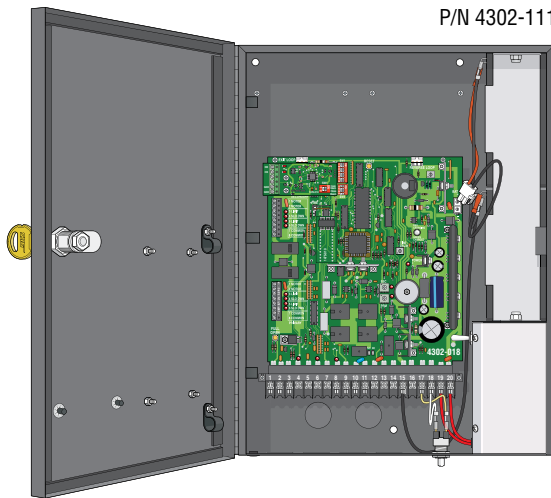

P/N 4302-111

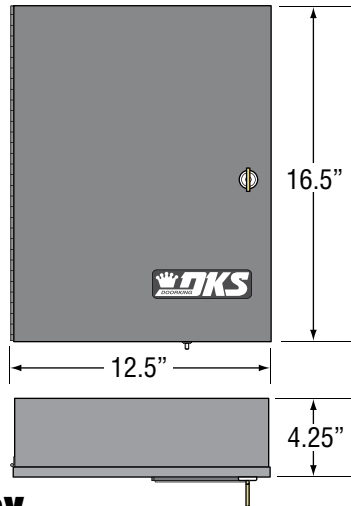

Type of wiring to be used on ALL external devices:
A) Type CL2, CL2P, CL2R, or CL2X.
B) Other cable with equivalent or better electrical, mechanical, and flammability ratings.

Deluxe Control Box

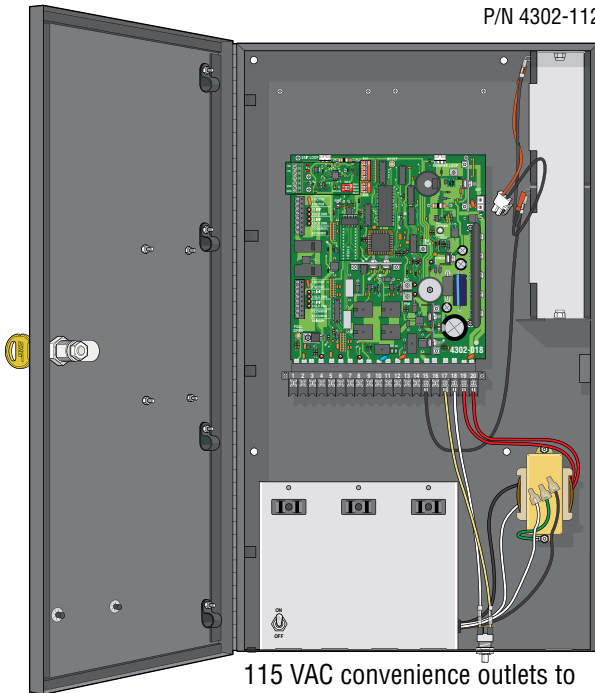

P/N 4302-112

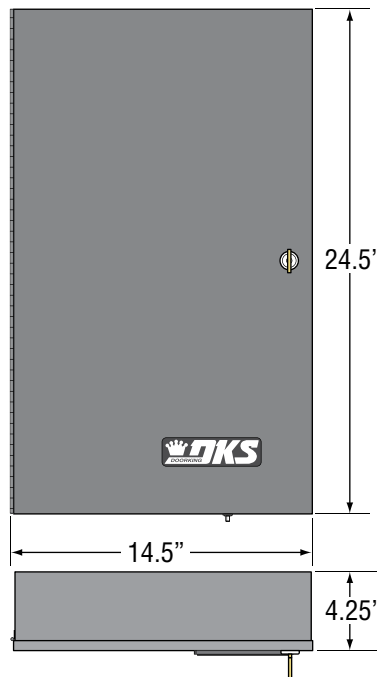

115 VAC convenience outlets to power auxiliary power transformers.

DoorKing, Inc. reserves the right to make changes in the products described in this manual without notice and without obligation of DoorKing, Inc. to notify any persons of any such revisions or changes. Additionally, DoorKing, Inc. makes no representations or warranties with respect to this manual. This manual is copyrighted, all rights reserved. No portion of this manual may be copied, reproduced, translated, or reduced to any electronic medium without prior written consent from DoorKing, Inc.

TABLE OF CONTENTS

IMPORTANT

115 VAC Control Boxes Specifications	Previous Page
Swing Gate Requirements	2-3
ASTM F2200 Standard for Gate Construction	4
Important Safety Instructions	4
Instructions regarding intended installation:	4
Important Notices	5
UL 325 Entrapment Protection	6
Glossary	7

SECTION 1 - WIRING

8

1.1 Control Box Wiring Overview	8
1.1 Wiring Operators to 4302-018 Circuit Board	9
1.2 Entrapment Protection Wiring	10-11
1.3 Main Terminal Description	12
1.4 Main Terminal Wiring	13
1.5 Loop Detector Wiring	14
1.6 High Voltage Wiring and Battery Connection	15

SECTION 2 - ADJUSTMENTS

16

2.1 3402 Circuit Board Description and Adjustments	16
2.2 DIP-Switches	17-18
2.3 Limit Sensors Adjustment - Select your specific operator	19-22
6003 Limit Sensors ONLY	19
6004 Limit Sensors ONLY	20
6005 Limit Sensors ONLY	21
6400 Limit Sensors ONLY	22
2.4 Inherent Reverse Sensor Adjustment	23
2.5 Shutdown Conditions	24-25
Soft Shutdown	
Hard Shutdown (Alarm Activated)	

SECTION 3 - MAINTENANCE AND TROUBLESHOOTING

26

3.1 Maintenance	26
3.2 Diagnostics Check	26-27
3.3 Troubleshooting	27
3.4 Accessory Items	28
115 VAC Standard or Deluxe Control Box Schematics	29

IMPORTANT INFORMATION FOR OWNER

30

Shut-Off ALL Power to Operator OR Shut-OFF Alarm	30
Manually Operating the Gate (NO Power)	31
Gate Operator's Monthly Check-Up	32

Swing Gate Requirements

The operator is intended for installation only on gates used for vehicles. Pedestrians must be supplied with a separate access opening. The pedestrian access opening shall be designed to promote pedestrian usage. Locate the gate such that persons will **NOT** come in contact with the vehicular gate during the entire path of travel of the vehicular gate.

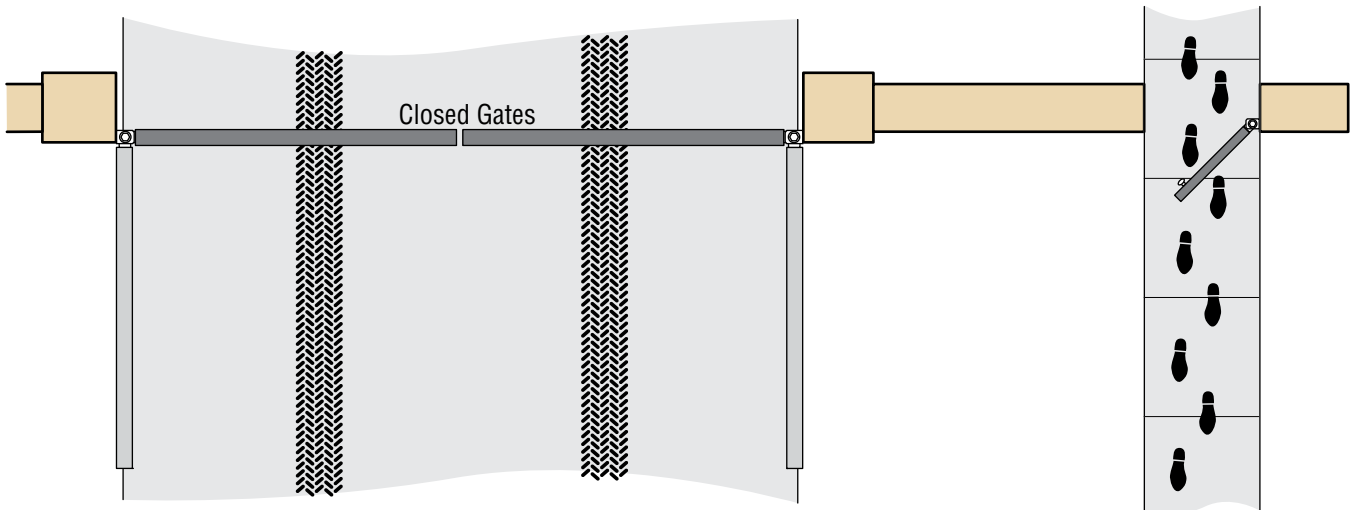

Entrapment Protection must be provided for the gate system where the risk of entrapment or obstruction exists. The operator will NOT run without one or more monitored type B1 or B2 entrapment protection devices in EACH ENTRAPMENT AREA.

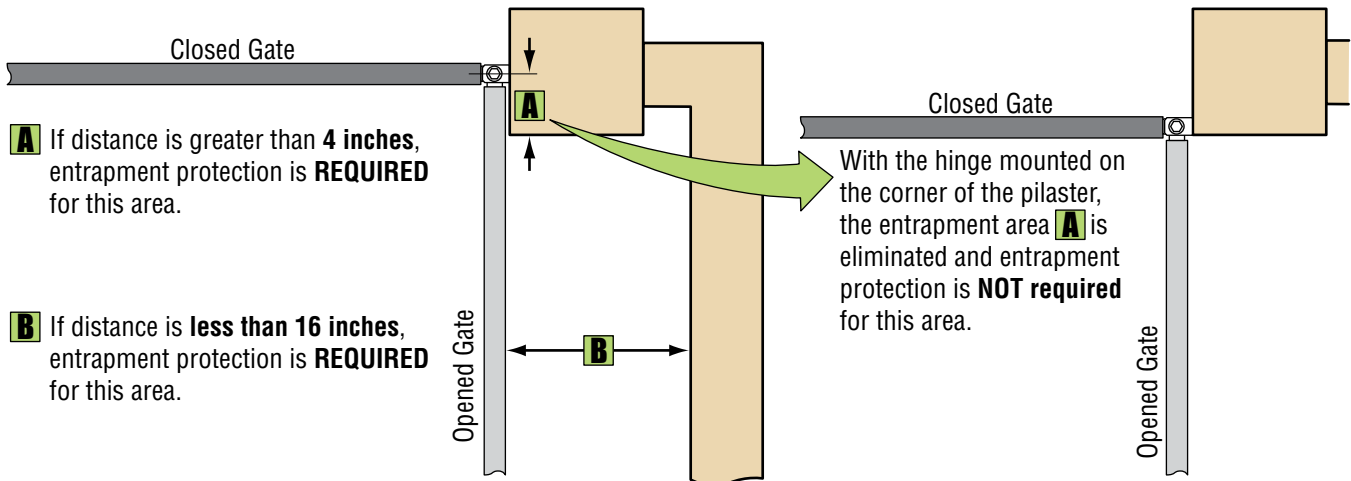

A If distance is greater than 4 inches, entrapment protection is **REQUIRED** for this area.

B If distance is less than 16 inches, entrapment protection is **REQUIRED** for this area.

With the hinge mounted on the corner of the pilaster, the entrapment area **A** is eliminated and entrapment protection is **NOT required** for this area.

C If bottom of gate is 4" to 16" above the ground at any part of the gate's traveling path, entrapment protection is **REQUIRED** for this area.

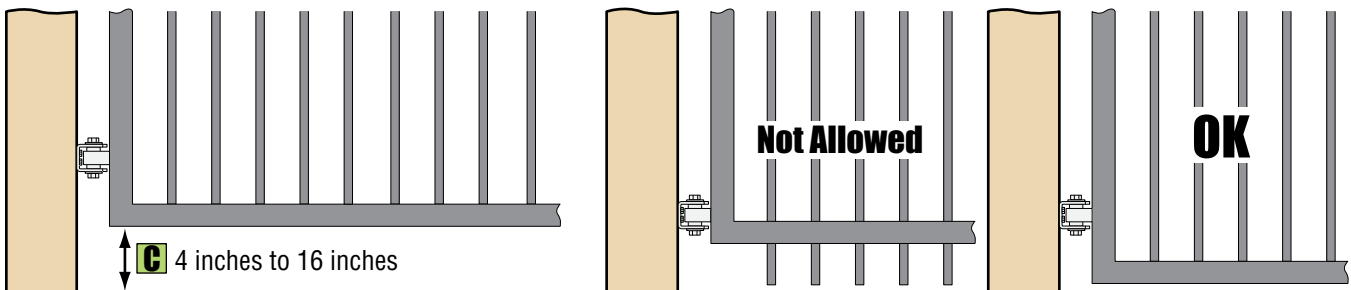

Gates shall have smooth bottom edges, with vertical bottom edged protrusions **NOT** exceeding 0.50 inches.

Swing Gate Requirements Continued

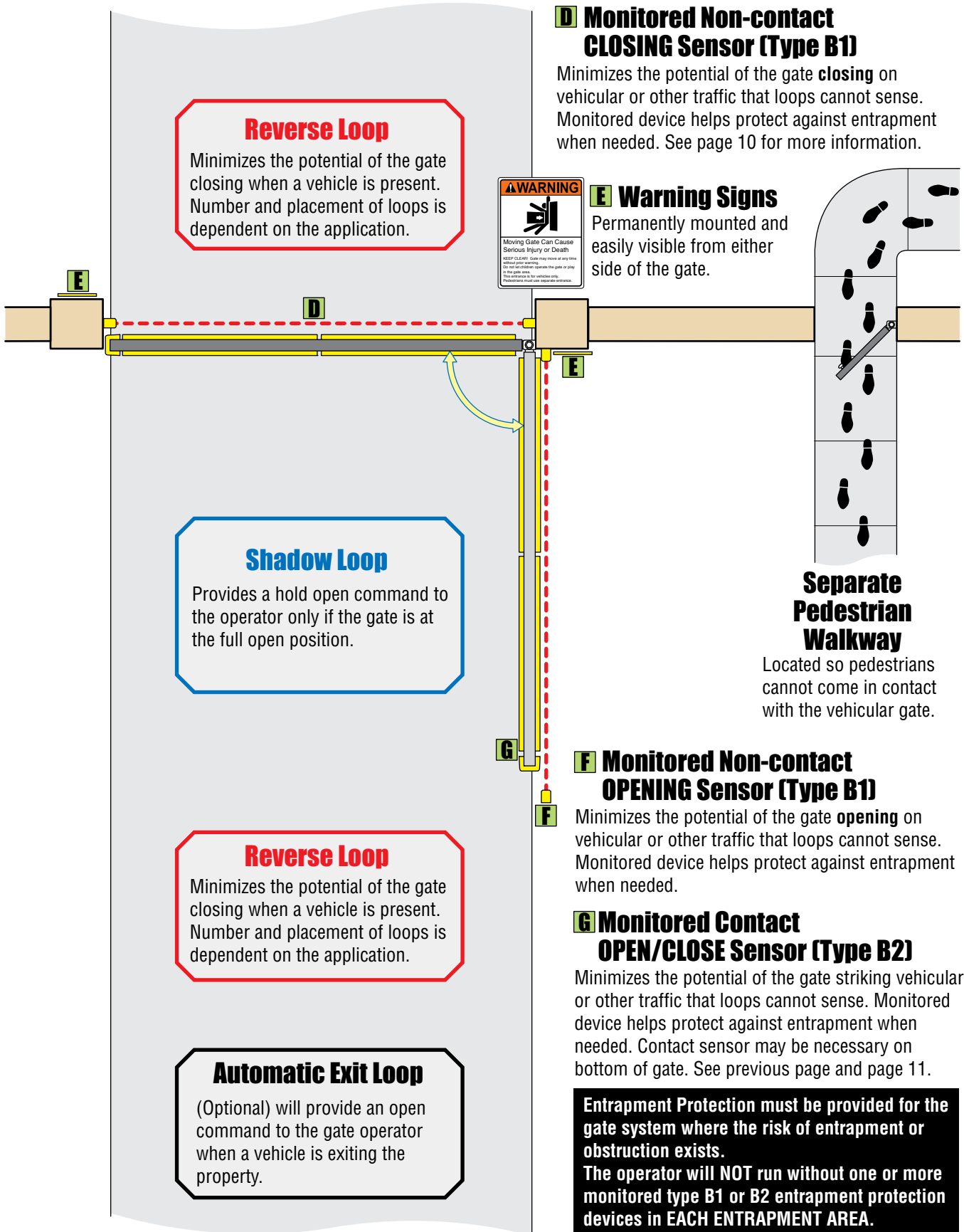

Reverse Loop
Minimizes the potential of the gate closing when a vehicle is present. Number and placement of loops is dependent on the application.

Shadow Loop
Provides a hold open command to the operator only if the gate is at the full open position.

Reverse Loop
Minimizes the potential of the gate closing when a vehicle is present. Number and placement of loops is dependent on the application.

Automatic Exit Loop
(Optional) will provide an open command to the gate operator when a vehicle is exiting the property.

D Monitored Non-contact CLOSING Sensor (Type B1)

Minimizes the potential of the gate **closing** on vehicular or other traffic that loops cannot sense. Monitored device helps protect against entrapment when needed. See page 10 for more information.

E Warning Signs

Permanently mounted and easily visible from either side of the gate.

Separate Pedestrian Walkway

Located so pedestrians cannot come in contact with the vehicular gate.

F Monitored Non-contact OPENING Sensor (Type B1)

Minimizes the potential of the gate **opening** on vehicular or other traffic that loops cannot sense. Monitored device helps protect against entrapment when needed.

G Monitored Contact OPEN/CLOSE Sensor (Type B2)

Minimizes the potential of the gate striking vehicular or other traffic that loops cannot sense. Monitored device helps protect against entrapment when needed. Contact sensor may be necessary on bottom of gate. See previous page and page 11.

Entrapment Protection must be provided for the gate system where the risk of entrapment or obstruction exists. The operator will NOT run without one or more monitored type B1 or B2 entrapment protection devices in EACH ENTRAPMENT AREA.

ASTM F2200 Standard for Gate Construction

Vehicular gates should be constructed and installed in accordance with ASTM F2200; Standard Specification for Automated Vehicular Gate Construction. For a copy of this standard, contact ASTM directly at 610-832-9585; service@astm.org; or www.astm.org.

Important Safety Instructions

WARNING - To reduce the risk of injury or death:

1. READ AND FOLLOW ALL INSTRUCTIONS.
2. Never let children operate or play with gate controls. Keep the remote control away from children.
3. Always keep people and objects away from gate. **NO ONE SHOULD CROSS THE PATH OF THE MOVING GATE.**
4. Test the operator monthly. The gate **MUST** reverse on contact with a rigid object or stop or reverse when an object activates the non-contact sensors. After adjusting the force or the limit of travel, retest the gate operator. Failure to adjust and retest the gate operator properly can increase the risk of injury or death.
5. Use the emergency release only when the gate is not moving.
6. **KEEP GATES PROPERLY MAINTAINED.** Read the owner's manual. Have a qualified service person make repairs to gate hardware.
7. The entrance is for vehicles only. Pedestrians must use separate entrance.
8. **SAVE THESE INSTRUCTIONS!**

Instructions regarding intended installation:

- Install the gate operator only if:
 1. The operator is appropriate for the construction of the gate and the usage class of the gate.
 2. All openings of a horizontal slide gate are guarded or screened from the bottom of the gate to a minimum of 6 feet (1.83 m) above the ground to prevent a 2 ¼ inch (57.2 mm) diameter sphere from passing through the openings anywhere in the gate, and in that portion of the adjacent fence that the gate covers in the open position.
 3. All exposed pinch points are eliminated or guarded.
 4. Guarding is supplied for exposed rollers.
- The operator is intended for installation only on gates used for vehicles. Pedestrians must be supplied with a separate access opening. The pedestrian access opening shall be designed to promote pedestrian usage. Locate the gate such that persons will not come in contact with the vehicular gate during the entire path of travel of the vehicular gate.
- The gate must be installed in a location so that enough clearance is supplied between the gate and adjacent structures when opening and closing to reduce the risk of entrapment. Swinging gates should not open into public access areas.
- The gate must be properly installed and work freely in both directions prior to the installation of the gate operator. Do not over-tighten the operator clutch, pressure relief valve or reduce reversing sensitivity to compensate for a damaged gate.
- For gate operators utilizing Type D protection:
 1. The gate operator controls must be placed so that the user has full view of the gate area when the gate is moving.
 2. A warning placard shall be placed adjacent to the controls.
 3. An automatic closing device (such as a timer, loop sensor, or similar device) shall not be employed.
 4. No other activation device shall be connected.
- Controls intended for user activation must be located at least six feet (6') away from any moving part of the gate and where the user is prevented from reaching over, under, around or through the gate to operate the controls. Outdoor or easily accessible controls should have a security feature to prevent unauthorized use.
- The Stop and/or Reset button must be located in the line-of-sight of the gate. Activation of the reset control shall not cause the operator to start.
- A minimum of two (2) **WARNING SIGNS** shall be installed, one on each side of the gate where easily visible.
- For gate operators utilizing a non-contact sensor:
 1. See the instructions on the placement of non-contact sensors for each type of application.
 2. Care shall be exercised to reduce the risk of nuisance tripping, such as when a vehicle trips the sensor while the gate is still moving in the opening direction.
 3. One or more non-contact sensors shall be located where the risk of entrapment or obstruction exist, such as the perimeter reachable by a moving gate or barrier.
- For gate operators utilizing contact sensors:
 1. One or more contact sensors shall be located where the risk of entrapment or obstruction exist, such as at the leading edge, trailing edge, and post mounted both inside and outside of a vehicular horizontal slide gate.
 2. One or more contact sensors shall be located at the bottom edge of a vehicular vertical lift gate.
 3. One or more contact sensors shall be located at the pinch point of a vehicular vertical pivot gate.
 4. A hardwired contact sensor shall be located and its wiring arranged so that the communication between the sensor and the gate operator is not subjected to mechanical damage.
 5. A wireless contact sensor such as one that transmits radio frequency (RF) signals to the gate operator for entrapment protection functions shall be located where the transmission of the signals are not obstructed or impeded by building structures, natural landscaping or similar obstructions. A wireless contact sensor shall function under the intended end-use conditions.
 6. One or more contact sensors shall be located at the bottom edge of a vertical barrier (arm).
- Be sure you have instructed the owner of the gate operator about safe and proper operation and testing of the gate operator.

Important Notices

Vehicular gate operator products provide convenience and security. However, gate operators must use high levels of force to move gates and most people underestimate the power of these systems and do not realize the potential hazards associated with an incorrectly designed or installed system. These hazards may include:

- Pinch points
- Entrapment areas
- Reach through hazards
- Absence of entrapment protection devices
- Improperly located access controls
- Absence of vehicle protection devices
- Absence of controlled pedestrian access

In addition to these potential hazards, automated vehicular gate systems must be installed in accordance with the UL 325 Safety Standard and the ASTM F2200 Construction Standard. Most people are unaware of, or are not familiar with, these standards. If an automated vehicular gate system is not properly designed, installed, used and maintained, serious injuries or death can result. Be sure that the installer has instructed you on the proper operation of the gate and gate operator system.

Be sure that the installer has trained you on proper and safe operation of this gate operating system and about the basic functions of the required reversing systems associated with your gate operating system and how to test them. These include reversing loops, inherent reversing system, electric edges, photoelectric cells, or other external devices.

- This Owner's Manual is your property. Keep it in a safe place for future reference.
- Be sure that all access control devices are installed a minimum distance of 6 feet away from the gate and gate operator, or in such a way that a person cannot touch the gate or gate operator while using the device. If access control devices are installed in violation of these restrictions, immediately remove the gate operator from service and contact your installing dealer.

Opening device MUST be mounted a minimum of 6 feet from the gate and NOT accessible through the gate!



- Loops and loop detectors, photo-cells or other equivalent devices must be installed to prevent the gate from closing on vehicular traffic.
- The speed limit for vehicular traffic through the gate area is 5 MPH. Install speed bumps and signs to keep vehicular traffic from speeding through the gate area. Failure to adhere to posted speed limits can result in damage to the gate, gate operator, and to the vehicle.
- Be sure that all persons who will use the gate system are familiar with the proper use of the gate and gate operator and are familiar with the possible hazards associated with the gate system.
- Be sure that warning signs are permanently installed on both sides of the gate in an area where they are fully visible to traffic.
- It is your responsibility to periodically check all entrapment protection devices. If any of these devices are observed to function improperly, remove the operator from service immediately and contact your installing or servicing dealer.
- Follow the recommended maintenance schedule.
- Do not allow children to play in the area of the operator or to play with any gate-operating device.
- To remove the gate operator from service, operate the gate to the full open position and then shut off power to the operator at the service panel.

UL 325 Entrapment Protection

UL 325 Classifications

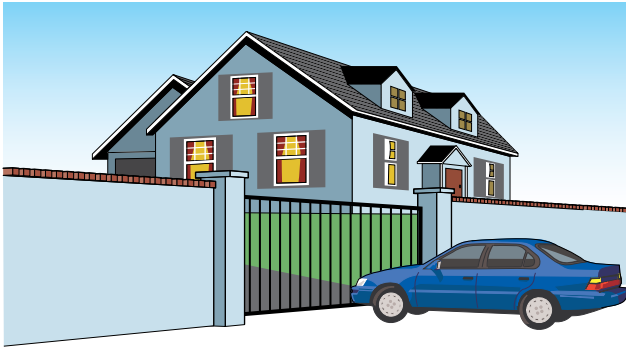

Class I - Residential Vehicular Gate Operator

A vehicular gate operator (or system) intended for use in garages or parking areas associated with a residence of one-to four single families.

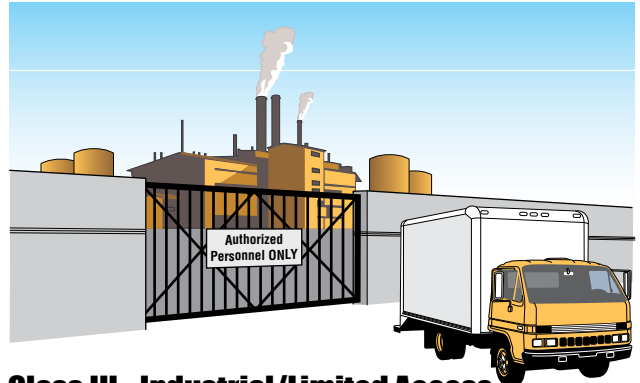

Class III - Industrial/Limited Access Vehicular Gate Operator

A vehicular gate operator (or system) intended for use in an industrial location or building such as a factory or loading dock area or other locations not accessible by or intended to service the general public.

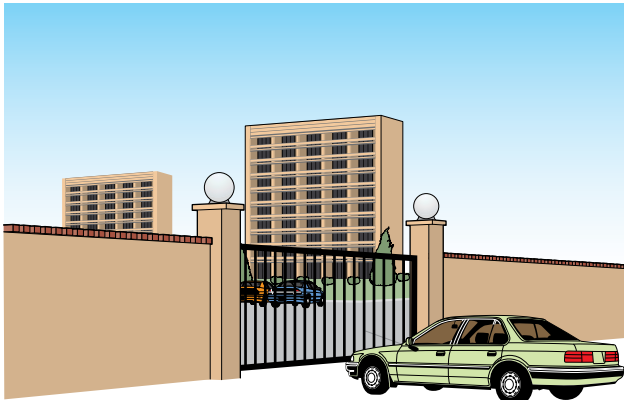

Class II - Commercial/General Access Vehicular Gate Operator

A vehicular gate operator (or system) intended for use in a commercial location or building such as a multi-family housing unit (five or more single family units), hotel, garages, retail store, or other buildings accessible by or servicing the general public.



Class IV - Restricted Access Vehicular Gate Operator

A vehicular gate operator (or system) intended for use in a guarded industrial location or building such as an airport security area or other restricted access locations not servicing the general public, in which unauthorized access is prevented via supervision by security personnel.

Gate Operator Category

Effective January 12, 2016	Horizontal Slide, Vertical Lift, Vertical Pivot	Swing, Vertical Barrier (Arm)
Entrapment Protection Types	A, B1*, B2* or D	A, B1*, B2*, C or D

- Type A** - Inherent entrapment protection system.
- Type B1** - Non-contact sensor (photoelectric sensor or the equivalent).
- Type B2** - Contact sensor (edge device or equivalent).
- Type C** - Inherent force limiting, inherent adjustable clutch or inherent pressure relief device.
- Type D** - Actuating device requiring constant pressure to maintain opening or closing motion of the gate.

* B1 and B2 means of entrapment protection must be MONITORED.

Vertical Barrier Note: Barrier gate operators (arm) that is not intended to move toward a rigid object closer than 16 inches (406 mm) are not required to be provided with a means of entrapment protection.

Glossary

GATE - A moving barrier such as a swinging, sliding, raising, lowering, or the like, barrier, that is a stand-alone passage barrier or is that portion of a wall or fence system that controls entrance and/or egress by persons or vehicles and completes the perimeter of a defined area.

RESIDENTIAL VEHICULAR GATE OPERATOR – CLASS I - A vehicular gate operator (or system) intended for use in a home of one-to four single family dwelling, or garage or parking area associated therewith.

COMMERCIAL / GENERAL ACCESS VEHICULAR GATE OPERATOR - CLASS II - A vehicular gate operator (or system) intended for use in a commercial location or building such as a multi-family housing unit (five or more single family units), hotels, garages, retail store, or other building servicing the general public.

INDUSTRIAL / LIMITED ACCESS VEHICULAR GATE OPERATOR - CLASS III - A vehicular gate operator (or system) intended for use in an industrial location or building such as a factory or loading dock area or other locations not intended to service the general public.

RESTRICTED ACCESS VEHICULAR GATE OPERATOR - CLASS IV - A vehicular gate operator (or system) intended for use in a guarded industrial location or building such as an airport security area or other restricted access locations not servicing the general public, in which unauthorized access is prevented via supervision by security personnel.

VEHICULAR BARRIER (ARM) OPERATOR (OR SYSTEM) - An operator (or system) that controls a cantilever type device (or system), consisting of a mechanical arm or barrier that moves in a vertical arc, intended for vehicular traffic flow at entrances or exits to areas such as parking garages, lots or toll areas.

VEHICULAR HORIZONTAL SLIDE-GATE OPERATOR (OR SYSTEM) - A vehicular gate operator (or system) that controls a gate which slides in a horizontal direction that is intended for use for vehicular entrance and exit to a drive, parking lot, or the like.

VEHICULAR SWING-GATE OPERATOR (OR SYSTEM) - A vehicular gate operator (or system) that controls a gate which moves in an arc in a horizontal plane that is intended for use for vehicular entrance and exit to a drive, parking lot, or the like.

SYSTEM - In the context of these requirements, a system refers to a group of interacting devices intended to perform a common function.

WIRED CONTROL - A control implemented in a form of fixed physical interconnections between the control, the associated devices, and an operator to perform predetermined functions in response to input signals.

WIRELESS CONTROL - A control implemented in means other than fixed physical interconnections (such as radio waves or infrared beams) between the control, the associated devices, and an operator to perform predetermined functions in response to input signals.

INHERENT ENTRAPMENT PROTECTION SYSTEM - A system, examples being a motor current or speed sensing system, which provides protection against entrapment upon sensing an object and is incorporated as a permanent and integral part of the operator.

EXTERNAL ENTRAPMENT PROTECTION DEVICE - A device, examples being an edge sensor, a photoelectric sensor, or similar entrapment protection device, which provides protection against entrapment when activated and is not incorporated as a permanent part of an operator.

ENTRAPMENT - The condition when an object is caught or held in a position that increases the risk of injury.

SECTION 1 - WIRING

Before attempting to connect any wiring to the control box, be sure that the circuit breaker in the electrical panel is in the OFF position. Permanent wiring must be installed to the control box as required by local electrical codes. It is recommended that a licensed electrical contractor perform this work.

Since building codes vary from city to city, we highly recommend that you check with your local building department prior to installing any permanent wiring to be sure that all wiring to the control box (both high and low voltage) complies with local code requirements.

THIS CONTROL BOX MUST BE PROPERLY GROUNDED!!

1.1 Control Box Wiring Overview

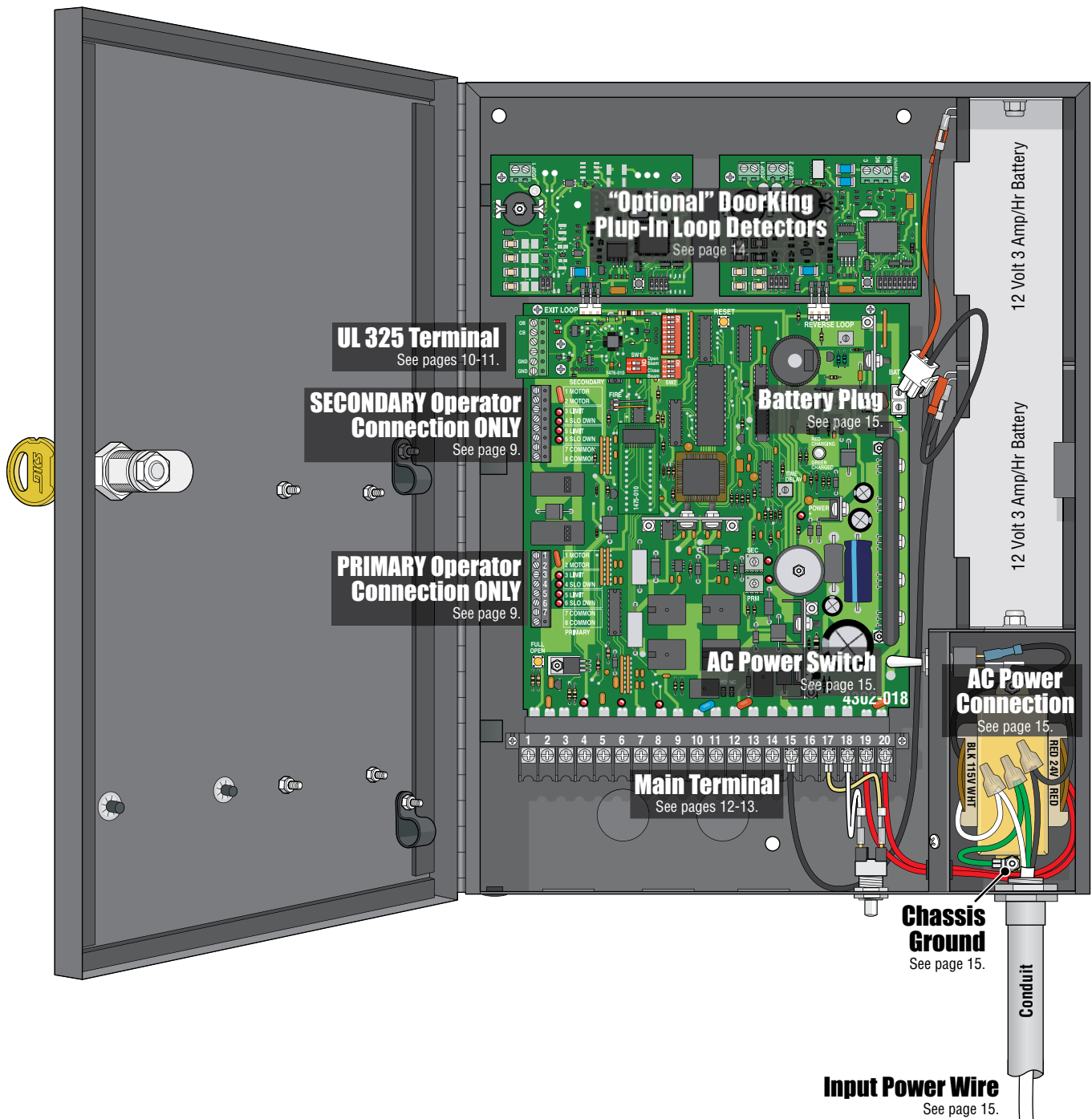

1.2 Wiring Operators to 4302-018 Circuit Board

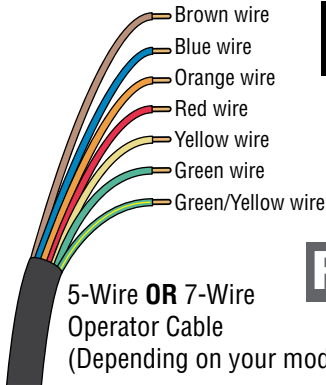

IMPORTANT: External entrapment protection **MUST** be installed or the operator will **NOT** function.

Secondary Operator ONLY

DO NOT connect primary/single operator to this terminal.

Primary/Single Operator ONLY

DO NOT connect secondary operator to this terminal.

DO NOT cycle the operator **BEFORE** setting limit sensors.

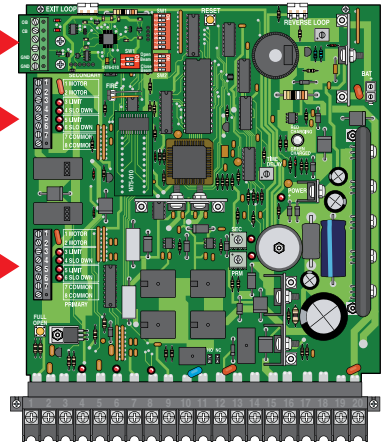

Choose Your Operator Model: Follow wiring colors for the PRIMARY/Single or DUAL gate operators.

6003 Wiring

6004 Wiring

7-Wire Operator Cable

Factory wired jumpers **MUST** be removed.

Primary/Single operator wiring

1	1 MOTOR
2	2 MOTOR
3	3 LIMIT
4	4 SLO DWN
5	5 LIMIT
6	6 SLO DWN
7	7 COMMON
8	8 COMMON

PRIMARY

Secondary operator wiring

1	1 MOTOR
2	2 MOTOR
3	3 LIMIT
4	4 SLO DWN
5	5 LIMIT
6	6 SLO DWN
7	7 COMMON
8	8 COMMON

SECONDARY

6005 Wiring

5-Wire Operator Cable

Note: RED and GREEN wires from operator cable are not used.

Factory wired jumpers **MUST** remain connected as shown. SLO DWN LEDs are always lit.

6005 Primary/Single operator wiring

1	1 MOTOR
2	2 MOTOR
3	3 LIMIT
4	4 SLO DWN
5	5 LIMIT
6	6 SLO DWN
7	7 COMMON
8	8 COMMON

PRIMARY

6005 Secondary operator wiring

1	1 MOTOR
2	2 MOTOR
3	3 LIMIT
4	4 SLO DWN
5	5 LIMIT
6	6 SLO DWN
7	7 COMMON
8	8 COMMON

SECONDARY

6400 Wiring

7-Wire Operator Cable

Note: Secondary operator MOTOR wires **MUST** be reversed from the primary operator when using DUAL gate operators.

Factory wired jumpers **MUST** be removed.

6400 Primary/Single operator wiring

1	1 MOTOR
2	2 MOTOR
3	3 LIMIT
4	4 SLO DWN
5	5 LIMIT
6	6 SLO DWN
7	7 COMMON
8	8 COMMON

PRIMARY

6400 Secondary operator wiring

1	1 MOTOR
2	2 MOTOR
3	3 LIMIT
4	4 SLO DWN
5	5 LIMIT
6	6 SLO DWN
7	7 COMMON
8	8 COMMON

SECONDARY

1.3 Entrapment Protection Wiring

External Entrapment Protection Devices:

In addition to the inherent reversing sensor system, this operator has a UL 325 terminal for the connection of **photo sensors-Type B1 and/or reversing edges-Type B2** entrapment protection required by UL 325 standards. **Entrapment Protection must be provided for the gate system where the risk of entrapment or obstruction exists. The operator will NOT run without one or more monitored type B1 or B2 external entrapment protection devices installed in each entrapment area.** Install these devices where the risk of entrapment or a safety hazard exists. Installations can vary.

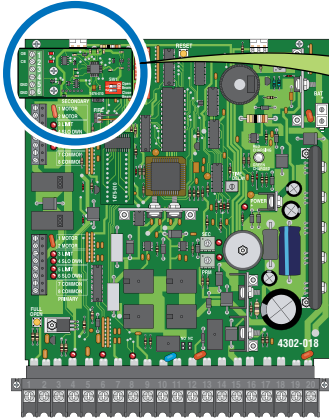

Type of wiring to be used on ALL external devices:
A) Type CL2, CL2P, CL2R, or CL2X.
B) Other cable with equivalent or better electrical, mechanical, and flammability ratings.

UL 325 Terminal

Note: Only 1 monitored Device can be connected to each input. An **OPTIONAL** Expansion Kit (sold separately) will allow connection for additional devices.

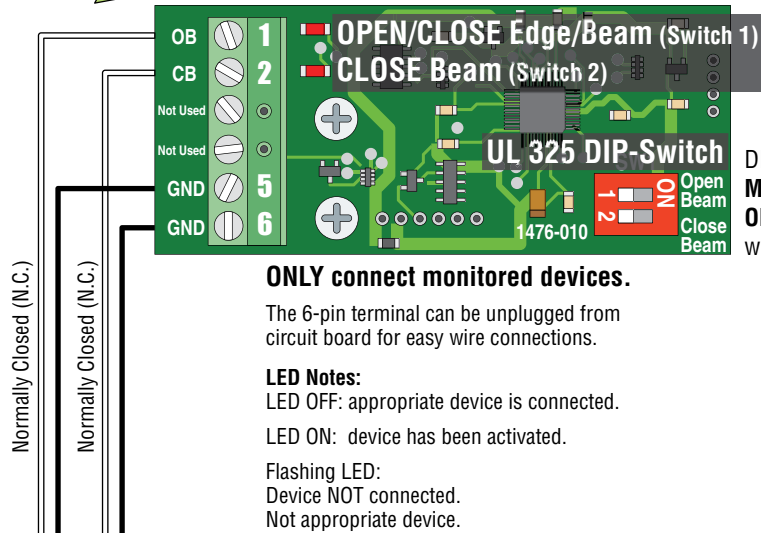

DIP-switches **MUST** be turned **ON** for each device wired to terminal.

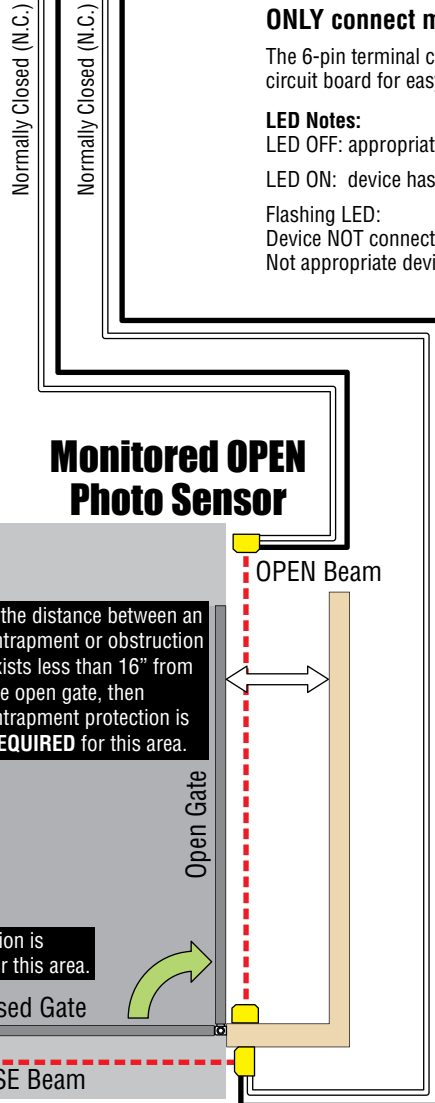

OPEN/CLOSE Edge/Beam UL 325 DIP-Switch 1 ON:
OPENING: Obstructed open-direction device will **Reverse** the gate to the CLOSE position.

CLOSE Beam UL 325 DIP-Switch 2 ON:
CLOSING: Obstructed closing-direction photo beam will **REVERSE** the gate to the open position and reset timer when ON.

Note: If obstruction occurs again during the closing-direction, Gate will reverse back to open position and enter a soft shutdown.

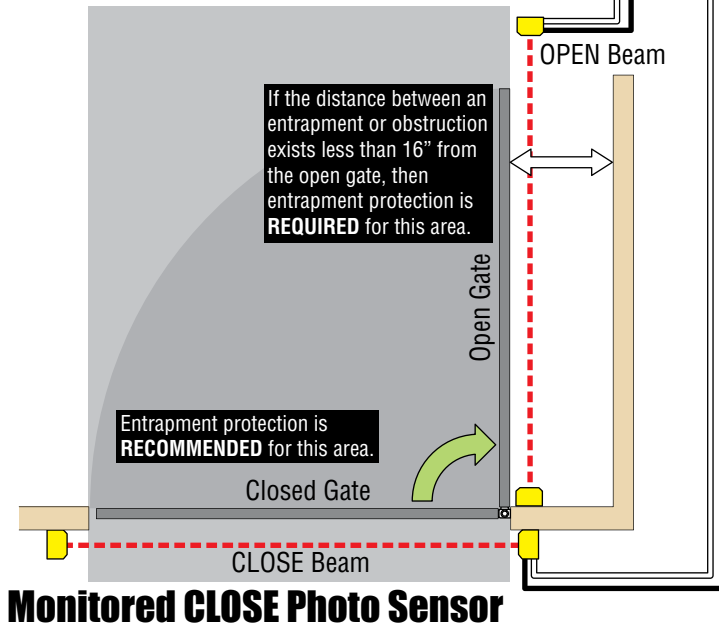

IMPORTANT: Photo sensors must use **Normally Closed (NC)** contacts with the beam set for light operate (relay activated when beam is not obstructed). Some manufacturer's photo sensor contacts are labeled as **Normally Open (NO)** but their relay functions the same way as described above. See specific manufacturer's wiring manual for more information about their specific relay function.

1.3 Entrapment Protection Wiring Continued

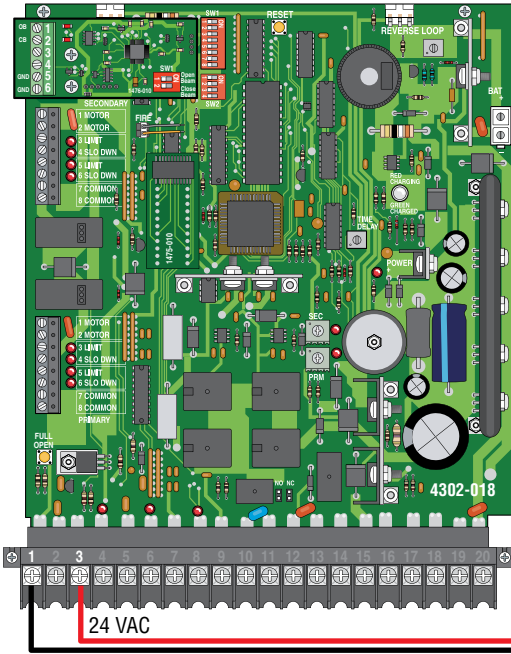

Main Terminal #3 Note:
Exceeding the mA of power from this terminal may cause the circuit board transformer to overheat, causing intermittent problems.

OPTIONAL Wireless Note: Refer to the instruction sheet that comes with the receiver/transmitter for more specific wiring and mounting instructions.

Receiver **MUST** monitor for the presence of the transmitter.

Type of wiring to be used on ALL external devices:
A) Type CL2, CL2P, CL2R, or CL2X.
B) Other cable with equivalent or better electrical, mechanical, and flammability ratings.

WIRELESS Multiple Reversing Edge Configuration

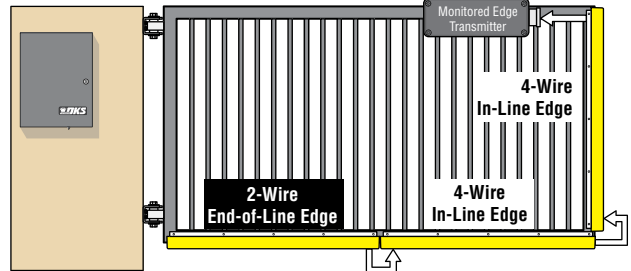

HARDWIRED Multiple Reversing Edge Configuration

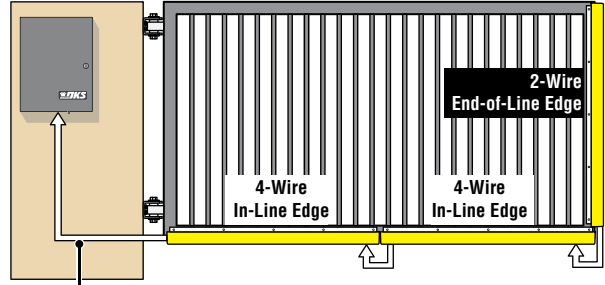

Wiring to Control Box
Hardwiring arranged so that the communication between the sensor and the gate operator is **NOT** subjected to mechanical damage.

Wiring Multiple Reversing Edges
(Add as many "4-wire" In-Line edges as needed)
Reversing Edges are wired in series

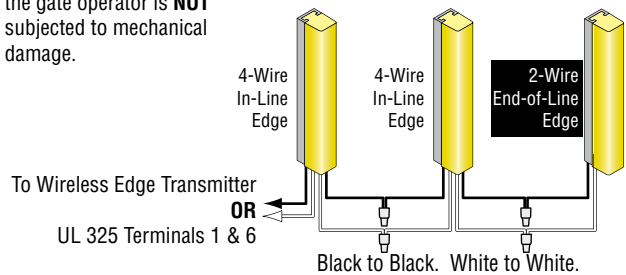

UL 325 Terminal

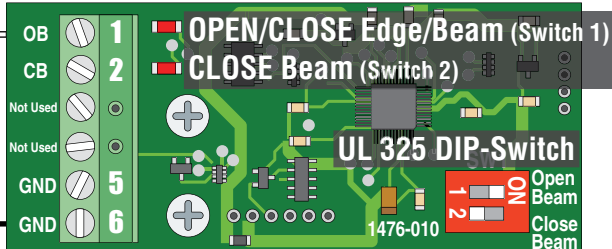

Note: Only 1 monitored Device can be connected to each input. An **OPTIONAL** Expansion Kit (sold separately) will allow connection for additional devices.

ONLY connect monitored devices.

The 6-pin terminal can be unplugged from circuit board for easy wire connections.

LED Notes:

LED OFF: appropriate device is connected.

LED ON: device has been activated.

Flashing LED: Device NOT connected.
Not appropriate device.

Entrapment Protection must be provided for the gate system where the risk of entrapment or obstruction exists. The operator will not run without one or more monitored type B1 or B2 entrapment protection devices in EACH entrapment area.

Monitored OPEN/CLOSE Reversing Edge

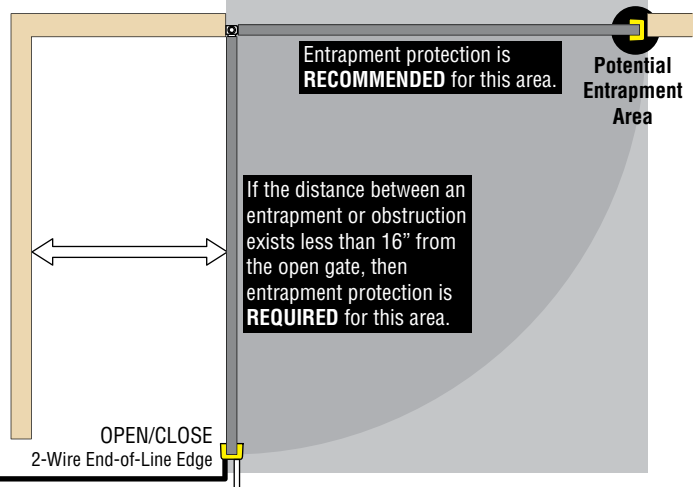

Normally Closed (N.C.)

1.4 Main Terminal Description

For specific wiring information, see next page.

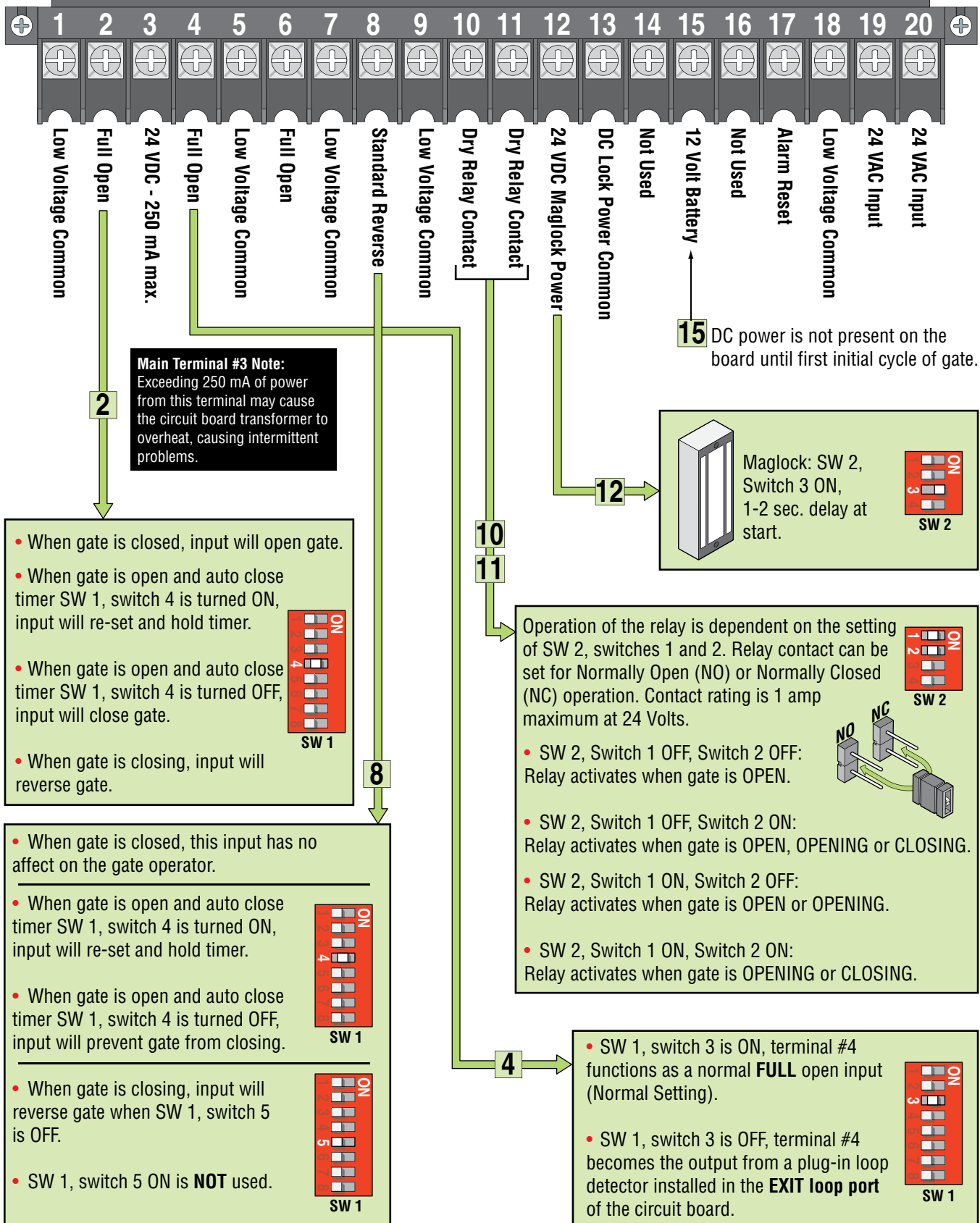

1.5 Main Terminal Wiring

Controls intended for user activation must be located at least six (6) feet away from any moving part of the gate and where the user is prevented from reaching over, under, around or through the gate to operate the controls. Emergency access controls only accessible by authorized personnel (e.g., fire, police, EMS) may be placed at any location in the line-of-sight of the gate. When installing electrical equipment make certain all wiring complies with local code requirements. Do not power any control devices from the circuit board other than low voltage devices.

For individual terminal descriptions, see previous page.

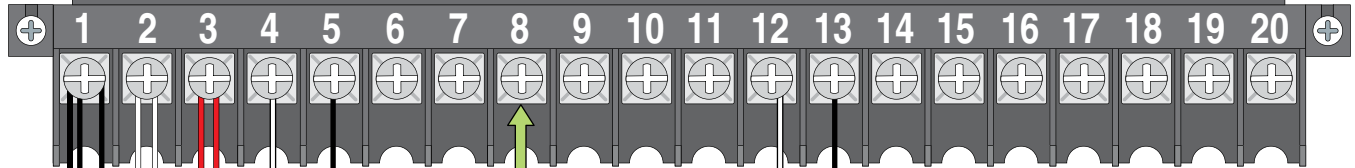

Type of wiring to be used on ALL external devices:
A) Type CL2, CL2P, CL2R, or CL2X.
B) Other cable with equivalent or better electrical, mechanical, and flammability ratings.

Reversing input on Terminal #8 functions **ONLY** while the gate is at the **FULL OPEN** position or during the **CLOSING** cycle. It **MUST NOT** be used as an input for entrapment protection device during the **OPENING** gate cycle. Refer to Section 1.3 Entrapment Protection Wiring.

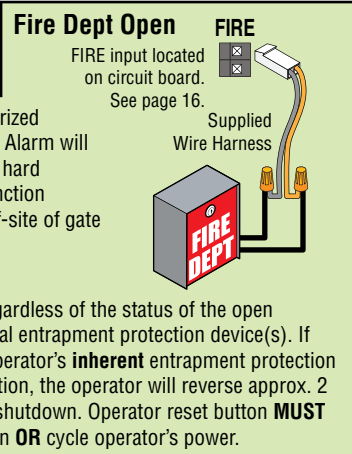
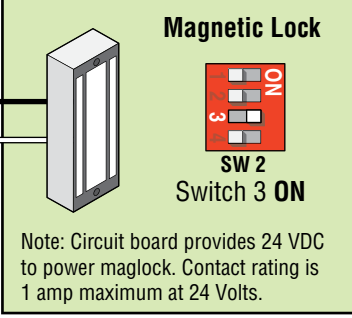

Connect optional control devices to the main terminal. Use 18 AWG wire for all low voltage wiring, maximum distance 3000 feet. Use a low voltage surge suppressor, (DoorKing P/N 1878-010) if low voltage wire runs exceed 1000 feet. All control device inputs to the terminal must be **NORMALLY OPEN**.

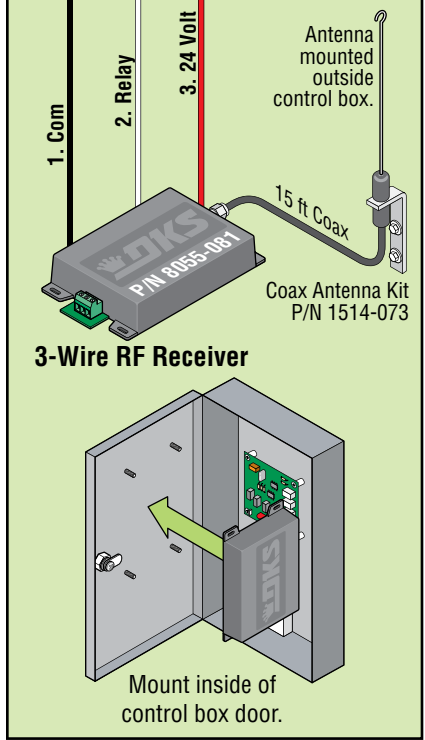

Main Terminal #3 Note:
 Exceeding 250 mA of power from this terminal may cause the circuit board transformer to overheat, causing intermittent problems.

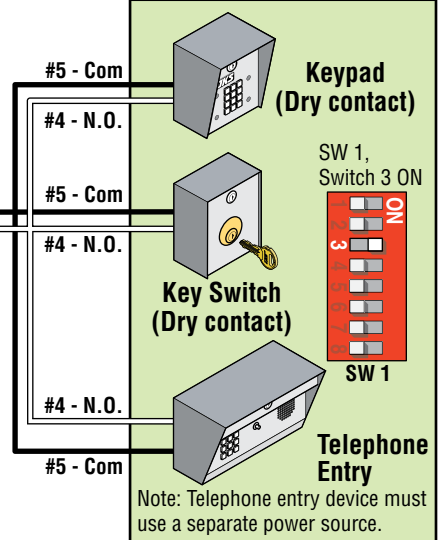
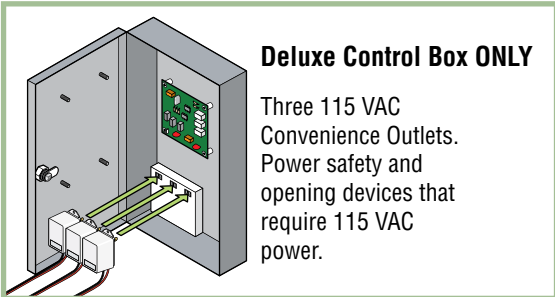

1.6 Loop Detector Wiring

To help protect the operator from accidentally closing on vehicles in the gate's path, DoorKing highly recommends that loops and loop detectors are used. A loop detection system will sense a vehicle like a metal detector and send a signal to the gate operator preventing the gate from automatically opening or closing on a vehicle when it is in the gate's path. DoorKing recommends that a licensed installer perform this work.

Shadow Loop The shadow loop is **only active when the gate is in the full open position**. Vehicles in the shadow area will activate it. It will not allow the gate to close unless this area is clear. After a closing cycle begins, the shadow loop **will not** reverse the gate. Reverse loops work in conjunction with the shadow loop and both type loops should be used.

DoorKing offers a free **"Loop and Loop-Detectors Information Manual"** PDF located at DoorKing's web site for more information. www.doorking.com

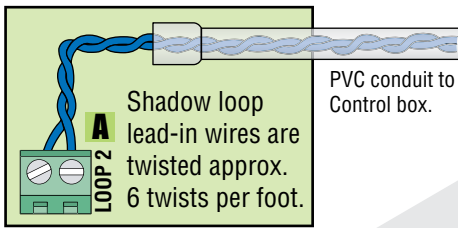
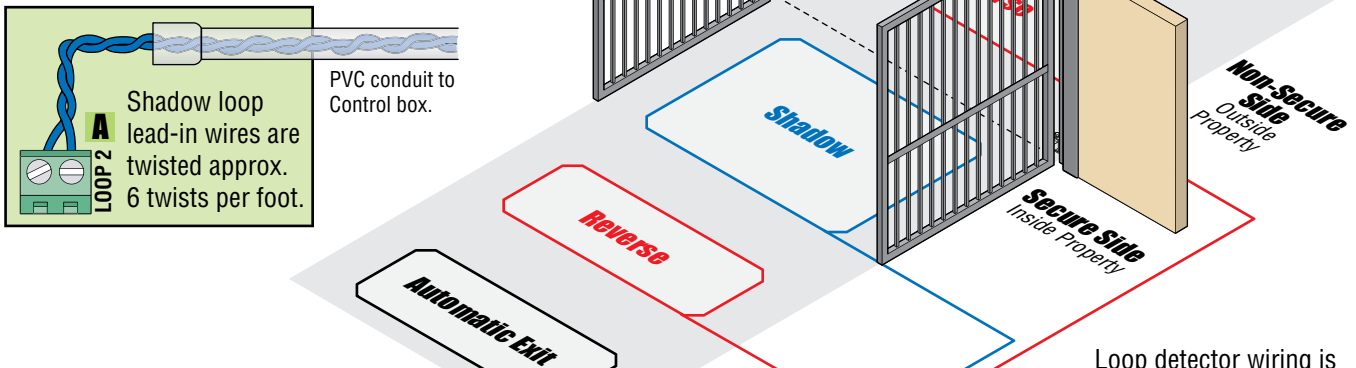

Reverse Loops

Reverse loops prevent the gate from closing on a vehicle in or near the gate's swing pathway.

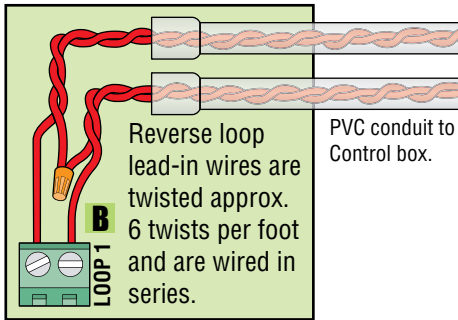

Automatic Exit Loop

Automatically opens the gate for exiting vehicles without having to use a transmitter or keypad (Free exit).

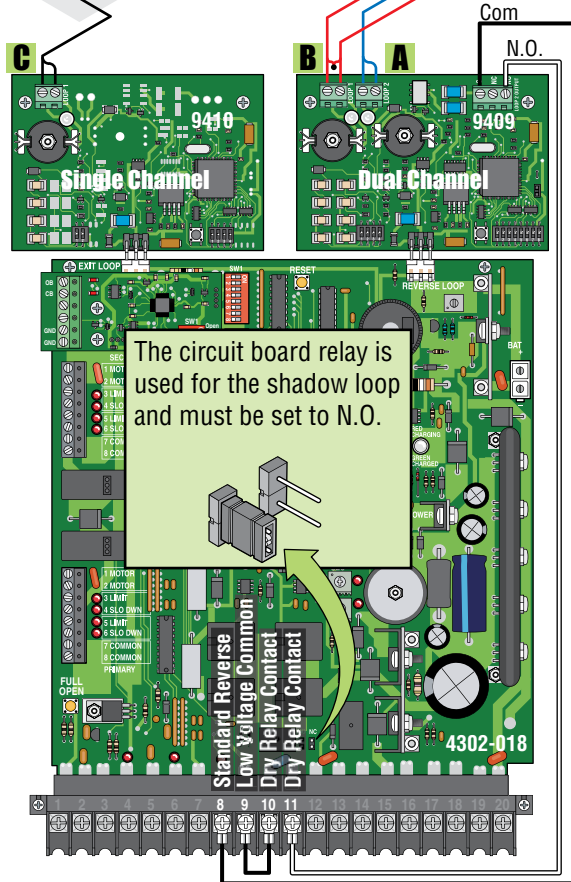
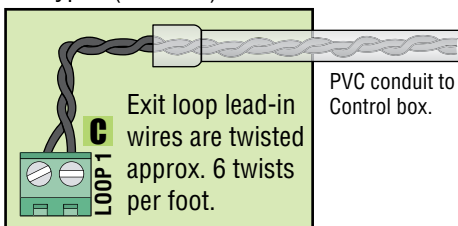

Loop detector wiring is shown for DoorKing plug-in loop detectors P/N 9409-010 and P/N 9410-010 only. If other loop detectors are used, refer to the installation instructions supplied with those detectors for wiring and separate power instructions.

Shadow Loop Output

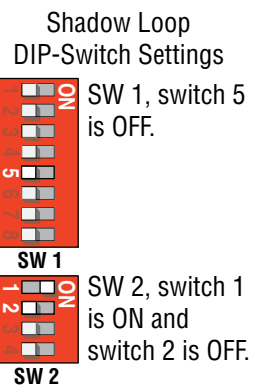

1.7 High Voltage Wiring and Battery Connection

CONTROL BOX MUST BE PROPERLY GROUNDED!!

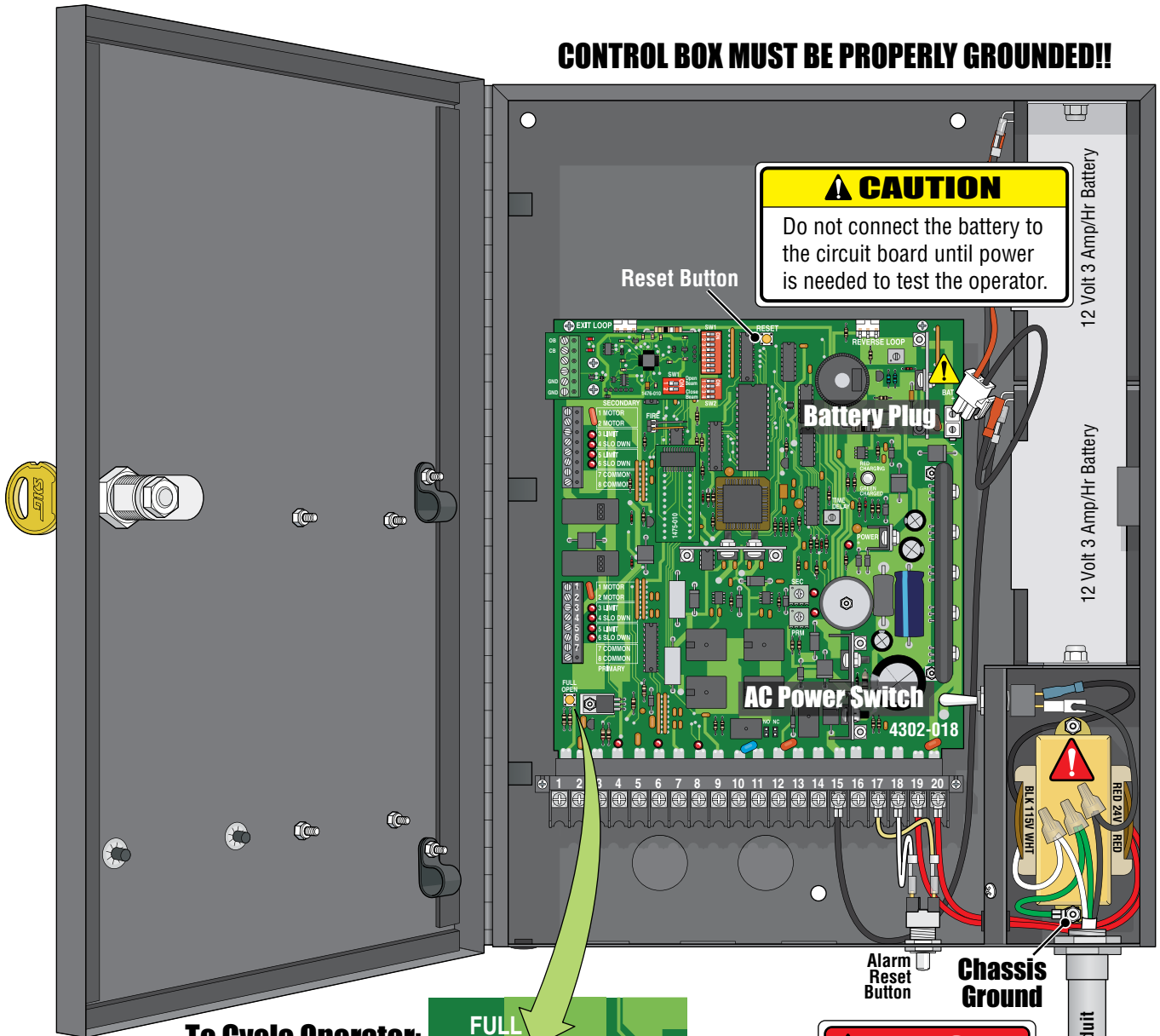

CAUTION
Do not connect the battery to the circuit board until power is needed to test the operator.

To Cycle Operator:

After power has been connected, activate the operator by pressing the full open button. **DO NOT cycle operator before DIP-switches and limit sensors have been adjusted, damage could occur to gate and operator** (See pages 17-22 to adjust DIP-switches and limit sensors).

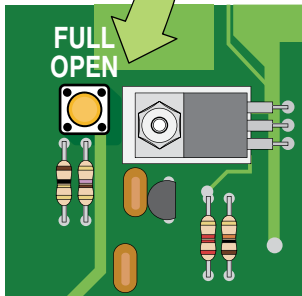

DANGER HIGH VOLTAGE!

Connect 115 VAC input power wires:
Black to transformer's black (Hot).
White to transformer's white (Neutral).
Green to chassis ground.

An **EXTERNAL ENTRAPMENT PROTECTION DEVICE** MUST be connected or the gate operator **WILL NOT** function.

Important Power Note: To turn-off **ALL** power to the operator, the AC power switch must be turned off **AND** the battery plug must be disconnected from the circuit board.

Input Power Wire Table

Wire Size	Distance
14 AWG	Up to 200 ft
12 AWG	Beyond 200 ft

DoorKing recommends that a surge suppressor be installed on the high voltage power lines.
P/N 1879-080

External Power Disconnect Switch

Note: A separate power disconnect switch may be needed in your area. Check local building codes before installation.

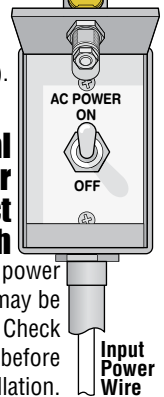

SECTION 2 - ADJUSTMENTS

The switch settings and adjustments in this section should be made after your installation and wiring to the operator(s) is complete. **Whenever any programming or switch setting on the control board are changed, press the reset button for new settings to take effect.**

2.1 4302 Circuit Board Description and Adjustments

Plug-In Loop Detector
9410 Single Channel

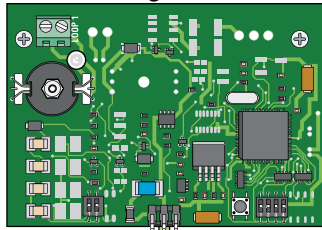

Plug-In Loop Detector
9409 Dual Channel

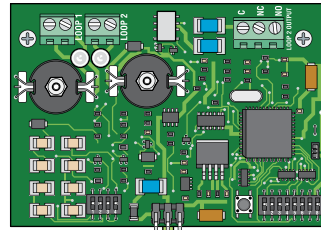

See page 14.

UL 325 Terminal
See pages 10-11.

Exit Loop Port

Reverse Loop Port

How LEDs Function



Illuminated LEDs
Indicates that low voltage power is being applied to the circuit board.

Input LEDs should be OFF and will only illuminate when the input wired to the corresponding main terminal is activated.

Limit LEDs will only illuminate when the respective limit sensor has been activated.

DIP-Switches

Set DIP-switches on the circuit board to the desired setting. See switch-setting charts on next 2 pages.

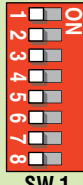

SW 1

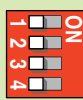

SW 2

FIRE Dept Open

Connect **ONLY** emergency access controls accessible by authorized personnel (e.g., fire, police, EMS). Upon activation, alarm will sound and the operator will go into a hard shutdown after reaching the open limit. Operator must be reset to resume normal operation. See pages 13 and 25.

SECONDARY Operator
See page 9.

PRIMARY Operator
See page 9.

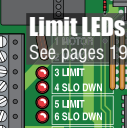
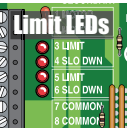

RESET



Press reset button to activate changed control board settings. Turns OFF activated alarm.

Auto-Close Timer

- Auto-close timer (when turned ON) SW 1, switch 4.

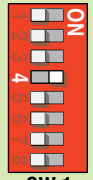

SW 1

Adjust from 1 second (full counter clockwise) to approximately 23 seconds (full clockwise).



FULL OPEN



Cycles the operator when pressed. Will use Auto-Close timer when turned ON.

Dry Relay Contact

Dry relay contacts (terminals 10-11) can be set for Normally Open (NO) or Normally Closed (NC) operation by placing the relay shorting bar on the N.O. or N.C. pins respectively. (Shadow loop function if used, N.O., see page 14).

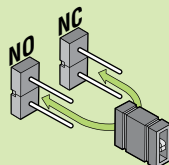

Turns alarm OFF.
See page 25 & 30.

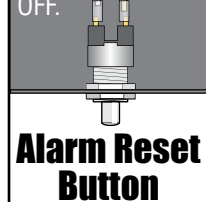

Alarm Reset Button

Inherent Reverse Sensors

Adjust reversing sensitivity for: PRIMARY (single) and SECONDARY (dual) operators. See page 23.

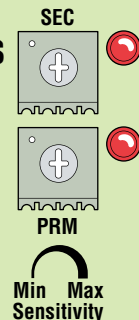

Min Max Sensitivity

2.2 DIP-Switches

Whenever any programming or switch setting on the control board is changed, press the reset button for new settings to take effect.

SW 1 (Top 8 Switches) Definitions on next page

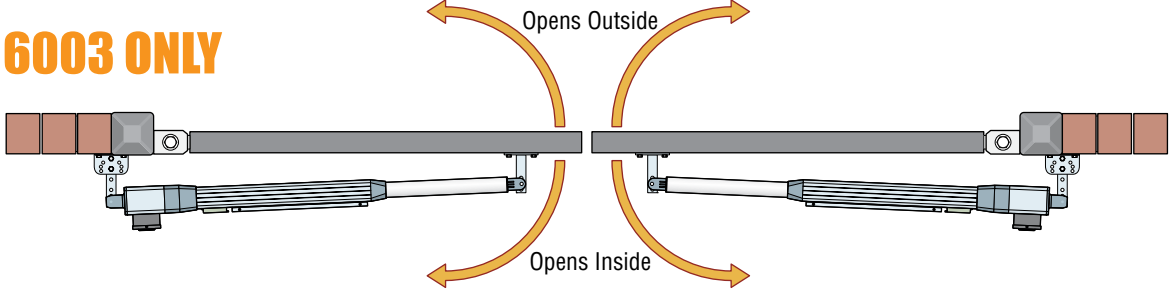
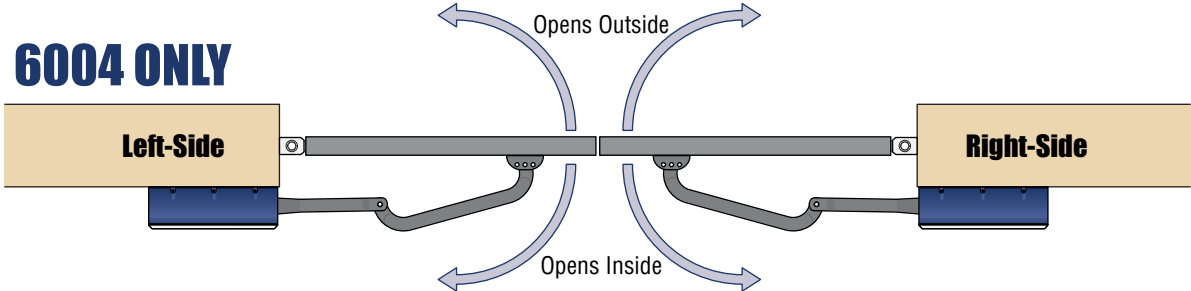
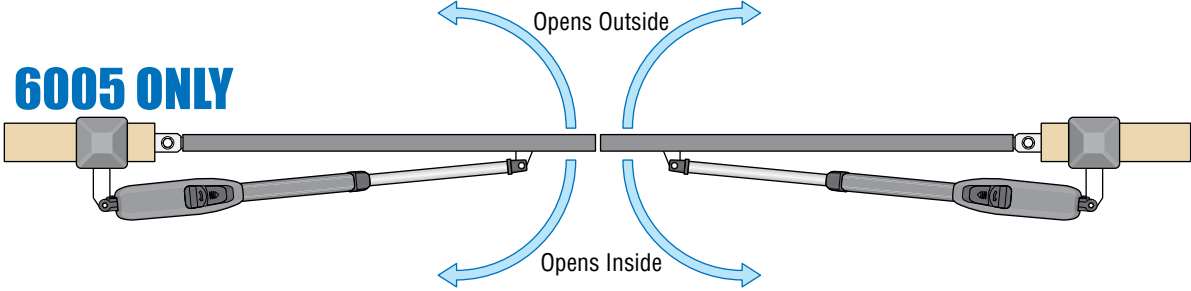
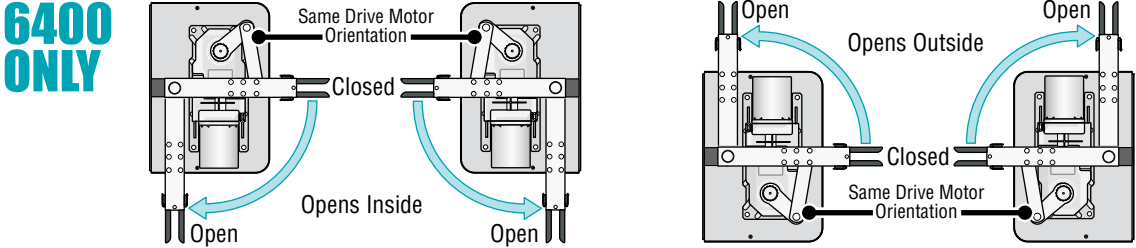
Switch	Function	Setting	Description
1			<p>Opening Direction of PRIMARY Operator</p> <p>The operator MUST OPEN GATE upon initial power up and OPEN command. If the operator closes gate after giving open command, shut off power and reverse this switch setting otherwise operator will NOT function correctly.</p> <p>6003 ONLY</p>  <p>6004 ONLY</p>  <p>6005 ONLY</p>  <p>6400 ONLY</p> 
	Opening Direction of SECONDARY Operator		<p>Same opening directions as illustrated above for the primary operator type.</p> <ul style="list-style-type: none"> Switch 2 will be the SAME setting as switch 1 for the 6003. Switch 2 will be the OPPOSITE setting as switch 1 for the 6004, 6005 and 6400. <p>Note: SW1, switch 7 MUST also be ON when using a secondary operator.</p>

SW 1 Switches continued on next page

2.2 DIP-Switches Continued

SW 1 (Top 8 Switches) continued

Switch	Function	Setting	Description
3	Exit Loop Port Output	OFF	Terminal #4 is output from plug-in exit loop detector installed in EXIT loop port.
	Open Input	ON (normal)	Terminal #4 is normal open command.
4	Auto-Close Timer	OFF	Auto-close timer is OFF. Manual input required to close gate.
		ON	Auto-close timer is ON. Adjustable from 1-23 seconds.
5	Reverse	OFF (normal)	Terminal #8 is a standard Reverse input.
	Not Used	ON	On setting is NOT used.
6	Overlapping Gates	OFF	Both operators start at the same time.
		ON	Secondary operator opens 1-2 seconds before primary operator. Vice-versa when closing.
7	Single	OFF	Switch must be OFF for single operator.
	Dual	ON	Switch must be ON when (dual) operators are used.
8	Input Power	OFF	Switch MUST be in the OFF position.

SW 1 Switch Definitions:

SW 1-Switch 1: PRIMARY motor direction switch - **Must** OPEN the primary gate upon initial AC power up and open command. If the open command begins to close the primary gate, turn AC power off and reverse this switch.

SW 1-Switch 2: SECONDARY motor direction switch - **Must** OPEN the secondary gate upon initial AC power up and open command. If the open command begins to close the secondary gate, turn AC power off and reverse this switch.

SW 1-Switch 3: Determines if the output of the loop detector (DoorKing plug-in loop detectors only) installed into the **EXIT loop port** will be sent directly to the microprocessor to open the gate (Normal), or if the output is directed to Terminal #4 where it can then be connected to other input terminals.

SW 1-Switch 4: Turns the auto-close timer on or off. Maximum time that the close timer can be set for is approximately 23 secs.

SW 1-Switch 5: **OFF** setting is Standard Reverse for a **CLOSING** gate. An input to terminal #8 (e.g.: N.O.-photo beam gets obstructed, **NOT** entrapment protection) **AND/OR** reverse loops get activated will stop and **reverse** the gate back to the full open position. If the auto-close timer is ON, when gate reaches the open position, timer **will not** close the gate. Another input command is needed to reset and close the gate. **DO Not** use the **ON** setting.

SW 1-Switch 6: When the gate overlap is **OFF**, the **DUAL** gate operators will start the open and close cycles at the **same time**. This is the normal setting for a **SINGLE** gate operator.

Turning the gate overlap **ON** when using dual gate operators will cause the secondary operator to start the **OPEN** cycle 1-2 seconds **before** the primary operator. The primary operator will start the **CLOSE** cycle 1-2 seconds **before** the secondary operator. This feature is useful when a magnetic lock is used to secure the gates.

SW 1-Switch 7: Sets up the circuit board for single or dual (Primary / Secondary) gate operation.

SW 1-Switch 8: Input power switch. Switch MUST be in the OFF position for the 115 VAC control box. **DO NOT** turn switch ON.

SW 2 (Bottom 4 Switches)

Switch	Function	Setting	Description
1 and 2	Relay Operation	1-OFF 2-OFF	Relay activates when gate is fully open.
		1-OFF 2-ON	Relay activates when gate is not closed.
		1-ON 2-OFF	Relay activates when gate is opening and open. Shadow loop setting if used.
		1-ON 2-ON	Relay activates when gate is opening and closing.
3	Maglock	ON	1-2 second delay to disengage maglock.
	Solenoid lock	OFF	5 second delay to disengage solenoid lock.
4	Spare	OFF	Leave in the OFF position.

SW 2 Switch Definitions:

SW 2-Switch 1 and 2: These work in conjunction with each other and determine when the relay on the board will be activated. This relay can be used as a switch for various functions such as illuminating a warning light when the gate is moving, or turning on a green light when the gate is full open. This relay is not available for these uses if it is being used for the shadow loop function.

SW 2-Switch 3: Used for a maglock (N.C.) when turned **ON**. Used for a solenoid lock (N.O.) when turned **OFF**.

SW 2-Switch 4: Spare switch. Leave in OFF position.

2.3 Limit Sensors Adjustment - Select your specific operator

The limit sensors on the operator **MUST** be adjusted to control the travel of the gate and to precisely set the **full** open and **full** closed position of the gate. Use **ONLY** the limit sensor instructions for your **SPECIFIC** operator type (6003, 6004, 6005 or 6400). This feature is especially useful in applications where the gate opens partially, such as on a curved driveway.

6003 Limit Sensors ONLY

Power to the circuit board must be ON when adjusting the limit sensors.

- A** Manually un-lock actuator arm with key and remove limit cover with 4 screws.
- B** Manually move the gate to the desired open or closed position. Loosen limit nut and slowly slide the limit assembly until the corresponding **LIMIT** LED on the circuit board lights up and tighten nut. Manually move the gate to other position. Repeat process with the other limit assembly.

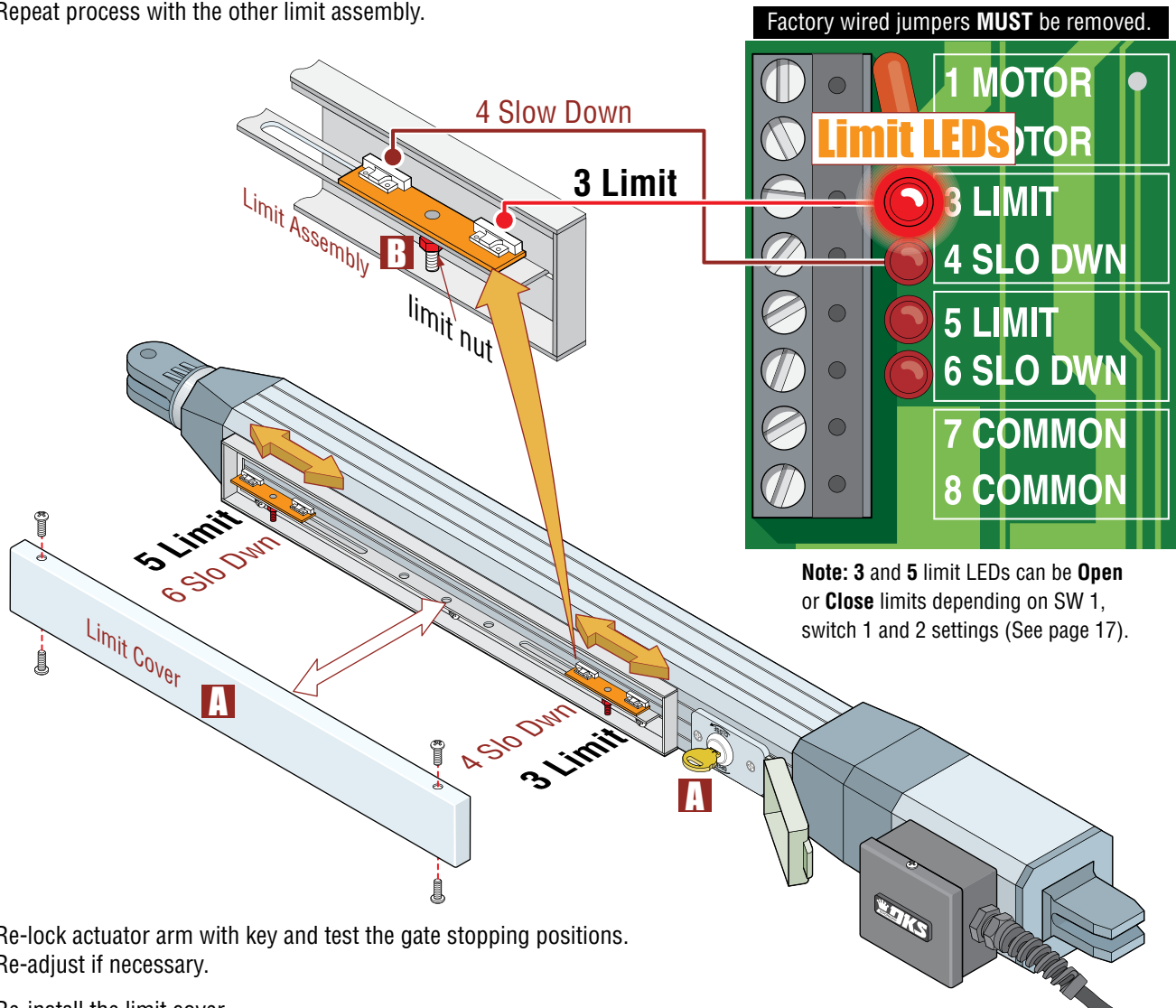

- C** Re-lock actuator arm with key and test the gate stopping positions. Re-adjust if necessary.
- D** Re-install the limit cover.
- E** Adjust the secondary actuator limit sensors if dual actuators have been installed. SW 1, switch 2 controls secondary actuator opening direction. SW 1, switch 7 **MUST** be ON when using dual actuators (See page 18).

IMPORTANT: The operator MUST OPEN GATE upon initial power up and OPEN command.

If the operator closes gate after giving first open command, shut off power and reverse DIP-switch SW1, switch 1 setting otherwise operator will **NOT** function correctly.

2.3 Limit Sensors Adjustment Continued

6004 Limit Switches ONLY

Power to the circuit board must be ON when adjusting the limit sensors.

The operator **MUST OPEN GATE** upon initial power up and **OPEN** command.

If the operator closes gate after giving first open command, shut off power and reverse DIP-switch SW1, switch 1 setting otherwise operator will **NOT** function correctly.

A With operator cover removed, un-lock operator with release tool to release arm.

B Manually move the gate to the desired open or closed position. Loosen adjustment screw and slowly spin the appropriate limit ring until the corresponding **LIMIT LED** on the circuit board lights up, then tighten screw. Manually move the gate to other position. Repeat process with the other limit ring.

C Re-lock operator with release tool and test the gate stopping positions. Re-adjust if necessary.

D Re-install the operator cover.

Limit Switch Adjustment Note:
Two thru-bolts 13 mm can be loosened to allow the electronic pallet to be moved around a little. **Make sure ALL 4 limit switches make good contact with the 2 limit rings.**

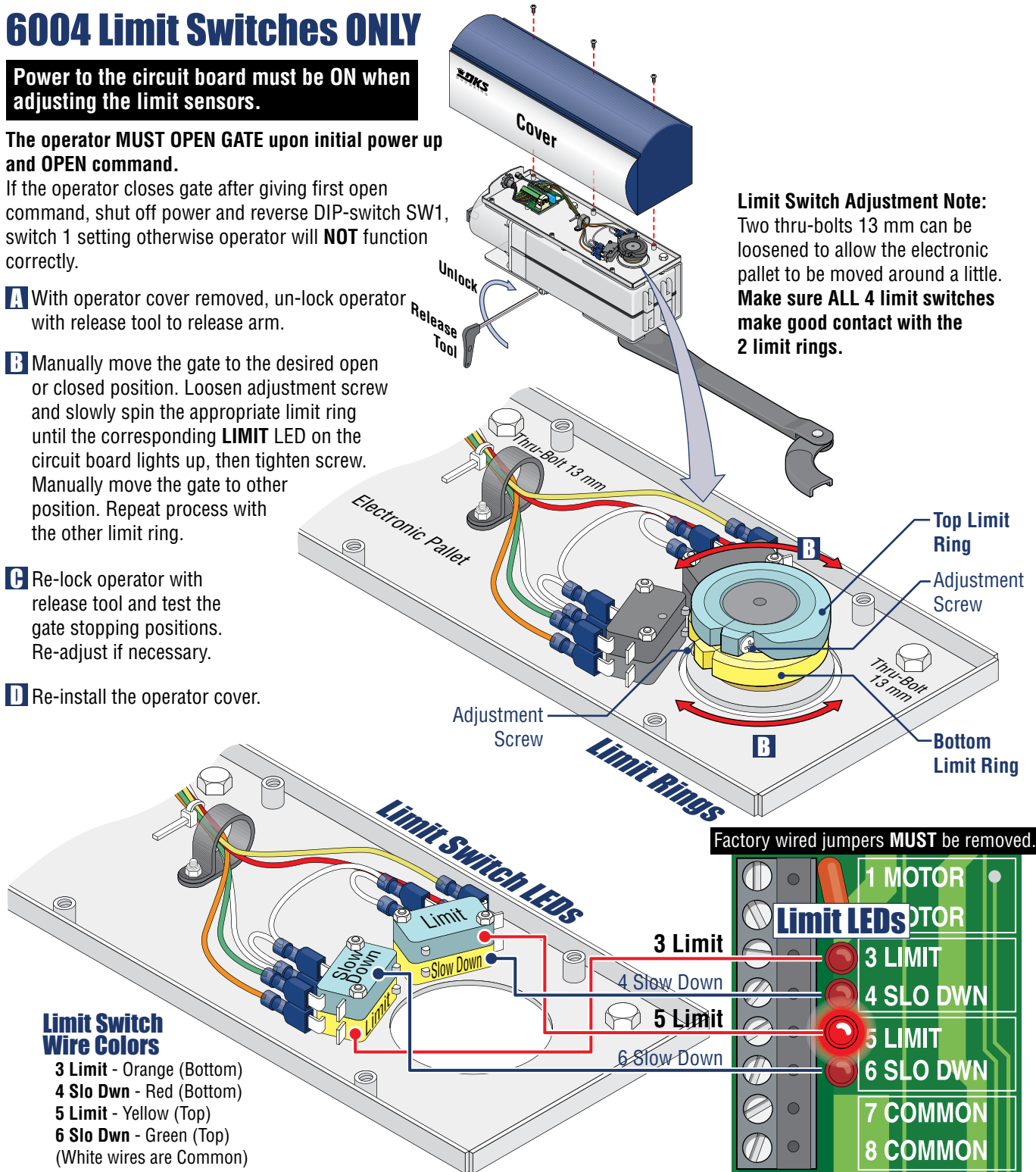

Limit Switch Wire Colors

- 3 Limit - Orange (Bottom)
- 4 Slo Dwn - Red (Bottom)
- 5 Limit - Yellow (Top)
- 6 Slo Dwn - Green (Top)
- (White wires are Common)

E Adjust the Secondary operator limit rings if dual operators have been installed. SW 1, switch 2 controls secondary operator opening direction. SW 1, switch 7 **MUST** be ON when using dual operators (See page 18).

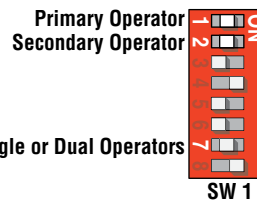

Factory wired jumpers **MUST** be removed.

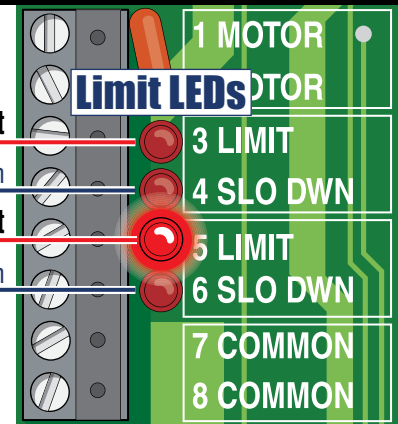

Note: 3 and 5 limit LEDs can be **Open** or **Close** limits depending on SW 1, switch 1 and 2 settings (See page 17).

2.3 Limit Sensors Adjustment Continued

6005 Limit Switches ONLY

Power to the circuit board must be ON when adjusting the limit sensors.

Factory wired jumpers **MUST remain connected** as shown. SLO DWN LEDs are always lit.

- A** Manually release 6005. See page 31.
- B** Remove the limit cover with one screw.
- C** Manually move the gate to the closed position. adjust **CLOSE** screw:
Clockwise increases the power shaft distance.
Counter-clockwise reduces distance.
5 LIMIT LED on the circuit board lights up when **CLOSE** switch has been activated.
- D** Manually move the gate to **OPEN** position. adjust **OPEN** screw:
Counter-clockwise increases the power shaft distance.
Clockwise reduces distance.
3 LIMIT LED on the circuit board lights up when **OPEN** switch has been activated.
- E** Re-lock 6005 and re-install the limit cover.
- F** Adjust the secondary 6005 limit sensors if dual actuators have been installed. SW 1, switch 2 controls secondary 6005 opening direction. SW 1, switch 7 **MUST** be ON when using dual actuators (See page 18).

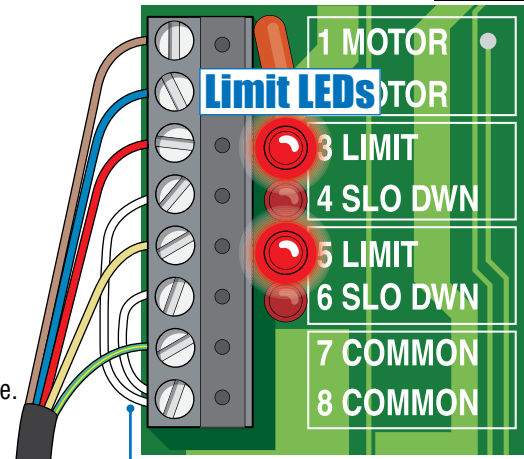

- E** Re-lock 6005 and re-install the limit cover.
- F** Adjust the secondary 6005 limit sensors if dual actuators have been installed. SW 1, switch 2 controls secondary 6005 opening direction. SW 1, switch 7 **MUST** be ON when using dual actuators (See page 18).

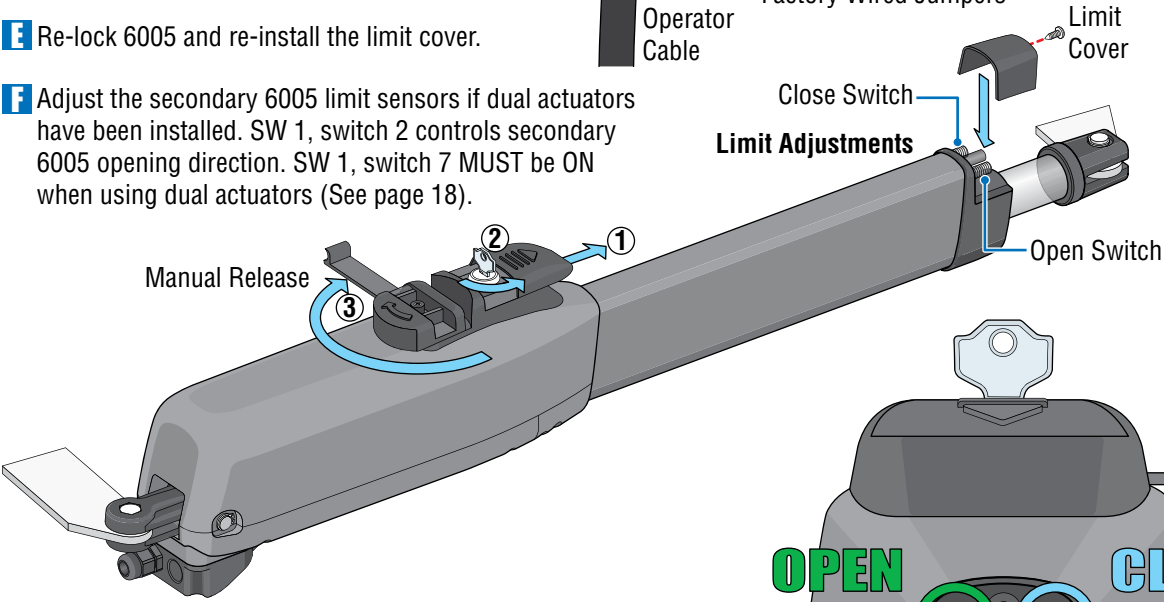

When finished setting limits, cycle operator a few times and re-adjust the open and close positions if necessary.

End View

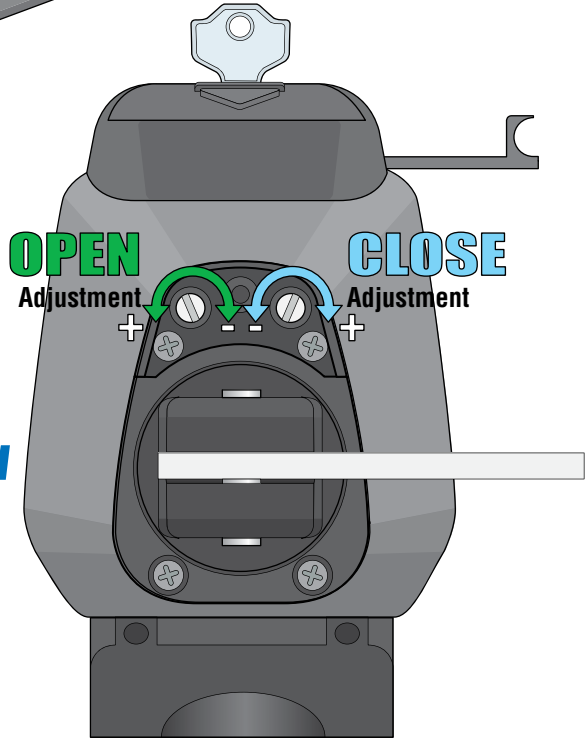

IMPORTANT: The operator MUST OPEN GATE upon initial power up and OPEN command.
If the operator closes gate after giving first open command, shut off power and reverse DIP-switch SW1, switch 1 setting otherwise operator will **NOT** function correctly.

2.3 Limit Sensors Adjustment Continued

6400 Limit Sensors ONLY

Power to the circuit board must be ON when adjusting the limit sensors.

A With operator cover plate removed, un-lock release handle and pull handle to release gate.

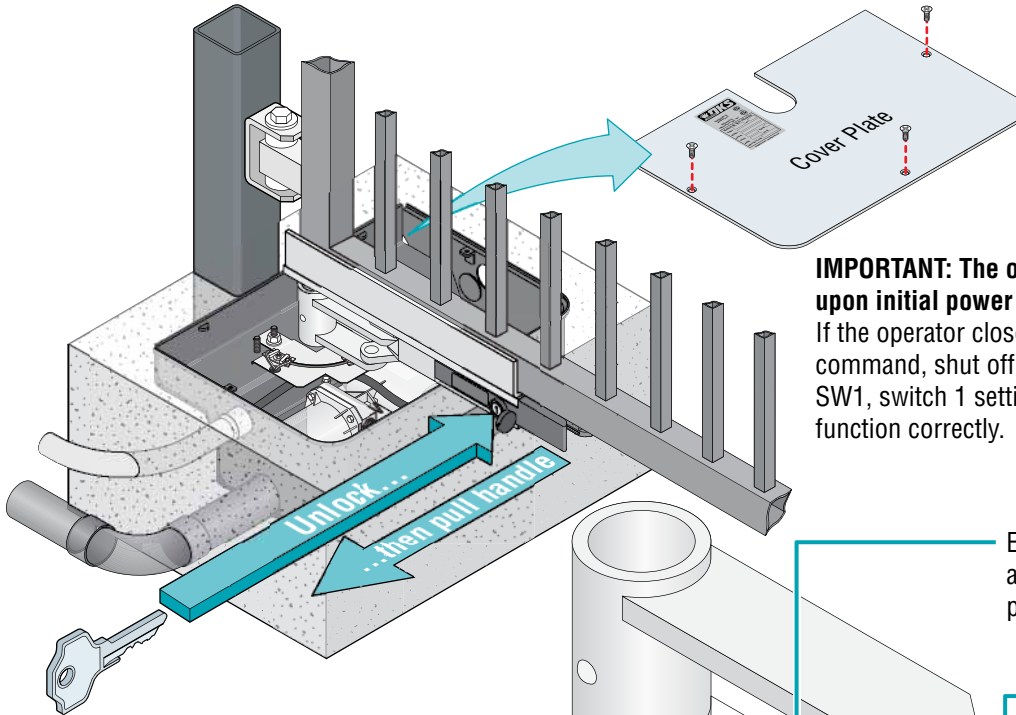

IMPORTANT: The operator MUST OPEN GATE upon initial power up and OPEN command. If the operator closes gate after giving first open command, shut off power and reverse DIP-switch SW1, switch 1 setting otherwise operator will **NOT** function correctly.

B Manually move the gate to the desired open or closed position. Loosen limit nut and slowly slide the limit assembly until the corresponding **LIMIT LED** on the circuit board lights up and tighten nut. Manually move the gate to other position. Repeat process with the other limit assembly.

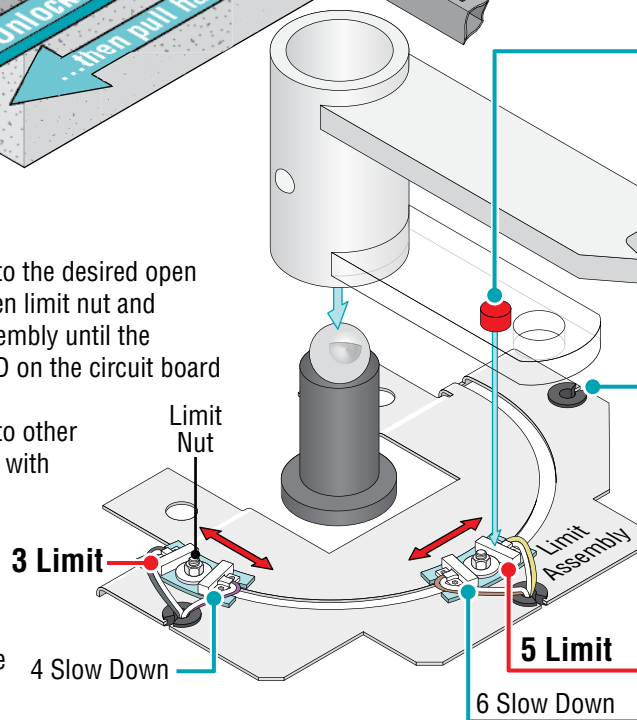

Embedded magnet on underside activates limit sensors when it passes over them.

Limit assembly positions may vary depending on the operator's drive motor orientation. Limit sensor wire color LEDs remain the same.

C Re-lock release handle with key and test the gate stopping positions. Re-adjust if necessary.

D Re-install the operator cover plate.

E Adjust the Secondary operator limit sensors if dual operators have been installed. SW 1, switch 2 controls secondary operator opening direction. SW 1, switch 7 **MUST** be ON when using dual operators (See page 18).

Factory wired jumpers MUST be removed.

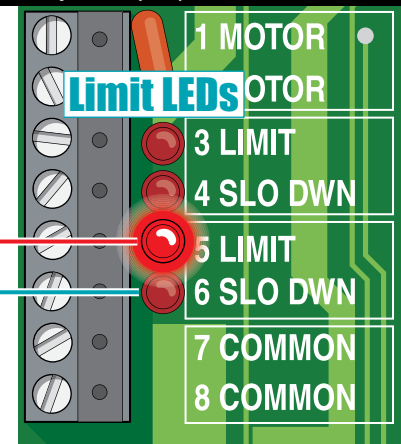

Limit Sensor Wire Color LEDs

- 3 Limit LED - Gray/White
- 4 Slo Dwn LED - Purple/White
- 5 Limit LED - Yellow/White
- 6 Slo Dwn LED - Brown/White

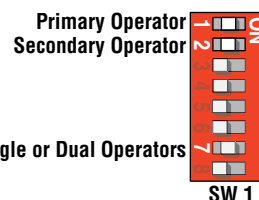

Note: 3 and 5 limit LEDs can be Open or Close limits depending on SW 1, switch 1 and 2 settings (See page 17).

2.4 Inherent Reverse Sensor Adjustment

This vehicular gate operator is equipped with an inherent (Built-In) adjustable reversing sensor (Type A) that is used as entrapment protection system according to the UL 325 standards. The gate will reverse direction upon encountering an obstruction in either the **opening or closing gate cycle**. For the reverse system to function correctly, the gate must be properly installed and work freely in both directions. A good set of roller bearing hinges is essential for proper swing gate operation.

The ideal adjustment will allow the operator to move the gate through its entire travel cycle without reversing, but will reverse upon contact with an obstruction with no more than 40 Lbs of force. This force can be measured with a gate scale.

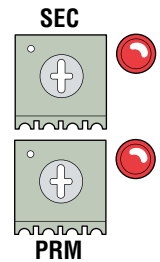

The amount of force required for the gate to reverse direction depends on the reverse sensitivity potentiometer.

Adjust the operators reversing sensitivity:

CAUTION: Keep pedestrians and vehicles clear of the gate while adjusting and testing sensors!

While operator has AC power:

- 1 Press the Full Open button to cycle the gate **OPEN**.



Note: "FULL OPEN" button will use the Auto-Close timer if turned ON (SW 1, switch 4 **ON**).

- 2 While gate is opening, slowly rotate PRM - **Primary** reverse sensor clockwise until the **reverse LED lights up** and the gate reverses direction. Rotate the primary reverse sensor back counter-clockwise approximately 1/8 turn to decrease the sensitivity (LED will turn off).

Note: The LED will light up during the first seconds of gate travel. Wait until it turns off before adjusting the reverse sensor.

- 3 Press the Full Open button (or wait for Auto-Close timer to time-out if turned ON) and **CLOSE** the gate. Make sure the gate closes completely. If it reverses and opens (**LED will light up**), rotate the primary reverse sensor counter-clockwise a little more to decrease the reverse sensitivity (LED will turn off). Cycle the gate a few times to be sure that it cycles completely in **BOTH** directions, re-adjusting the primary sensor as necessary.

Note: The LED will turn on briefly when AC power is turned on.

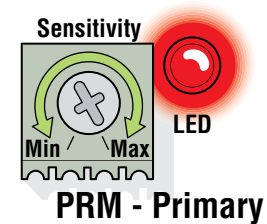

Safety Note: The LED will remain ON after a cycling gate gets obstructed during **normal** operation to indicate that the reverse sensor has been tripped. Always check the gate area for possible obstructions before putting operator back in service.

Dual Operators:

Secondary operator must be individually adjusted if dual operators have been installed. Use the **SEC - Secondary** reverse sensor.

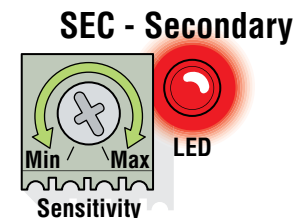

Test the operators reversing sensitivity:

Place an immobile object along the gate path, allowing the gate to strike it while in the **open** or **close** cycle. The gate must reverse direction after striking the object. If it does not, increase the reverse sensitivity (steps **2** and **3**) and repeat this test until the correct sensitivity has been set for the **OPEN** and **CLOSE** directions.

2.5 Shutdown Conditions

Under various entrapment conditions the operator will assume either a **SOFT** or **HARD (alarm)** shutdown. To determine what type of reset action is required, you will need to understand how the different entrapment conditions affect the gate operator.

Soft Shutdown

This occurs in various situations where the inherent or external entrapment protection devices have been activated. In a soft shutdown condition, the operator **will not** respond to any input that was present when the entrapment protection device sensed or encountered an obstruction. If the gate stops at the open position, the operator **will not** respond to the automatic close timer and a “manual input” is required to close the gate.

- **Example 1** - A time clock keys the gate open in the morning and an entrapment protection device senses an obstruction prior to the gate reaching the full open position. If the entrapment is sensed by the inherent system, the gate will reverse and run back to the closed position. The time clock input is still present, but the gate will not re-open.

Note: In some systems, the time clock input comes from the telephone entry system relay. This same relay may also provide open commands for a card reader, MicroPLUS transmitters and the visitor telephone entry. If so, these devices will also be disabled in a soft shutdown condition.

- **Example 2** - If the gate is closing and an entrapment protection device is activated, the gate will either stop or reverse and run back to the open position, depending upon if the secondary or inherent device was activated. The automatic close timer will not close the gate.
- **Example 3** - If a moving vehicle runs over a loop while the gate is cycling open and hits the opening gate, the operator's inherent entrapment protection is activated. The gate will reverse direction and run back to the closed position. A soft shutdown condition **does not occur** and the loop provides an immediate reset of the operator. Once the loop area is clear and another open command is given, the gate will cycle open.

Resetting a Soft Shutdown

In some conditions, a soft shutdown will reset as soon as the entrapment condition clears. For example, if a non-contact sensor (photo sensor) is sensing an obstruction, the operator will stop the gate and assume a soft shutdown condition. When the photo sensor clears (Obstruction is no longer there), the operator will return to normal operation.

When the operator is in a soft shutdown, activation of any “intended input” will reset the operator. An “intended input” includes any command input device, any standard safety input device and any loop input. Activating any of these inputs will reset the gate. At that point the gate will return to normal operation. If the gate is open, the automatic close timer will then time out and close the gate.

Continued on next page.

2.5 Shutdown Conditions Continued

Hard Shutdown (Alarm Activated)

A hard shutdown condition occurs when: (1.) The inherent entrapment protection system (Type A) gets activated TWO consecutive times before the gate completes the open or close cycle. (2.) The reversing edge (Type B2) gets activated and reverses but before the gate completes the reverse cycle the inherent entrapment protection system (Type A) gets activated.

- **Example of a Hard Shutdown** - The gate is closing and the inherent entrapment protection system senses an obstruction and causes the gate to reverse direction. As the gate begins to run in the open direction, a second obstruction is sensed prior to the gate reaching the full open position. Once the second obstruction has been sensed, the operator will stop, **the audio alarm will sound and all standard inputs are shut down** (including open commands, safety commands, loop inputs, etc.).
 - **To silence the alarm**, press the reset button or after 5 minutes, the audio alarm will shut off but will “chirp” every 5 seconds. This indicates that the operator is in a hard shutdown condition (The reset button must be pressed to reset the operator and stop the alarm “chirping”).

Resetting a Hard Shutdown

The operator is in a hard shutdown condition when the audio alarm is sounding OR “chirping” every 5 seconds.

- Before resetting a hard shutdown, determine why the shutdown occurred. Inspect the gate for any obstructions along its path that could have activated the inherent entrapment sensing system. Inspect the gate and gate hardware.

The audio alarm will sound for five minutes, or until the operator’s reset button is pushed. After (5) five minutes the alarm will “chirp every 5 sec.” and the hard shutdown condition will remain in affect until the reset button is pushed.

Note: DoorKing operators have a built-in alarm reset push buttons on the circuit board and on the bottom of the control box for quick access. Activating either one of these buttons will return the gate operator to normal operation, but **will not** activate the gate operator.

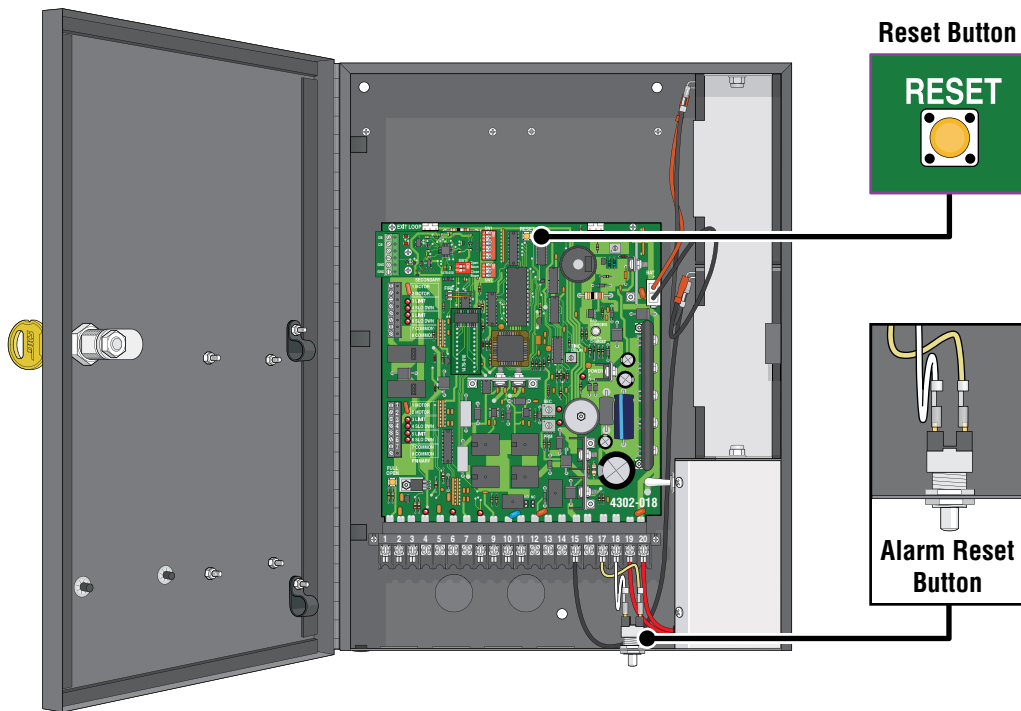

Once the gate has been reset, an open or close command is needed to start the gate operator. Most activating commands will cause the gate operator to cycle to the open position. This includes activation of a key switch or open command and activation of the automatic exit loop (If used). Activation of a close command will run the gate to the closed position.

SECTION 3 - MAINTENANCE AND TROUBLESHOOTING

Inspection and service of this gate operator by a qualified technician should be performed anytime a malfunction is observed or suspected. High cycle usage may require more frequent service checks.

3.1 Maintenance

When servicing the gate operator, always check any external reversing devices (loops, photo sensors, etc.) for proper operation. If external reversing devices cannot be made operable, do not place this operator in service until the malfunction can be identified and corrected.

Always check the inherent reversing system when performing any maintenance. If the inherent reversing system cannot be made operable, remove this operator from service until the cause of the malfunction is identified and corrected. Keeping this operator in service when the inherent reversing system is malfunctioning creates a hazard for persons which can result in serious injury or death should they become entrapped in the gate.

When servicing the gate operator, be sure that the AC power switch is turned OFF **AND** battery plug is disconnected (Page 15).

Operator Component	Maintenance	Monthly Interval		
		1	6	12
Warning Signs	Check that warning signs are on BOTH sides of the gate area.	✓		
Alarm	Activate the primary (inherent) reverse system by blocking the gate with a solid object. When the gate reverses, block the gate in the opposite direction prior to the limit being reached. The entrapment alarm should activate. Press the reset button to silence the alarm.	✓		
Batteries	Check the batteries for any leakage or loose connections. Batteries should be replaced every two years. P/N 1801-009. Two (2) required.	✓		
Fire Dept.	Check emergency vehicle access device for proper operation.	✓		
Gate	Inspect for damage. Check gate hinges for wear and grease if necessary.		✓	
Primary Reverse System	Check that the gate reverses on contact with an object in both the opening and closing cycles. Adjust the reversing sensor if necessary. See page 32.	✓		
Loop(s)	Check vehicular reverse and shadow loops for proper operation.	✓		
Manual Release	Check manual release for proper operation. See page 31.	✓		
External Entrapment Device	Check monitored external reverse device(s) stop or reverse the gate when activated. See page 32.	✓		
Complete System	Complete check of gate and gate operating system.			✓

3.2 Diagnostics Check

Have the following diagnostic tools available: VOM meter with minimum voltage memory or min-max range to check voltage and continuity. Meg-ohm meter capable of checking up to 500 megohms of resistance to properly check ground loop integrity. A malfunction can be isolated to one of the following:

- Gate Operator
- Loop System
- Keying Devices.

Disconnect all external inputs to the circuit board.

1. Check the input indicator LED's. They should only come ON when a keying device (card reader, push button, etc.) is activated. If any of the input LED's are ON continuously, this will cause the gate operator to hold open. Disconnect the keying devices one at a time until the LED goes OFF (see troubleshooting guide).
2. If the operator stops or holds open, check external entrapment protection devices for any shorts or malfunction.
3. A malfunction in a loop or loop detector can cause the gate operator to hold open, or not detect a vehicle when it is present over the loop. Pull the loop detector circuit boards from the loop ports on the operator circuit board. If the malfunction persists, the problem is not with the loop system. For more information refer to the loop detector instruction sheet and the DoorKing Loop and Loop Detector Information Manual. Continued on next page.

3.2 Diagnostics Check Continued

4. Check that there are no shorted or open control wires from the keying devices to the gate operator. If a keying device fails to open the gate, momentarily jumper across terminals 1 and 2 on the control board. If the gate operator starts, this indicates that a problem exist with the keying device and not with the gate operator.

5. Check the supply voltage and batteries. A voltage drop on the supply line (usually caused by using too small supply voltage wires) will cause the operator to malfunction. Batteries should be fully charged for proper operation, replace batteries every two years on average.

3.3 Troubleshooting

Symptom	Possible Solution(s)
Operator(s) will not run. Power LED is OFF.	<ul style="list-style-type: none"> • Check that AC power to the operator is turned ON. • Check battery power. • Check for 24 VAC at terminals 19 and 20. If voltage measures OK, check terminal strip or replace the circuit board.
Operator(s) will not run. Power LED is ON.	<ul style="list-style-type: none"> • Insure that a minimum of one (1) external entrapment protection device is connected in EACH entrapment area and the inputs are connected and enabled (UL 325 DIP-switches are turned ON). • Momentarily jumper terminal 1 to terminal 2. If the input LED does not come ON, check the terminal strip or replace the circuit board. If LED does come ON, proceed to next steps. • Check the fuses. • Check Motor(s): Remove the circuit board. With two 14 AWG insulated jumper wires, momentarily jumper the battery terminals to the motor terminals (1, 2) of the Primary operator connector. The operator should run. Swap the two wires at the terminal strip. The operator should run in the opposite direction. Repeat these steps using the Secondary operator connector. • If the operator(s) run in both directions in the step above, replace the control board. If the operator(s) do not run, or run in only one direction, problem can be a bad operator, wire connections from the control board to the operator(s) or a bad control board.
Operator will not run, entrapment protection input(s) LED is ON.	<ul style="list-style-type: none"> • The entrapment protection device has a fault or the wiring to it is shorted.
Operator will not run, entrapment protection input(s) LED is Blinking.	<ul style="list-style-type: none"> • The entrapment protection device is not connected or the wiring to it is open.
Gate opens a short distance, then stops and reverses.	<ul style="list-style-type: none"> • Check the reversing sensitivity. • Check the secondary safety devices. • Disconnect the gate from the gate operator and check that the gate swings freely without any binding. • Continue troubleshooting or replace the circuit board.
Gate opens but will not close.	<ul style="list-style-type: none"> • Check the input LEDs. Any ON will hold the gate open and indicates a problem with a keying device. • Check the secondary safety devices. Any activated will hold the gate open and indicates a problem with the safety device. • Check the loop detectors. Any activated can hold the gate open and indicates a problem with the loop detector or ground loop. • Operator may be in a "soft shutdown." Activate any keying device to determine if operator returns to normal operation. • If automatic close is desired, be sure SW 1, switch 4 is ON.
Gate closes but will not open.	<ul style="list-style-type: none"> • Operator may be in a "soft shutdown." Check input LEDs. If any are ON, momentarily disconnect, then re-connect the wire going to the respective terminal. Operator should open. • Check to be sure that the operator is running in the proper direction. Turn power OFF, and then back ON. Activate a keying device. Operator should run in the open direction. If operator runs in the close direction, turn power OFF and change direction switch SW 1, switches 1 and/or 2. Go to above section if operator now opens but will not close. • Be sure that the respective LED on the control board lights when the keying device connected to the respective terminal is activated. If LED does not light, momentarily place a jumper wire from terminal 1 to the input terminal being checked. If LED lights and gate opens, problem is with the keying device. If LED does not light, replace control board. • Check motor as described above "Operator(s) will not run. Power LED is ON".
Operator has intermittent functionality problems that vary.	<ul style="list-style-type: none"> • The main terminal #3 250 mA power has been exceeded. Check total amp draw of connected device(s).

3.4 Accessory Items

UL 325 Monitored Entrapment Protection Devices available for the 115 VAC Control Boxes.

Type B2 Contact Sensors (Reversing Edge)

- Miller Edge Sensing Edges - all models with a T2 (resistive) termination.
- Miller Edge wireless monitored transmitter/receiver kit model RB-G-K10
- ASO GMBH Sentir GF Series sensing edges

Type B1 Non-contact Sensors (Photo Cell)

- Miller Edge Reflective-Guard Model RG
- Miller Edge Prime-Guard Model PG
- EMX Industries Model IRB-MON
- EMX Industries Model IRB-RET
- Omron Model E3K-R10K4
- Seco-Larm Model E-936-S45RRGQ
- Seco-Larm Model E-960-D90GQ

Monitored Expansion Kit

- Miller Edge Multi-Input Module Model MIM-62

Accessory items available for the 115 VAC Control Boxes.

Plug-In Loop Detector - Detectors plug directly into ports on circuit board simplifying wiring.

- Single channel detector - P/N 9410-010
- Dual channel detector - P/N 9409-010
- Single channel detector with aux relay - P/N 9411-010
- Single channel low power draw detector - P/N 9416-010
- Dual channel low power draw detector - P/N 9415-010

External Loop Detector

- Reno A&E 12/24 VDC or 24 VAC - 9402-045
- Reno A&E 120 VAC - 9402-047
- Carlo Gavazzi 24 VAC/VDC - 9402-044
- Diablo 10-30 VAC/VDC low power draw - 9402-050

Magnetic Lock - Magnetic Gate Lock Kit provides an excellent means to secure swing gates and is a fail-safe device allowing emergency vehicle access upon power outage. P/N 1216-080 and P/N 1216-081

Interconnect Cable - Interconnect wire cable contains all the necessary wires to interconnect primary / secondary operators.

Cable length 30 feet. P/N 2600-755 Cable length 40 feet. P/N 2600-756 Cable length 50 feet. P/N 2600-757

Time Clock - 7 day time clock can be used to automatically open gate at pre-set time and days. Compact clock fits inside the operator.

P/N 2600-791 - 7 day clock

Torsion Rods - Torsion rod assembly is used on uphill swing gates for counter balance. P/N 1203-084

Hinges - Heavy-duty ball bearing hinges provide easy swing gate operation. P/N 1200-009, P/N 1200-019, P/N 1200-039.

Surge Devices - High and low voltage surge suppressors help prevent circuit board failure caused by lightning strikes and power surges.

P/N 1879-010 - High Voltage P/N 1878-010 - Low Voltage

Speed Bumps - Prefabricated six-foot speed bump reduces traffic speed through gate system. P/N 1610-150

Battery - 12 Volt 3 Amp Hour. P/N 1801-009. Two (2) required.

115 VAC Standard or Deluxe Control Box

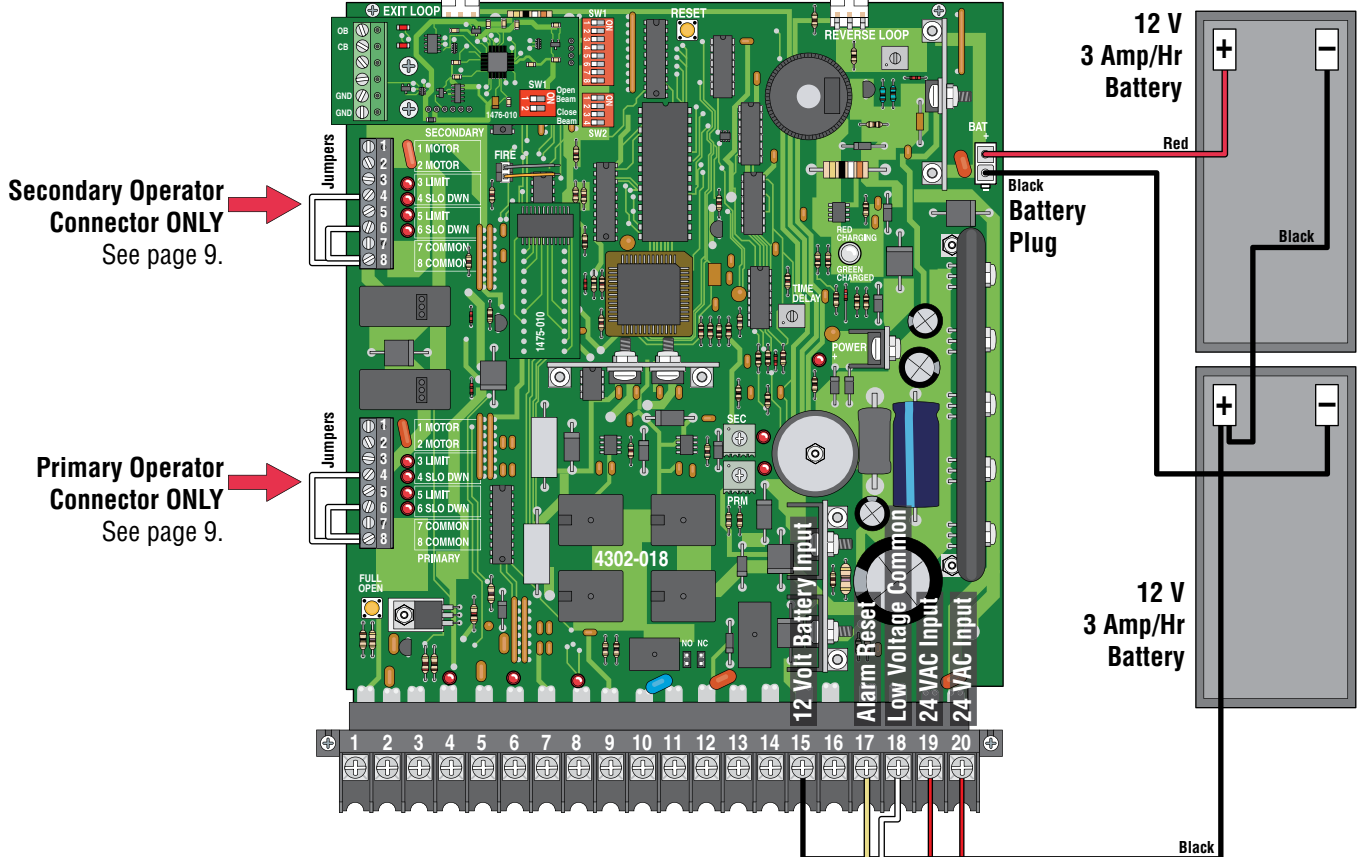

P/N 4302-112

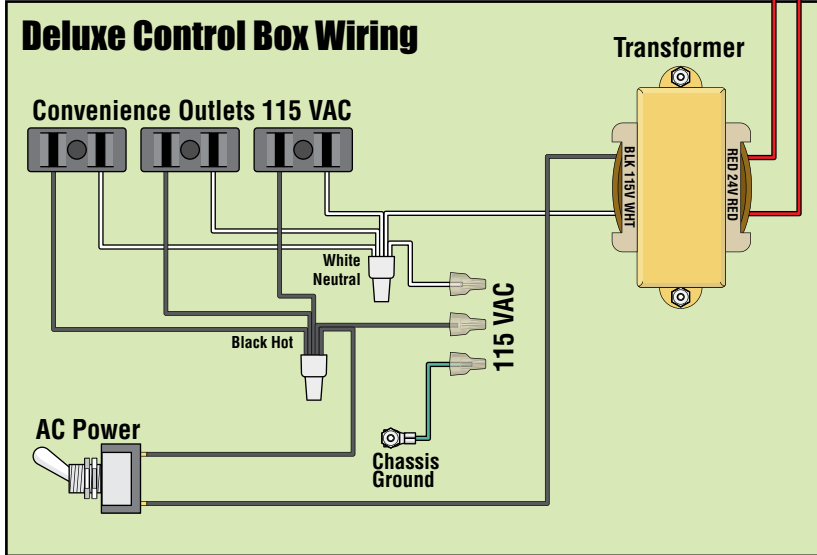

P/N 4302-111

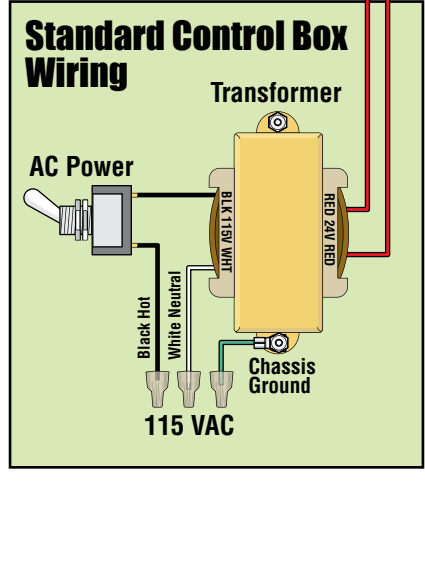

IMPORTANT INFORMATION FOR OWNER

Shut-Off ALL Power to Operator OR Shut-Off Alarm

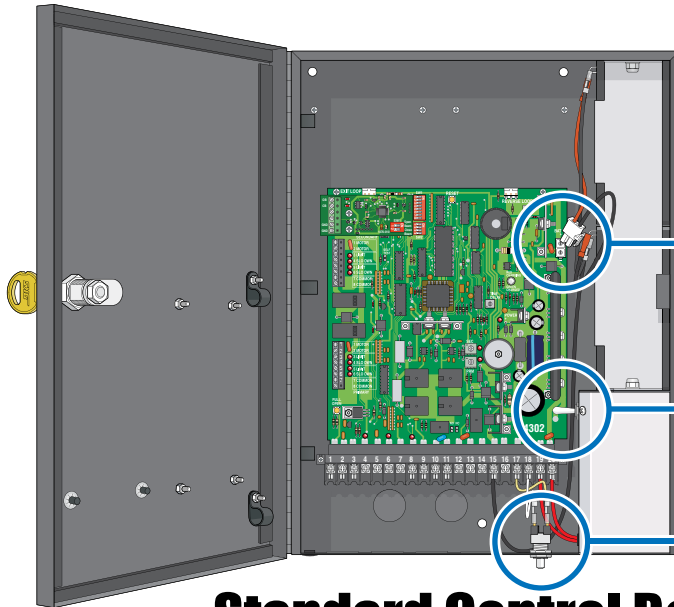

Standard Control Box

Shut-Off ALL Power

Turn OFF AC power switch
AND carefully disconnect battery
plug from circuit board to
shut-off **ALL** power to operator.

Shut-Off Alarm

Push button to SHUT-OFF alarm.
ALWAYS inspect the gate, gate hardware
and any obstructions along the gate's
path that could have activated the alarm
BEFORE pressing the reset button and
putting the gate back into service. If the
gate is malfunctioning, **DO NOT** put it
back into service until the problem can
be corrected.

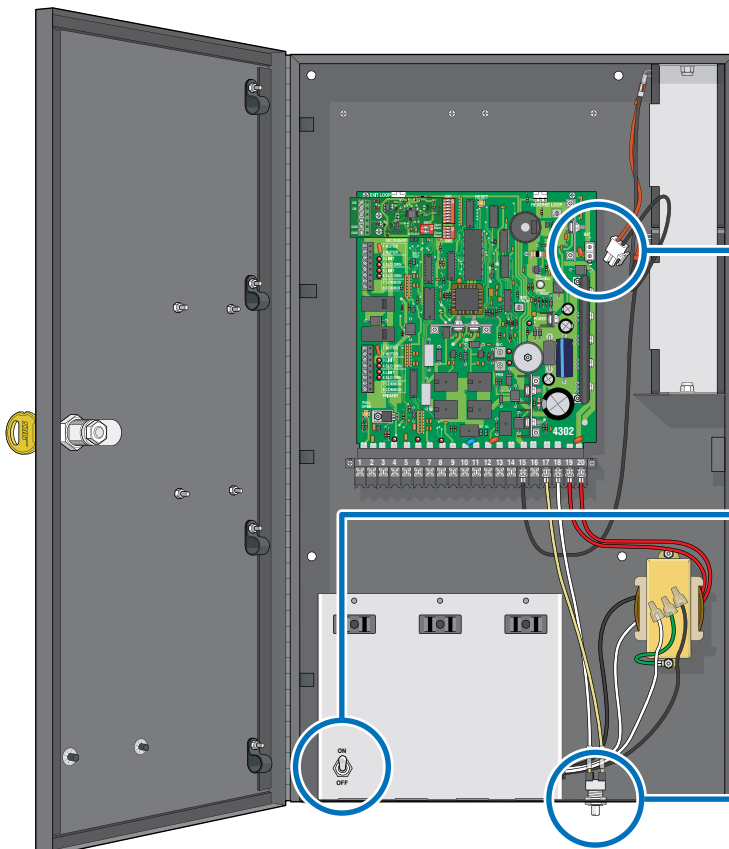

Deluxe Control Box

Shut-Off ALL Power

Turn OFF AC power switch
AND carefully disconnect battery
plug from circuit board to
shut-off **ALL** power to operator.

Shut-Off Alarm

Push button to SHUT-OFF alarm.
ALWAYS inspect the gate, gate hardware
and any obstructions along the gate's
path that could have activated the alarm
BEFORE pressing the reset button and
putting the gate back into service. If the
gate is malfunctioning, **DO NOT** put it
back into service until the problem can
be corrected.

IMPORTANT INFORMATION FOR OWNER

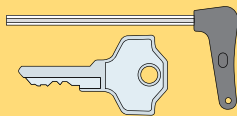

A **RELEASE TOOL (6004)** or a **KEY (6003, 6005 & 6400)** has been supplied that will unlock the gate operator.

Note: The **OWNER** of the gate operator is responsible for the **KEY** or **RELEASE TOOL** availability.

Manually Operating the Gate (NO Power)

Choose your operator model and follow directions to un-lock the operator and manually move the gate.

6003 Manual Release ONLY

ALL power to the operator must be OFF BEFORE manually operating gate (See previous page).

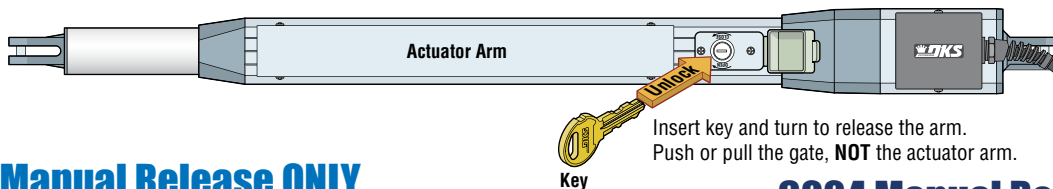

Insert key and turn to release the arm.
Push or pull the gate, **NOT** the actuator arm.

6005 Manual Release ONLY

ALL power to the operator must be OFF BEFORE manually operating gate (See previous page).

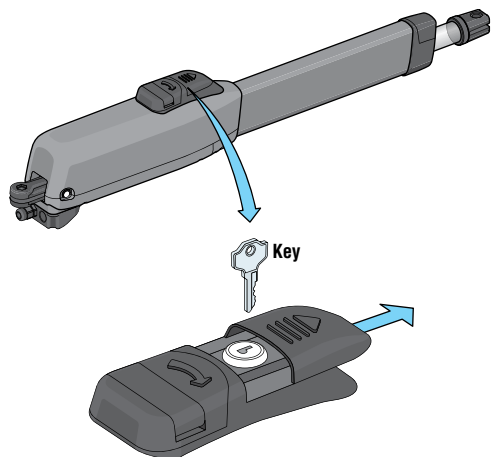

1. Slide door open and insert key.

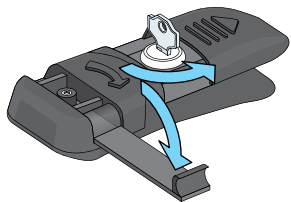

2. turn key 90° and flip handle out.

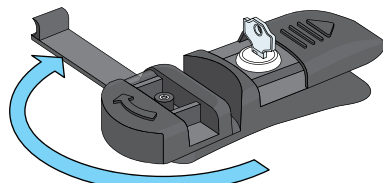

3. Rotate handle 180°.

Gate can now be manually moved.
Push or pull the gate, **NOT** the operator.

6004 Manual Release ONLY

ALL power to the operator must be OFF BEFORE manually operating gate (See previous page).

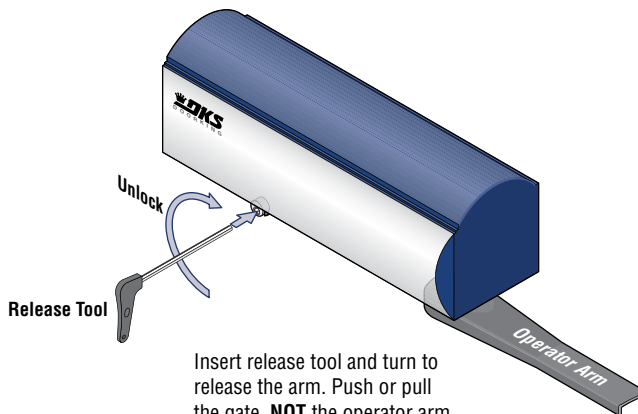

Insert release tool and turn to release the arm. Push or pull the gate, **NOT** the operator arm.

6400 Manual Release ONLY

ALL power to the operator must be OFF BEFORE manually operating gate (See previous page).

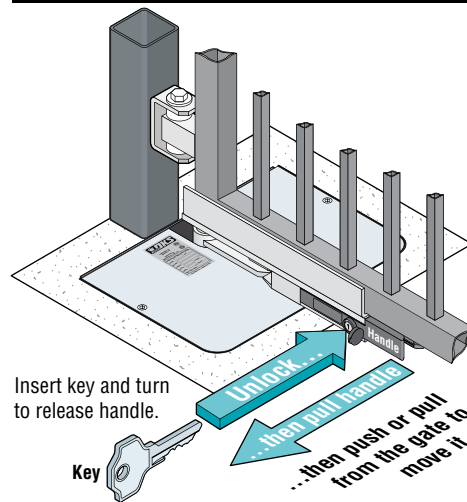

Insert key and turn to release handle.

Unlock...
...then pull handle
...then push or pull from the gate to move it.

IMPORTANT INFORMATION FOR OWNER

Gate Operator's Monthly Checkup

Caution: Make **SURE** gate area is clear **BEFORE** testing the gate operator!

DO NOT repair or adjust gate systems yourself. Contact a trained gate systems technician with any questions or to make any repairs or adjustments. If you feel uncomfortable performing any of these inspections or testing, a qualified service technician will perform the visual inspections and testing for you.

You can find a trained service technician at DoorKing's "Dealer Locator" at www.doorking.com

Visual Inspection

Visually inspect the rollers, fasteners, brackets and other gate hardware for proper alignment, proper tightness, and signs of damage, breakage, looseness, rust or wear. Moving parts should be lubricated and should not be squeaking.

Visually inspect wiring for fraying or exposure. If a malfunction is found, contact a trained service technician to make adjustments or repairs.

Test Built-In Reversing Sensor

Begin with the gate in the fully **OPEN** position. Stand just outside the path of the gate and close the gate (typically auto-timer will time-out and close gate automatically). As the gate is **closing**, firmly press a solid object against the end of the gate frame in the direction opposing the travel of the gate. The gate should **stop** within 2 sec. and **reverse** to the **OPEN** position. Another input command is needed before the gate will reset and close again. Repeat this test while **opening** the gate. Start from the fully **CLOSED** position. While **opening**, gate should **stop** and **reverse** to the **CLOSE** position. If gate does **NOT** respond like it should in **either** direction of gate travel, contact a trained service technician to make adjustments or repairs.

Test Photo Sensors

If the gate has a photo sensing device protecting the path of a **closing gate**, perform the following test. Begin with the gate in the fully **OPEN** position. Stand just outside the path of the gate and close the gate (typically auto-timer will time-out and close gate automatically). Pass an object across the path of the closing photo sensing beam. The gate should **stop** within 2 sec. and **reverse** to the **OPEN** position. Typically the auto-timer times out and gate closes again.

If the gate has a photo sensing device protecting the path of a **opening gate**, start from the fully **CLOSED** position. **OPEN** gate. Pass an object across the path of the opening photo sensing beam. The gate should **stop**, the gate will resume opening when the beam is clear. If gate does **NOT** respond like it should in **either** direction of gate travel, contact a trained service technician to make adjustments or repairs.

Test Reversing Edges

If the gate has a reversing edge(s) protecting the path of a **closing gate**, perform the following test. Begin with the gate in the fully **OPEN** position. Stand just outside the path of the gate and close the gate. As the gate is closing, firmly press a solid object against the reversing edge in the direction opposing the travel of the gate. The gate should **stop** within 2 sec. and **reverse** to the **OPEN** position (typically auto-timer will time-out and close gate automatically). If the gate encounters **another** obstruction before it is closed, the gate will **stop** and reverse to the **OPEN** position **again**. A input command is needed before the gate will reset and close again, auto-timer will **NOT** close gate (Typically, press your remote button for input command).

If the gate has a reversing edge(s) protecting the path of a **opening gate**, starting from the fully **CLOSED** position. Stand just outside the path of the gate and open the gate. **OPEN** gate. As the gate is opening, firmly press a solid object against the reversing edge in the direction opposing the travel of the gate. gate should **stop** and **reverse** to the **CLOSE** position. If gate does **NOT** respond like it should in **either** direction of gate travel, contact a trained service technician to make adjustments or repairs.

Note: This gate operator uses high levels of force to move the gate and most people underestimate the power of these systems and do not realize the potential hazards associated with this system if **NOT** maintained properly.

Scheduled maintenance visits are offered by most qualified service technicians to MAINTAIN your gate operator system.

Wiring / Owner's Manual

115 VAC Control Boxes for

6003, 6004, 6005 and 6400 gate operators

Use this manual for circuit board 4302-018 Revision A or higher.

4302-065-Z-1-19

Entrapment Protection must be provided for the gate system where the risk of entrapment or obstruction exists. The operator will NOT run without one or more monitored type B1 or B2 entrapment protection devices in EACH entrapment area.

UL 325 August 2018 Standard



THIS PRODUCT IS TO BE INSTALLED AND SERVICED BY A TRAINED GATE/DOOR SYSTEMS TECHNICIAN ONLY.
Visit www.doorking.com/dealer-locator to find a professional installing and servicing dealer in your area.

www.doorking.com

DoorKing, Inc.
120 S. Glasgow Avenue
Inglewood, California 90301
U.S.A.
Phone: 310-645-0023
Fax: 310-641-1586