

Installation/Owner's Manual

1838 Access Plus

PC Programmable Access Control System

Use this manual for circuit board 1970-010 Revision U or higher.

1838-066-J-10-20

Control a main door, gate and six additional RS-485 entry points.

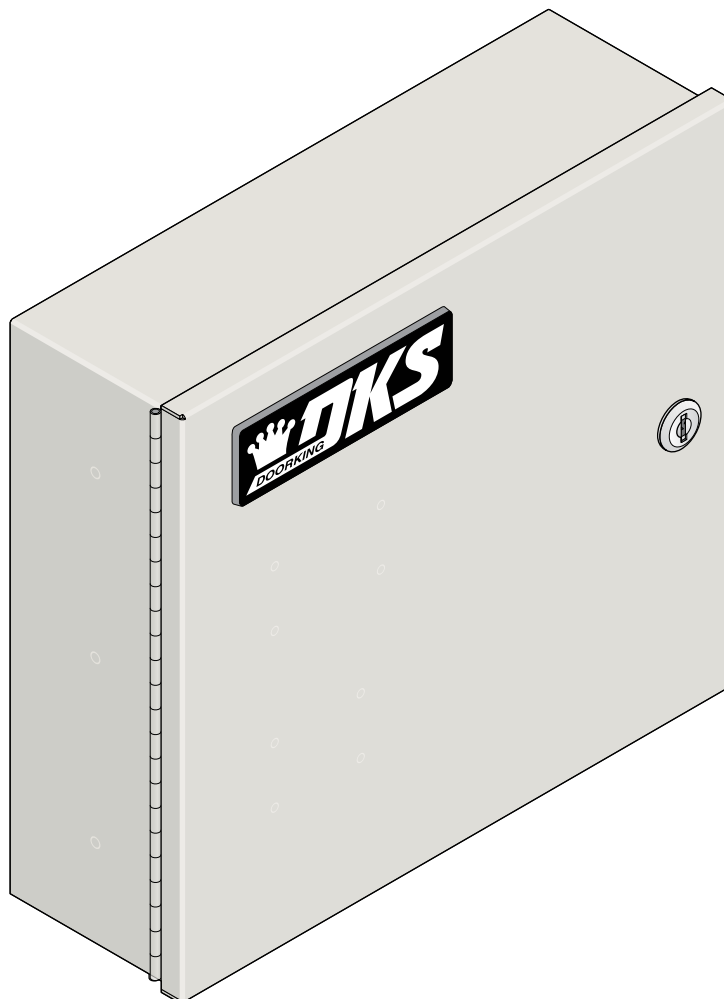

Date Installed: _____

Installer/Company Name: _____

Phone Number: _____

Circuit Board
Serial Number
and Revision Letter: _____

Leave Manual with Owner

Download **ACCESS PLUS ACCOUNT MANAGER** Software **FREE** at:
<http://www.doorking.com/accessories/access-plus-software>

Copyright 2019 DoorKing®, Inc. All rights reserved.



Conforms To UL STD 294
Certified To CAN/ULC-S319-05



QUICK GUIDE: Terminals & LED Descriptions

- Phone In** (Twisted Pair)
1. Phone In (Negative - Ring)
 2. Phone In (Positive - Tip)
 3. Ground (Required)
 4. Not Used
 5. Not Used
 6. Not Used.

(Optional - Phone modem programming or remote touch-tone phone control only)

18-PIN Terminal

- Emergency and/or Postal Entry Switch**
7. Switch Input Relay 1. A switch closure across terminals 7 & 9 will activate relay 1 for its programmed strike time.
 8. Switch Input Relay 2. A switch closure across terminals 8 & 9 will activate relay 2 for its programmed strike time.

- Optional Standby Battery Power**
9. - 12 VDC Battery Negative. Also **Common** for terminals 7 & 8.
 10. + 12 VDC Battery Positive (12 VDC, .7 Ah, SLA).

- Relay 1** (Access Control Device)
11. Relay 1 Normally Open
 12. Relay 1 Normally Closed
 13. Relay 1 **Common**

- Relay 2** (Access Control Device)
14. Relay 2 Normally Open
 15. Relay 2 Normally Closed
 16. Relay 2 **Common**

- Input Power (Transformer)**
17. 16.5 VAC Input Power
 18. 16.5 VAC Input Power

WARNING Maximum input voltage to terminals 9 and 10 is 14.5 Volts DC.

BATT CHARGE LED: When battery is connected to 9 and 10, Green LED will light when charging and turn OFF when charged.

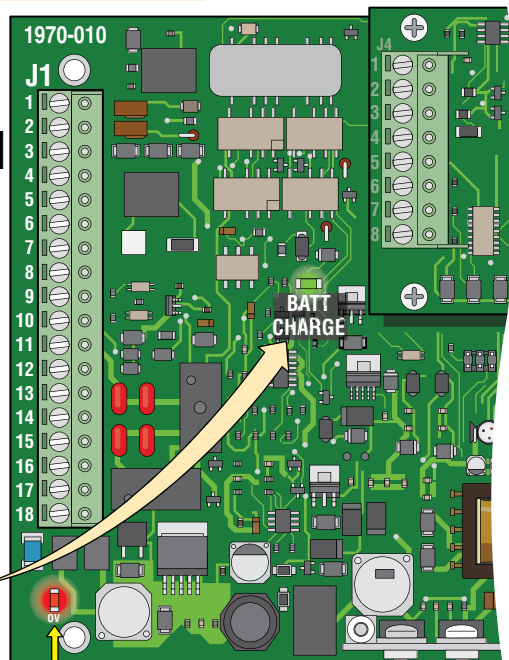

Over Voltage Power Note: OV LED will light up if too much power is applied to circuit board.

DO NOT use 24V

Do Not Connect Power to a Receptacle Controlled by a Switch

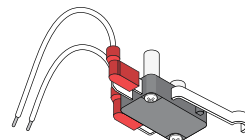
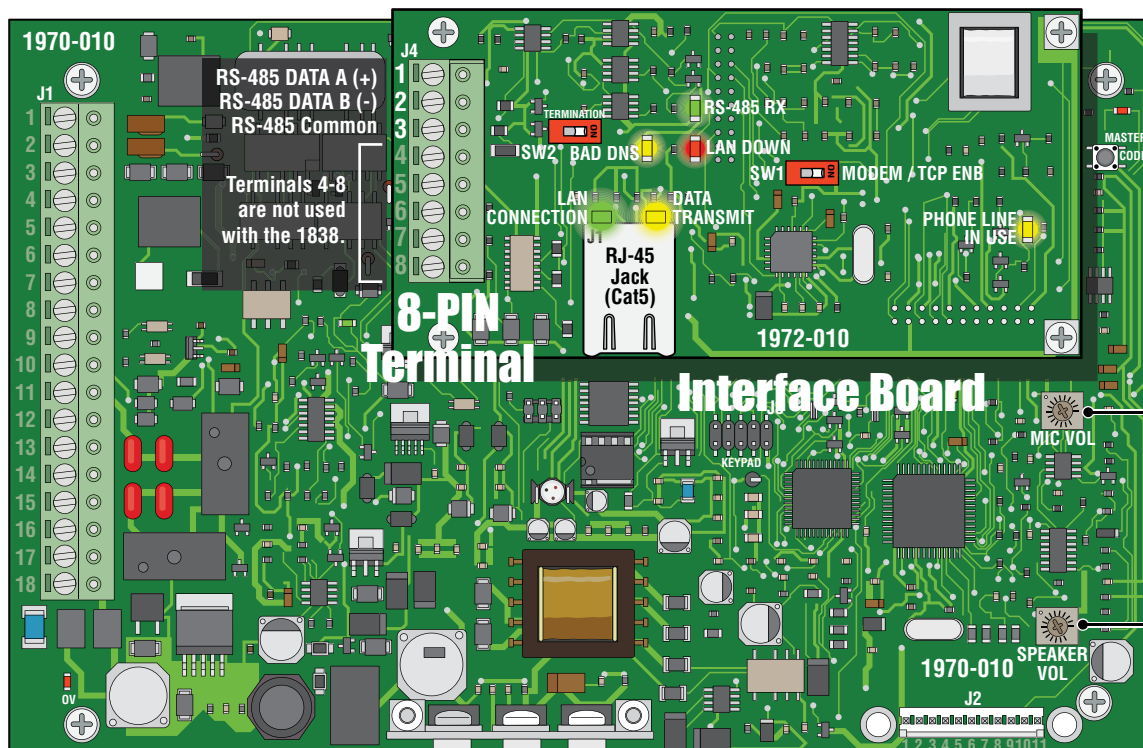

UL 294 Tamper Switch
Note: Located at top of enclosure board (See Section 1.10).

Microphone Gain Adjust

Speaker Volume Adjust

RS-485 RX - Green LED indicates that the system is on-line and scanning the RS-485 devices.

BAD DNS - Yellow LED indicates an email server problem, rejecting the mail server.

LAN DOWN - Red LED indicates a problem with the LAN. IP or Gateway (router) down or wrong gateway IP address.

PHONE LINE IN USE - Yellow LED indicates that the phone line is being used (dial-out, call forwarding, etc.).

LAN CONNECTION - Green LED indicates that the wire connection from the unit to the computer or router is good.

DATA TRANSMIT - Yellow LED indicates that the TCP / IP connection is transmitting data or sending an email.

SW1 - Modem/TCP Enable - Turning SW1 Off disables the modem and TCP / IP, but will speed up programming from the keypad.

SW2 - Termination Switch - Only used when RS-485 access control devices are being used (See section 1.9.1).

Quick Reference Table

NOT Programmable from Software,
Program from System Keypad ONLY.

	Page #	Section	Command	Factory Settings
Section 2.1 Programming Master Code				
Program a Master Code	18	2.1	Press Master Code Button	NO Master Code Programmed
Section 2.3 Programming Network Setup for a Computer				
Set the Unit's IP Address (reboot required)	20	2.3.1	* 5 1	192.168.001.030
Sub-Net Mask (reboot required)	20	2.3.2	* 5 2	255.255.255.000
Set the Gateway (Router) IP Address (reboot required)	21	2.3.3	* 5 3	192.168.001.001
Set the Port Number (reboot required)	21	2.3.4	* 5 6	01030
Enable / Disable TCP / IP Support - System Reboot	21	2.3.5	* 5 0	0
Section 2.4 System Parameters Programming				
Relay Strike Time	24	2.4.7	* 0 3	1 Sec
Tone Open Numbers	24	2.4.8	* 0 5	Relay 1: 9 8 7 6 Relay 2: 5 4 3 2 Relays 3-8 Not Set
Answer Incoming Call on X Rings (Phone Line Required)	24	2.4.9	* 1 8	06 (6 Rings)
Section 2.6 Access Codes for Access Control Devices				
Device Access Code Programming "Time Zone Restricted"	25	2.6.4	* 7 0	Empty
Delete a Device Access Code	25	2.6.5	* 7 1	N / A
Delete All Device Access Codes for Same Type of Device	25	2.6.6	* 7 2	N / A
Section 2.7 Time Functions				
Time and Date Calendar Chip Programming	26	2.7.1	* 3 3	Empty
Automatic Relay Activation Time Zone Programming (Up to 4 zones)	26	2.7.5	* 3 5	Empty
Access Code Time Zone Programming (Up to 4 zones)	27	2.7.6	* 3 6	Empty
Section 2.8 Miscellaneous				
Restore Factory Settings	27	2.8.1	* 9 0	N / A
Erase Transaction Log	27	2.8.2	* 9 1	N / A

Note: Program section numbers have been intentionally skipped that **DO NOT** apply to the 1838 Access Plus system in this manual. This allows **ALL** of the Access Plus manuals to remain in sync with each other when referencing programming numbers.

SPECIFICATIONS

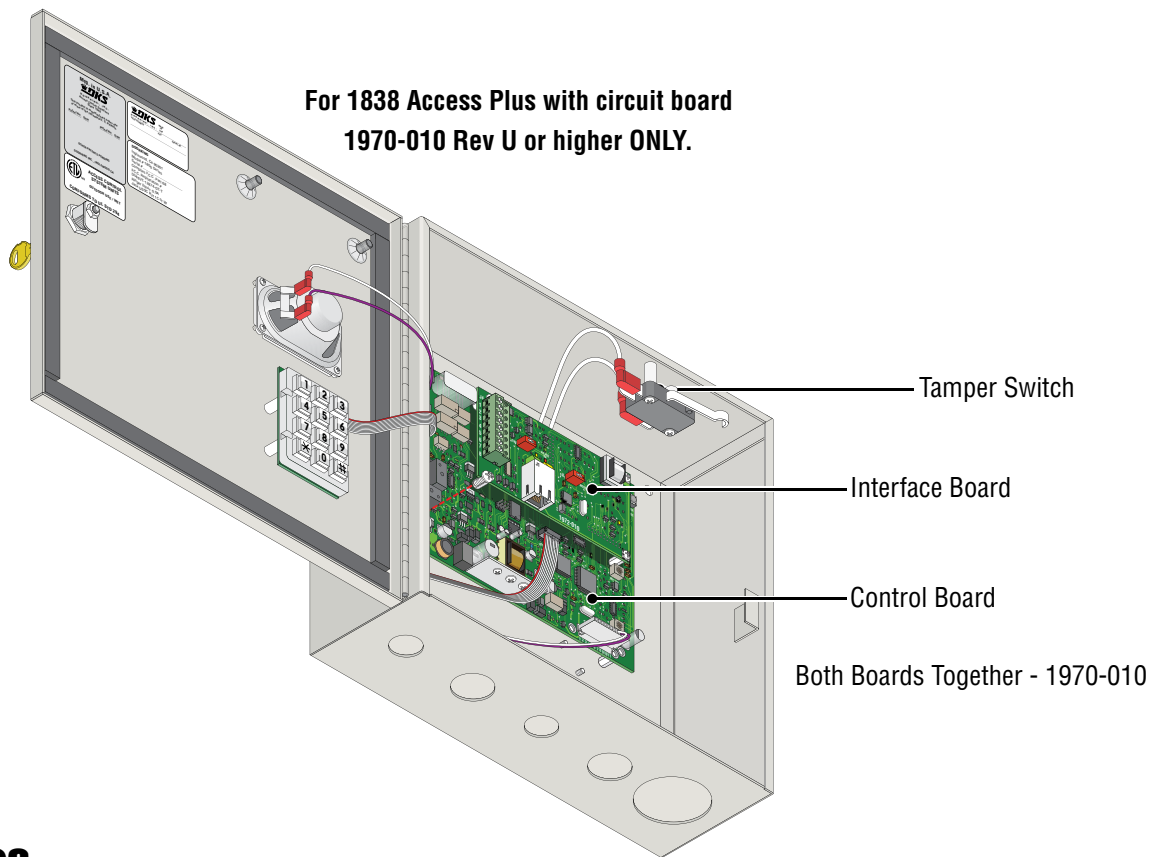

Features

- IP Addressable – the 1838 Access Plus can be programmed from your PC using the DoorKing programming software via a LAN or WAN connection. It can also be programmed via the built-in modem (Central Office phone line required).
- The 1838 is an access controller that can control up to six (6) entry points via card, keypad or RF devices using RS-485 communication protocol. In addition, two (2) additional auxiliary relays are built into the system and are time zone controlled. These relays can be utilized to unlock or open a door or gate at preprogrammed times.
- 100 card / transmitter / keypad codes.
- Holiday schedule.
- 500 event transaction buffer.
- Built-in clock / calendar.
- Four hold-open time zones.
- Entry code time zones.

**Included with the system is an extra random keyed cabinet lock. If desired, for added security against unauthorized entry into the system, the standard lock may be replaced with the random lock.
Note: DoorKing cannot replace this specific lock or keys if lost.**

TABLE OF CONTENTS

Quick Guide: Terminals and LED Descriptions	Quick Guide - 1
Quick Reference Table	Quick Guide - 2
SPECIFICATIONS	Previous Page
Important Notices FCC - United States, DOC - Canada	3
Glossary	3
General Information Installation Guidelines and Safety Information	4
SECTION 1 - INSTALLATION	5
1.1 Remove the Control Board	5
1.2 Install Enclosure	6
1.3 Mounting Dimensions	7
1.4 16.5 VAC Power Wiring ONLY!	8
1.5 Grounding and Surge Suppression	8
1.6 "OPTIONAL" Telephone Line Wire	9
1.7 Wire 1838 to "OPTIONAL" Telco Line	10
1.8 Main Terminal Description	11
1.9 1838 Interface Board	11
1.9.1 RS-485 8-Pin Connector Description	11
RS-485 Daisy Chain Wiring	12
RS-485 Configurations	13
1.9.2 Network Connections	14-15
1.9.3 Phone Modem Connection	16
1.10 UL 294 Compliant Tamper Switch	17
SECTION 2 - PROGRAMMING	18
2.1 Programming the Master Code	18
2.2 Programming Methods	19
2.3 Programming the Network Setup for a Computer	20
2.3.1 Set the 1838 IP Address (reboot required)	20
2.3.2 Sub-Net Mask (reboot required)	20
2.3.3 Set the Gateway (Router) IP Address (reboot required)	21
2.3.4 Set the Port Number (reboot required)	21
2.3.5 Enable / Disable TCP / IP Support - System Reboot	21
2.4 System Parameters Programming	22
Programming from the System Keypad	22
Programming from a Touch-Tone Telephone	22
Quick Reference Table	23
2.4.7 Relay Strike Time	24
2.4.8 Tone Open Numbers	24
2.4.9 Answer Incoming Call on X Rings	24
2.6 Access Codes to Operate Access Control Devices	25
2.6.4 Device Access Code Programming "Time Zone Restricted"	25
2.6.5 Delete a Device Access Code	25
2.6.6 Delete All Device Access Codes for the Same Type of Device	25

TABLE OF CONTENTS

2.7 Time Functions	26
2.7.1 Time and Date Calendar Chip Programming	26
2.7.5 Automatic Relay Activation Time Zone Programming (Up to 4)	26
2.7.6 Access Code Time Zone Programming (Up to 4)	27
2.8 Miscellaneous	27
2.8.1 Restore Factory Settings	27
2.8.2 Erase Transaction Log	27
SECTION 3 - USER INSTRUCTIONS	28
Interface Board LED Status	28
System Keypad	28
3.1 Remote Touch-Tone Phone Operation	29
3.2.1 Remote Programming	29
3.2.2 Remote Relay Activation	29
SECTION 4 - MAINTENANCE	29
4.1 Troubleshooting	29
4.2 Troubleshooting Table	30
4.3 1838 Access Plus Wiring Schematic	31
4.4 Accessories	32
4.5 Programmed Information Log Sheets	33-35
Master Code, Relays, Access Codes and Time Zone Log Sheets; Access Code Log Sheets	

Important Notices

FCC – United States

This equipment has been tested and found to comply with the limits for a class A digital device, pursuant to Part 15 of the FCC Rules and Regulations. These limits are designed to provide reasonable protection against harmful interference when the equipment is operated in a commercial environment. This equipment generates, uses, and can radiate radio frequency energy and, if not installed and used in accordance with the instruction manual, may cause harmful interference to radio communications. Operation of this equipment in a residential area is likely to cause harmful interference in which case the user will be required to correct the interference at his own expense.

FCC Registration Number: **DUF6VT-12874-0T-T**

DOC - Canada

The Canadian Department of Communications label identifies certified equipment. This certification means that the equipment meets certain telecommunications network protective, operational, and safety requirements. The Department does not guarantee the equipment will operate to the users satisfaction.

Before installing this equipment, users should ensure that it is permissible to be connected to the facilities of the local telecommunications company. The equipment must also be installed using an acceptable means of connection. The customer should be aware that compliance with the above conditions may not prevent degradation of service in some situations.

Repairs to certified equipment should be made by an authorized Canadian maintenance facility designated by the supplier. Any repairs or alterations made by the user to this equipment, or equipment malfunctions, may give the telecommunications company cause to request the user to disconnect the equipment.

Users should ensure, for their own protection, that the electrical ground connections of the power utility, telephone lines, and internal metallic water pipe system, if present, are connected together. This precaution may be particularly important in rural areas. CAUTION: Users should not attempt to make such connections themselves, but should contact the appropriate electric inspection authority, or electrician, as appropriate. DOC Registration Number: **1736 4507 A**

Notice:

The Load Number (LN) assigned to each terminal device denotes the percentage of the total load to be connected to a telephone loop which is used by the device, to prevent overloading. The termination on a loop may consist of any combination of devices subject only to the requirement that the sum of the load numbers of all the devices does not exceed 100.

Notice:

DoorKing does not provide a power transformer on units sold into Canada. Use only transformers that are CSA listed to power the telephone entry system. The Access Plus system requires a 16.5-volt, 20 VA transformer.

Listing:

This product has been tested to and found to be in compliance with the UL 294 Safety Standard and Certified to CAN/ULC-S319-05 by Intertek Testing Services NA Inc. (a Nationally Recognized Testing Laboratory) and is ETL listed.

Performance Levels	Destructive Attack:	Level I
	Line Security:	Level I
	Endurance:	Level IV
	Standby Power:	Level I (Level II with 12 VDC, .7 Ah, SLA battery,
	Single Point Locking Device with Key Locks:	Level I required for Canadian certification)

Glossary

ACCESS CONTROL SYSTEM: A collection of means, measures and specific practices that when combined, form or compose a systematic approach, which enables an authority to control access to areas and resources in a given physical facility. An access control system, within the field of physical security, is generally seen as the second layer in the security of a physical structure.

ALARM: A condition indicating a state of alert or tamper detection.

ALARM SIGNAL: A transmission of an alarm condition or alarm report.

CONTROLLED AREA: A room, office, building, facility, premises, or grounds to which access is monitored, limited, or controlled.

EQUIPMENT: Any part of an electronic access control system, such as access control units, reader interface modules, access point actuators, access point sensors, keypads, and the like.

PROTECTED AREA: A room, office, building, facility, premise or grounds to which access is monitored, and limited and/or controlled, whereby the authorized person of the Access Control System may grant access to non-authorized persons.

RESTRICTED AREA: A room, office, building, facility, premise or grounds to which access is monitored, and limited and strictly controlled, whereby only the administrator of the Access Control System shall issue credentials that will lead to access.

General Information

- Prior to beginning the installation of the telephone entry system, we suggest that you become familiar with the instructions, illustrations, and wiring guidelines in this manual. This will help insure that you installation is performed in an efficient and professional manner.
- The proper installation of the telephone entry panel is an extremely important and integral part of the overall access control system. Check all local building ordinances and building codes prior to installing this system. Be sure your installation is in compliance with local codes.
- When used to control a door or pedestrian gate, try to locate the telephone entry system as near as possible to the entry point. The unit should be mounted on a rigid wall to prevent excessive shock and vibration from closing doors or gates. Continuous vibration and shock from slamming doors or spring-loaded pedestrian gates will damage the circuit board. **Under no circumstances should the unit be mounted directly to a moving door or gate.**
- **ADA mounting requirements for door control (Ref: ICC/ANSI A117.1-2009).** The requirements below apply **ONLY** when the telephone entry system is being used to control entry through **A PUBLIC DOOR ONLY**. If this system is used to control entry through a **vehicular gate** or **private entrance**, the dimensions noted below **do not apply**.

1. Unobstructed Forward Reach. Where a clear floor or ground space allows only a forward approach to an object and is **unobstructed**, mounting height shall be a minimum of **15 inches** (381 mm), and a maximum of **48 inches** (1.22 m), above the floor or ground to the operable controls.

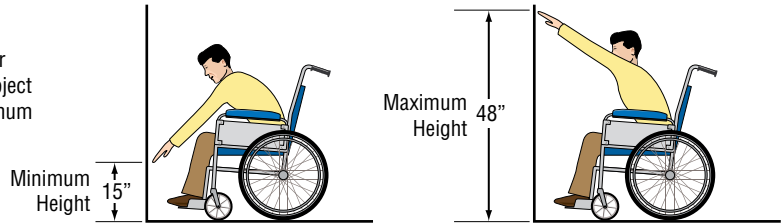

2. OBSTRUCTED HIGH Forward Reach. If the high forward reach is over an obstruction, reach and clearances shall be as shown. **NOTE: If the height of a control is 48" maximum, then the length of the obstruction must be 20" or less. If the height of a control is 44" maximum, then the length of the obstruction may be increased to 25" or less.**

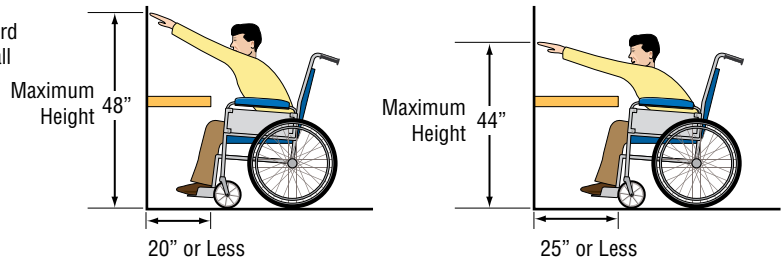

3. Unobstructed Side Reach. Where a clear floor or ground space allows a parallel approach to an object and the side reach is **unobstructed**, and the edge of the clear floor space is **10 inches** (255 mm) maximum from the object, mounting height shall be a minimum of **15 inches** (380 mm), and a maximum of **48 inches** (1.22 m), above the floor or ground to the operable controls.

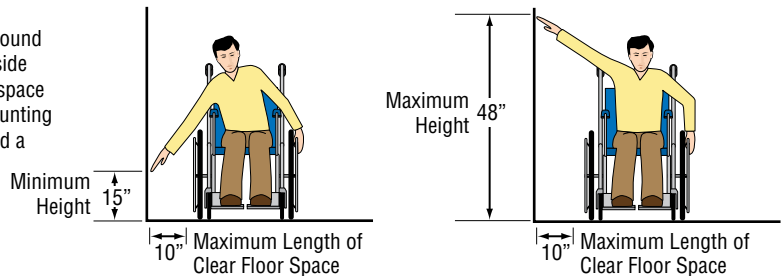

4. OBSTRUCTED HIGH Side Reach. If the side reach is over an obstruction **10 inches or less**, mounting height shall be a maximum of **48 inches** (1.21 m) above the floor or ground to the operable controls. If the side reach is over an obstruction **greater than 10 inches, but less than 24 inches**, mounting height shall be a maximum of **46 inches** (1.17 m) above the floor or ground to the operable controls.

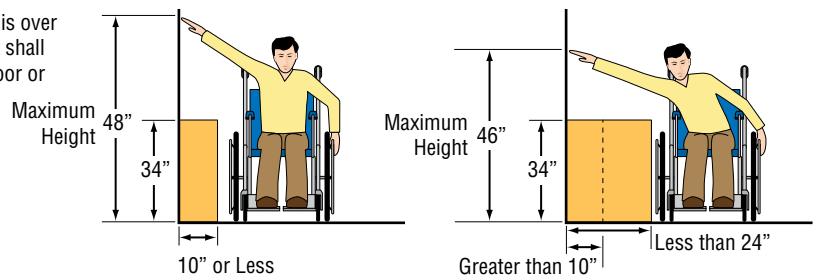

- **When used to control a vehicular gate with an automatic gate operator, the telephone entry system must be mounted a minimum of six (6) feet away from the gate and gate operator, or in such a way that a person cannot operate the entry system and/or touch the gate or gate operator at the same time.**
- Be sure that the system is installed so that it is not directly in the traffic lane. Goose neck mounting post and kiosks work well for these type systems. When planning where to locate the system, take into consideration traffic lane layouts, turn around lanes for rejected access, conduit runs, power availability, etc.
- Environmental factors must also be taken into account. Units are designed for direct outdoor installations, however it is preferable to protect them from direct exposure to driven rain or snow whenever possible.
- This telephone entry system contains a number of static sensitive components that can be damaged or destroyed by static discharges during installation or use. Discharge any static prior to removing the circuit board from the lobby panel by touching a proper ground device.
- **Instruct the end user to read and follow these instructions. Instruct the end user to never let children play with or operate any access control device. This Owner's Manual is the property of the end user and must be left with them when installation is complete.**

SECTION 1 - INSTALLATION

Installation of the Access Plus Access Control System involves the installation of the hardware and the wiring of these components. Be sure that all dirt, metal or wood debris is removed from inside after mounting it. Any debris inside could damage the control board and cause the 1838 to malfunction during operation.



WARNING

When the 1838 is used to control a vehicular gate with an automatic gate operator, it must be mounted a minimum of six (6) feet away from the gate and gate operator, or in such a way that a person cannot operate the 1838 and/or touch the gate or gate operator at the same time.

Included with the system is an extra random keyed cabinet lock. If desired, for added security against unauthorized entry into the system, the standard lock may be replaced with the random lock. Note: DoorKing cannot replace this specific lock or keys if lost.

1.1 Remove Control Board

CAUTION The control board contains static sensitive components. Discharge any static electricity from your hands by touching a proper ground device **before** removing the control board.

1. Unlock and open the door.
2. Disconnect the keypad plug and door accessories plug from the control board.

3. Remove the 4 screws from board.
Carefully remove control board.

Keep the control board in a protected area during the mounting installation.

4. Mount enclosure, see next page for specific mounting of the 1838 enclosure.

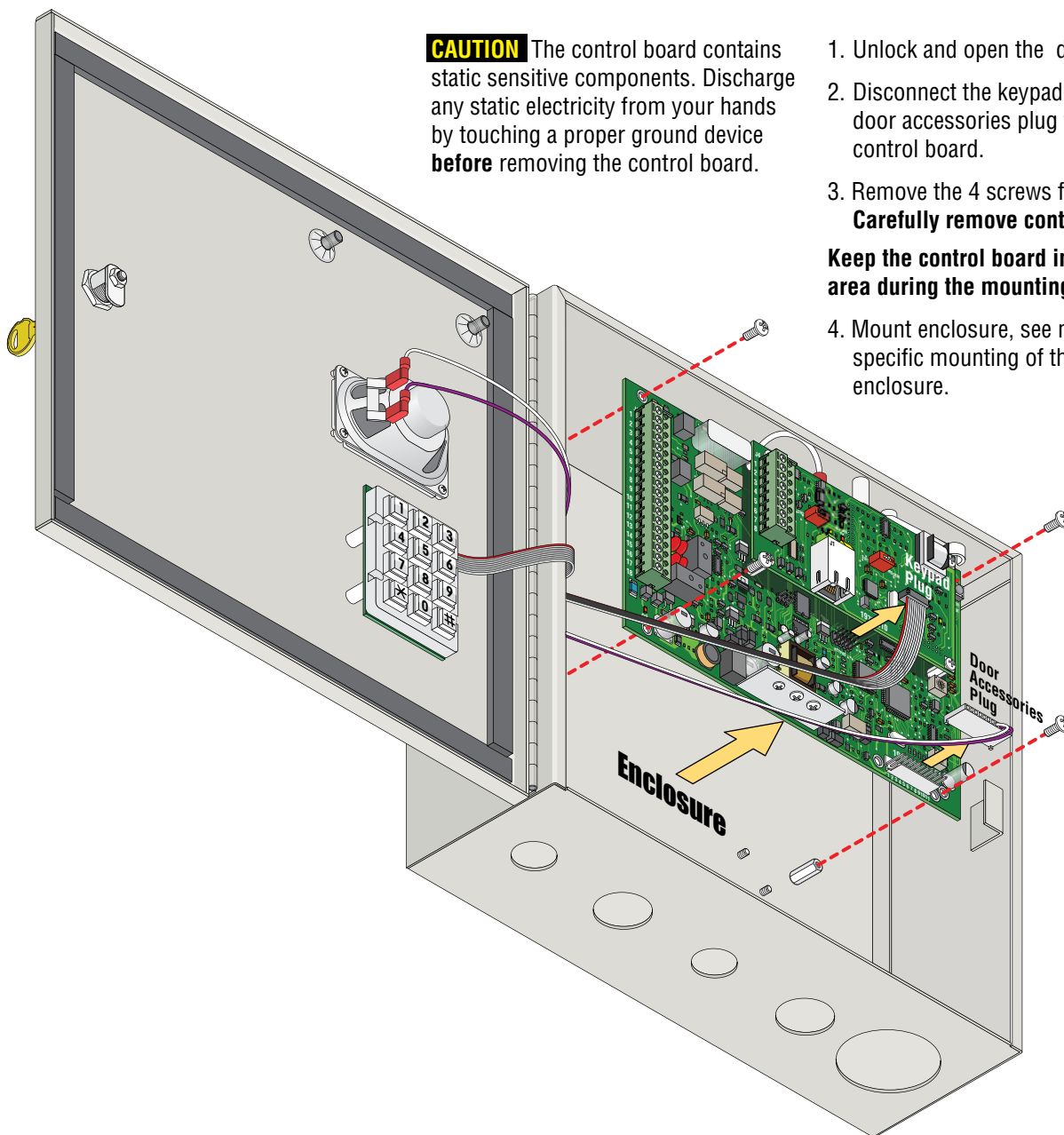

1.2 Install Enclosure

1. Mount the enclosure using the mounting holes provided in the corners (see section 1.3 for dimensions). Be sure that mounting screws (Not supplied) do not protrude into the enclosure where they could cause a short on the back of the circuit board. Make any necessary conduit connections through the bottom of the enclosure using the existing conduit knock-outs. **DO NOT** make any new conduit holes in the enclosure.
2. Route all wiring through conduit into enclosure.
3. Clean out the enclosure. Make sure that all dirt, metal and/or wood debris is removed.
4. Re-install circuit board back into the enclosure (Reverse section 1.1 steps). Use the wiring schematics in the back of this manual to help re-install the circuit board if necessary. **DO NOT** apply any power at this time.

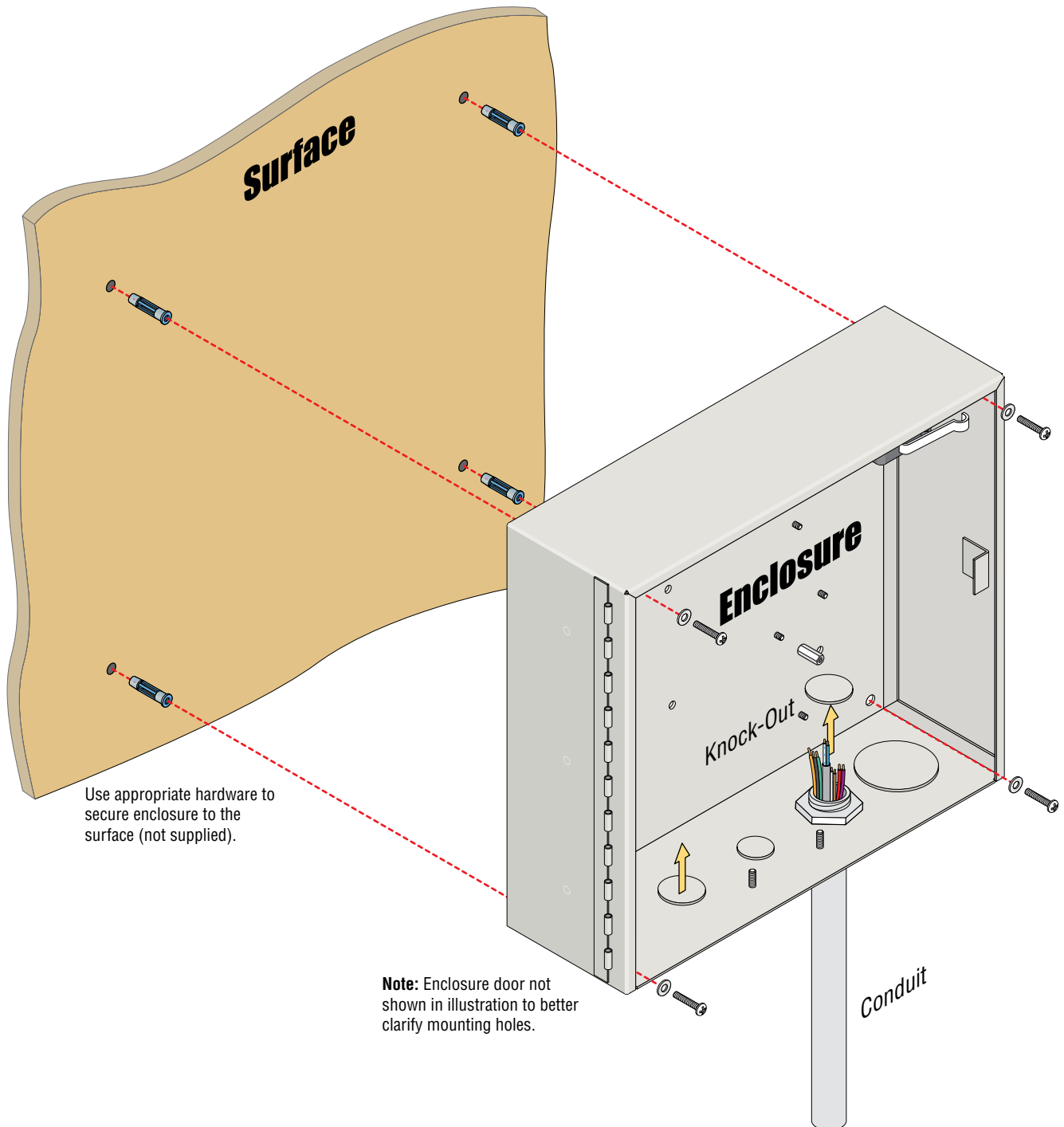

1.3 Mounting Dimensions

If used to control a door or pedestrian gate, try to locate the access controller as close as possible to the entry point. The unit should be mounted on a rigid wall to prevent excessive shock and vibration from closing doors or gates. Continuous vibration and shock from slamming doors or spring-loaded pedestrian gates will damage the circuit board. **Under no circumstances should the unit be mounted directly to a moving door or gate.**



DoorKing recommends replacing the Standard Key Lock with the "Random" Key Lock that is included.

Back View

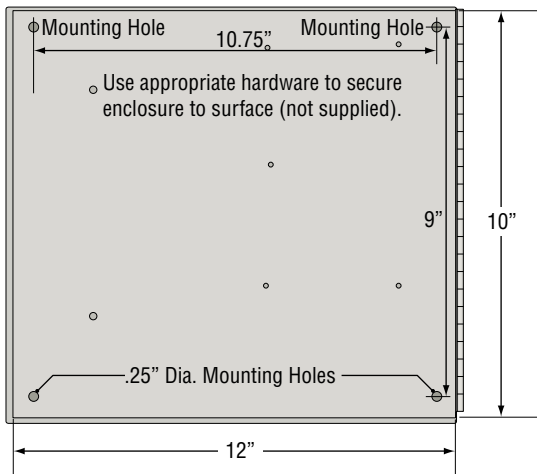

Side View

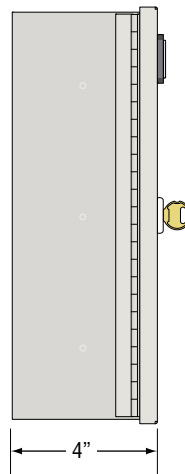

Front View

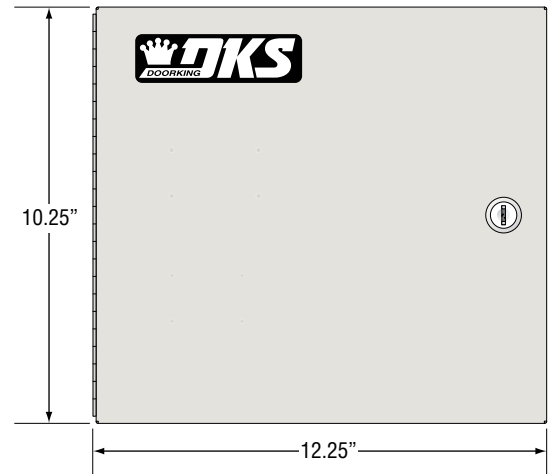

WARNING! If the 1838 is used to control a vehicular gate with an automatic gate operator, the entry system must be mounted a minimum of six (6) feet away from the gate and gate operator, or in such a way that a person cannot operate the entry system and touch the gate or gate operator at the same time.

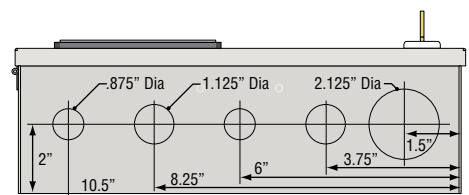

Bottom View

1.4 16.5 VAC Power Wiring ONLY!

The 1838 operates **ONLY** on 16.5 VAC. **DO NOT** power the unit with 24 volt AC power. Use the supplied power transformer, 16 VAC, 20 VA (or U.L. listed equivalent) to power the system. **DO NOT** power any other devices (electric strikes, magnetic locks, etc.) from the unit's power transformer. See table below for wire run distances.

Power Transformer Wire Run Table

Wire Size	Max Distance
18 AWG	100 ft
16 AWG	200 ft

⚠ CAUTION

DO NOT power the unit from a 24-Volt source (Such as a gate operator). **Damage will occur to the unit that is NOT** covered under DoorKing's warranty.

OV Over Voltage Power Note: LED located on bottom left corner of board will light up if too much power is applied to circuit board.

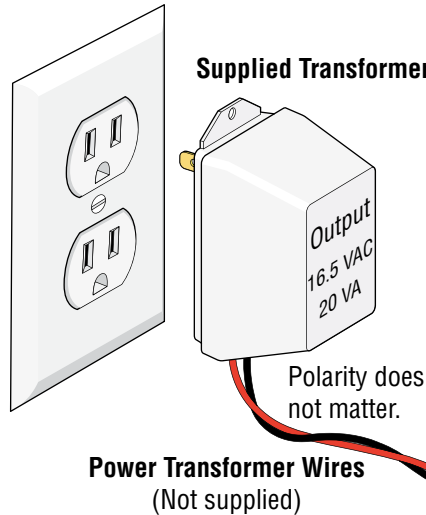

Do Not Connect To A Receptacle Controlled By A Switch.

Power Interruption Note: The Time and Date calendar chip (Section 2, 2.7.1) in the 1838 will keep time for approximately 48 hours if power to the system is lost or removed. If power is off **longer** than this, the **Time and Date will need to be reprogrammed into the system.** All other specific programming that has been done will remain intact after power has been restored.

DoorKing offers a **12 volt .8 amp hour gel cell battery** that can connect to the main terminals 9 and 10 to provide standby power during power interruptions. (DoorKing P/N 1801-008)

1.5 Grounding and Surge Suppression

Proper Grounding and the use of surge suppressors can significantly reduce the chance of component failure because of static charges or surges. To be effective, ground connections should be made with a minimum 12 AWG wire to a ground point within 10 feet of the device being protected. The ground point can be at an electrical panel, a metallic cold water pipe that runs in the earth or a grounding rod driven at least 10 feet into the soil. **A gooseneck mounting post anchored in concrete does NOT make a good ground.**

Some Acceptable Ground Sources

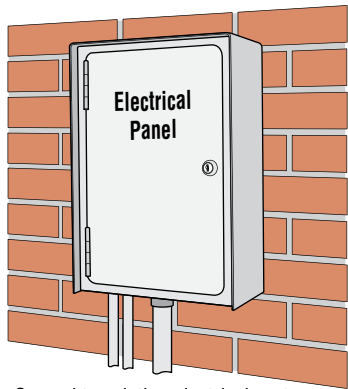

Ground to existing electrical system.

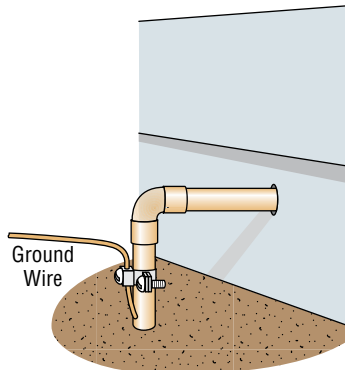

Ground to metallic cold water pipe.

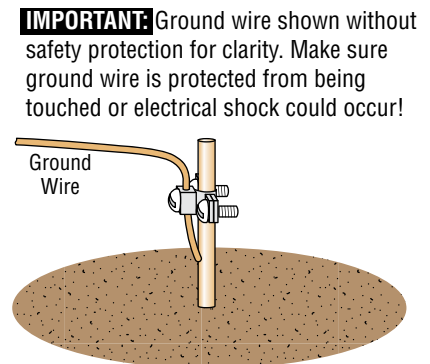

Grounding rod 10 feet in soil.

IMPORTANT: Ground wire shown without safety protection for clarity. Make sure ground wire is protected from being touched or electrical shock could occur!

Telephone Line Surge Suppressor

It is highly recommended that telephone line surge suppressor (DoorKing P/N 1877-010) be installed to help protect the system from phone line power surges. Surge suppressor must be positioned 3 ft or less from the ground source, 12 AWG min.

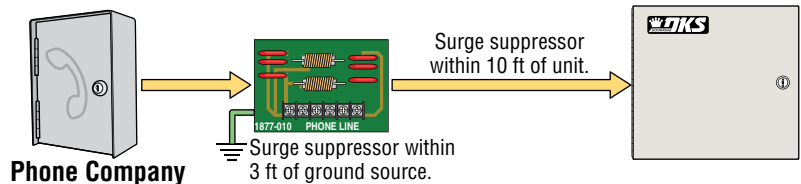

Low Voltage Surge Suppressor

It is highly recommended that a low voltage surge suppressor (DoorKing P/N 1878-010) be installed to help protect the telephone entry system from power surges. Surge suppressor must be positioned 3 ft or less from the ground source, 12 AWG min.

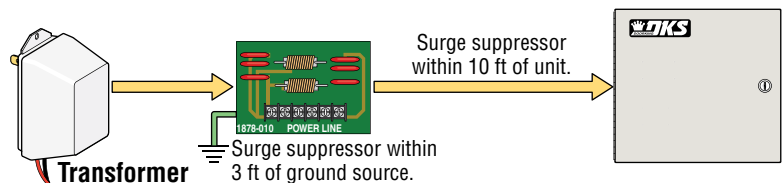

1.6 “OPTIONAL” Telephone Line Wire

Be sure to observe electrical safety when working with phone lines. Phone lines carry electricity and the ring voltage can deliver a substantial jolt.

In most older residences and buildings, the phone cable contains four wires; green, red, black, yellow. The green and red are twisted to make one pair and the black and yellow are twisted to make another pair (This allowed for the addition of a second phone line since telephones use only two wires). Most phone lines installed in the U.S. in the second half of the 20th Century have this type of wire. This type of wire is now obsolete. All new telephone projects are using Cat5 wire. If you have Cat5 wiring in your residence, the conversion is simple:

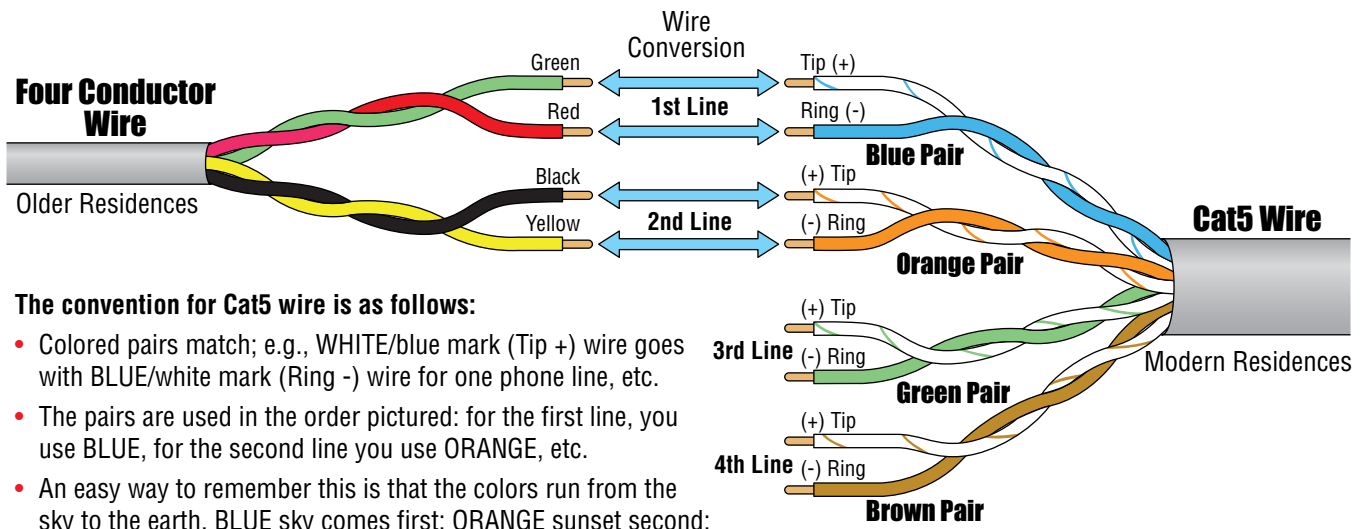

The convention for Cat5 wire is as follows:

- Colored pairs match; e.g., WHITE/blue mark (Tip +) wire goes with BLUE/white mark (Ring -) wire for one phone line, etc.
- The pairs are used in the order pictured: for the first line, you use BLUE, for the second line you use ORANGE, etc.
- An easy way to remember this is that the colors run from the sky to the earth. BLUE sky comes first; ORANGE sunset second; GREEN grass third; BROWN earth last.

“Tip” and “Ring” Definition. Common terms in the telephone service industry referring to the two wires or sides of an ordinary telephone line. Tip is the ground side (positive) and Ring is the battery (negative) side of a phone circuit. The ground side is common with the central office of the telephone company (telco); the battery side carries -48 volts of DC voltage when in an “Idle” or “On Hook” state.

Phone Line Polarity. Tip and ring reversal is mostly immaterial, except for special circuits including DID (Direct Inward Dialing) trunks, T-1 lines, and ground start lines where the field side (“terminal”) equipment (a company’s PBX switch, for example) can only function correctly with correct tip and ring polarity.

Wire Type. It is extremely important to use the correct type of wire in telephone applications. Since the Access Plus system requires phone lines to be run outdoors or in an underground environment, **we recommend that you use only wire that is rated for direct underground burial.** For example, use **Cat5e Gel Filled (flooded) UV Resistant Direct Burial Cable run in conduit for your Access Plus system phone line requirements.** Do not use thinly insulated brown-jacketed telephone wire (the type found in the walls of a structure) for outdoor or underground phone line wiring. Using **improper wire can cause noise and hum** on the phone line. Be sure that phone wire pairs are twisted.

Wire Size and Distance. Phone lines can be run up to 3600 feet, provided that the proper wire size is used.

Wire Size	Max Distance
24 AWG	800 ft
22 AWG	1600 ft
20 AWG	2200 ft
18 AWG	3600 ft

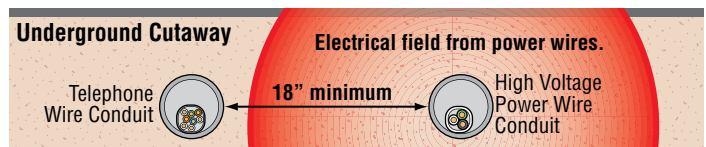

Note: Do not run telephone wires and high voltage power wires in the same conduit. Separate the high voltage conduit and the telephone conduit by at least 18 inches to prevent any electrical field interference that could occur.

1.7 Wire 1838 to "OPTIONAL" Telco Line

If the 1838 will be programmed from your computer using a **Phone modem** or programmed and/or relay activation from a **remote touch-tone telephone**, a dedicated telephone line **MUST** be connected to the 1838. **Note:** All 1838 RJ-45 jack connections (direct or internet) to program the unit **DO NOT** use a "Telco" telephone line.

⚠️ Connect to Incoming Telephone Company's Phone Line

Locate the telephone company demarcation device.

IMPORTANT! Identify the telephone line that will connect to the Access Plus unit and wire as shown.

Use only twisted pair telephone wire that is rated for direct underground burial. **DO NOT** use wire that is intended for indoor applications. Recommend Cat5e Gel Filled (flooded) UV Resistant Direct Burial Cable in conduit. **DO NOT** run telephone wires and high voltage wires in the same conduit. For complete info, see section 1.6.

Telephone Company Demarcation Point

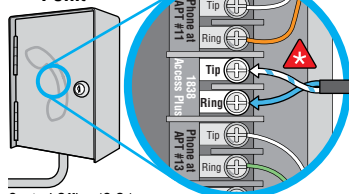

Central Office (C.O.) Demarcation Device

Locate unit's Phone Line Inside Device

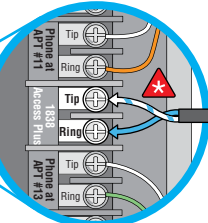

TIP (+): White/blue mark
RING (-): Blue/white mark

Telco

Access Control Devices



"Normally Open" Vehicular Gate Operator

Use minimum 18 AWG wire for runs up to 100 feet. 16 AWG wire for runs up to 200 feet. (Term. 11 and 13)

Pedestrian Gate/Door

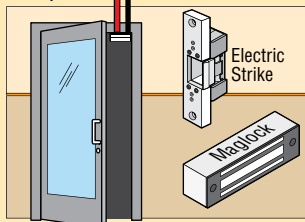

"Normally Close" with Maglock (Terminal 15 and 16)

"Normally Open" with Electric Strike (Terminal 14 and 16)
Magnetic locks or electric strikes must be powered from a separate UL Listed power transformer. **DO NOT** power strikes or magnetic locks from the unit's power transformer. Use minimum 18 AWG wire for runs up to 100 feet; 16 AWG wire for runs up to 200 feet. It is recommended to keep power wire runs as short as possible.

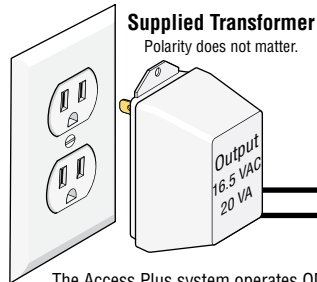

The Access Plus system operates **ONLY** on 16.5 VAC. **DO NOT** power the unit with 24 Volt transformer or source voltage. Use the supplied power transformer, 16.5 VAC, 20 VA (or UL listed equivalent) to power the telephone entry system. **DO NOT** power any other devices (electric strikes, magnetic locks, additional units etc.) from the unit's power transformer. See section 1.4 for wire size and run distances.

Do Not Connect To A Receptacle Controlled By A Switch.

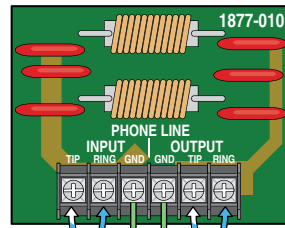

Optional Phone Line Surge Suppressor

DoorKing Surge Suppressor P/N 1877-010 (or equivalent) is optional but highly recommended. For best protection, surge suppressor ground wire **MUST** be 3-ft. or less in length. Use minimum 12 AWG wire. Refer to instruction sheet included with surge board and section 1.5 for complete information.

Telephone Line (Twisted Pair)

For complete info, see section 1.6.

Be sure to properly ground ALL boards. See section 1.5 for acceptable grounding sources.

⚠️ Check Polarity of Telephone Line

Check for polarity on the phone "IN" wires, terminals 1 and 2. Terminal 2 must be positive with respect to terminal 1. Set a VOM meter to measure DC volts. Place the positive lead on terminal 2 and the negative lead on terminal 1. If the meter shows a positive voltage - OK. If the meter shows a negative voltage (needle moves off scale to the left), reverse the wires on terminals 1 and 2.

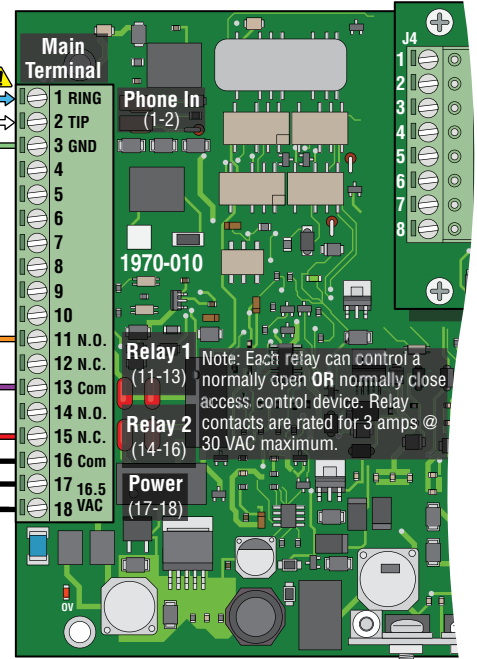

1838 Circuit Board

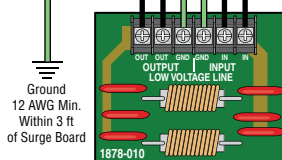

Optional Low Voltage Surge Suppressor

DoorKing Surge Suppressor P/N 1878-010 (or equivalent) is optional but highly recommended. For best protection, surge suppressor ground wire **MUST** be 3-ft. or less in length. Use minimum 12 AWG wire. Refer to instruction sheet included with surge board for complete information.

1.8 Main Terminal Description

- | | | | |
|---|-----|---|--|
| Phone In
(Twisted Pair) | 1. | Phone In (Negative - Ring) | (Optional - Phone modem programming or remote touch-tone phone control only) |
| | 2. | Phone In (Positive - Tip) | |
| | 3. | Ground (Required) | |
| | 4. | Not Used | |
| | 5. | Not Used | |
| | 6. | Not Used | |
| Emergency and/or Postal Entry Switch | 7. | Switch Input Relay 1. A switch closure across terminals 7 & 9 will activate relay 1 for its programmed strike time. | |
| | 8. | Switch Input Relay 2. A switch closure across terminals 8 & 9 will activate relay 2 for its programmed strike time. | |
| Optional Standby Battery Power | 9. | - 12 VDC Battery Negative. Also Common for terminals 7 & 8. | |
| | 10. | + 12 VDC Battery Positive (12 VDC, .7 Ah, SLA). | |
| Relay 1
(Access Control Device) | 11. | Relay 1 Normally Open | |
| | 12. | Relay 1 Normally Closed | |
| | 13. | Relay 1 Common | |
| Relay 2
(Access Control Device) | 14. | Relay 2 Normally Open | |
| | 15. | Relay 2 Normally Closed | |
| | 16. | Relay 2 Common | |
| Input Power (Transformer) | 17. | 16.5 VAC Input Power | |
| | 18. | 16.5 VAC Input Power | |

WARNING Maximum input voltage to terminals 9 and 10 is 14.5 Volts DC.

BATT CHARGE LED: When battery is connected to 9 and 10, Green LED will light when charging and turn OFF when charged.

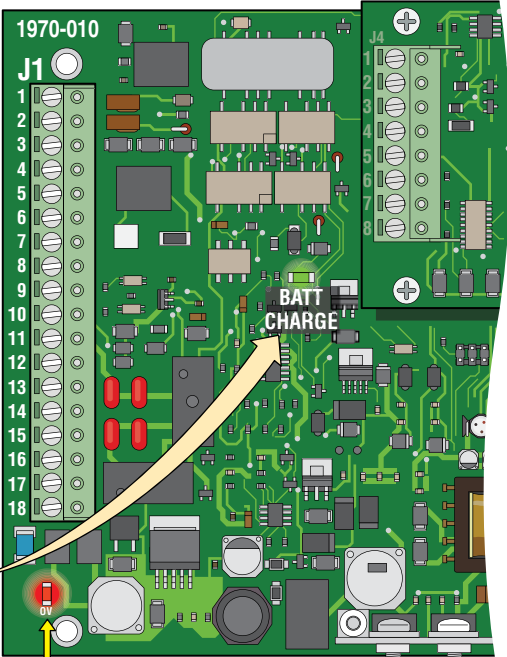

DO NOT use 24V Do Not Connect Power to a Receptacle Controlled by a Switch

Over Voltage Power Note: OV LED will light up if too much power is applied to circuit board.

1.9 1838 Interface Board

The 1838 interface board (1972-010) is piggybacked onto the main unit's Plus circuit board (1970-010). The interface board provides additional connections to the unit for keypads, card readers and/or RF receivers using RS-485 communication protocol.

The 1838 can be programmed via a PC using a network or modem connection. An RJ-45 jack (Cat5) is provided on the interface board for network connections.

1.9.1 RS-485 8-Pin Connector Description

Use the RS-485 terminals to add up to six (6) card readers, keypads and/or RF receivers to the 1838. These devices must be wired in a daisy-chain format with a maximum wire run distance of 4000 feet. We recommend that you use Cat5e wire for all RS-485 wire runs.

DO NOT power RS-485 devices from the 1838. These devices must be supplied with their own power source. Refer to the individual device wiring instructions for connection information and wiring guidelines for these products.

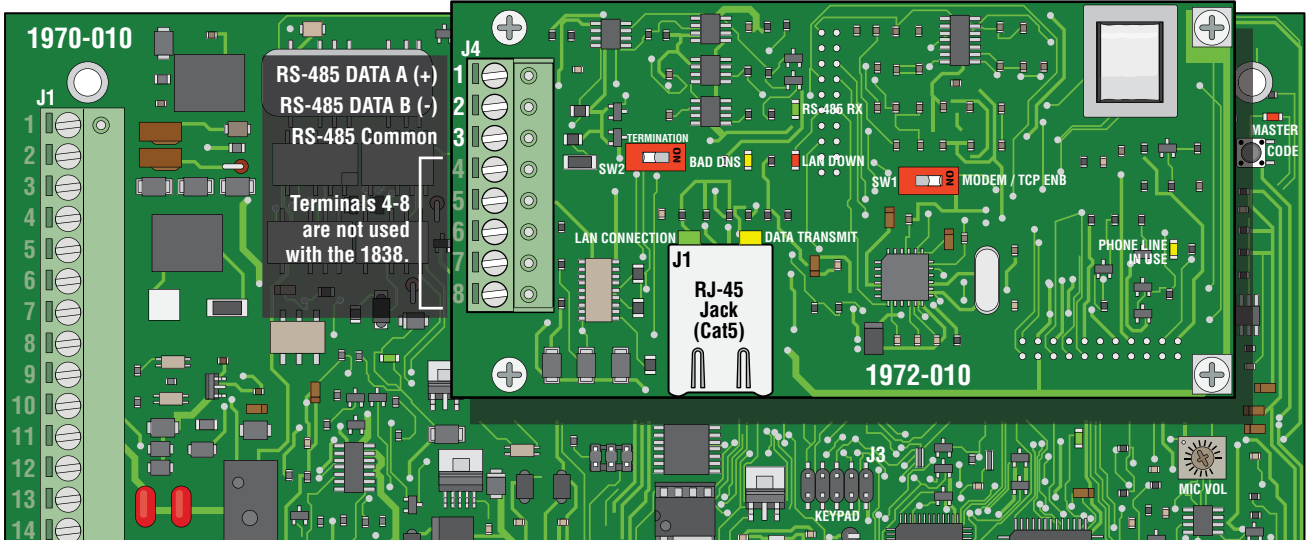

RS-485 Daisy Chain Wiring

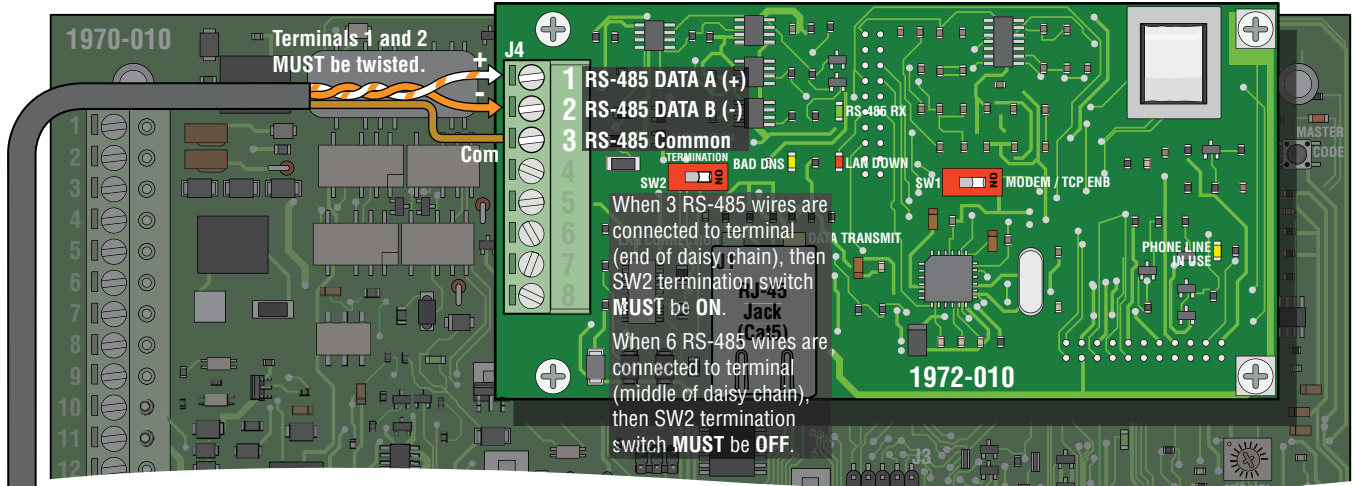

The wires connecting terminals 1 & 2 from the 1838 to terminals 7 & 8 on the DoorKing RS-485 boards MUST be twisted. We recommend that you use Cat5e cable for all the RS-485 connections (See section 1.6 for wire size and run distances table). Use one twisted pair to connect these terminals (terminal 1 connects to RS-485 terminal 8; terminal 2 connects to RS-485 terminal 7) and then one wire from another twisted pair to connect the common terminal (terminal 3 from the 1838 to terminal 6 on the RS-485 board).

Cat5e

RS-485 Cardreader

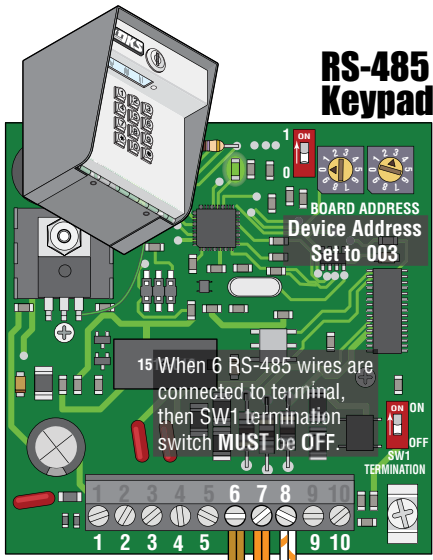
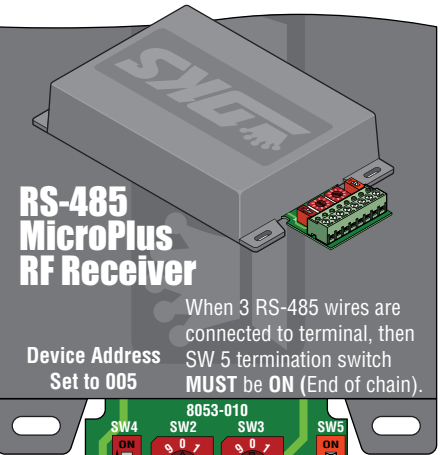
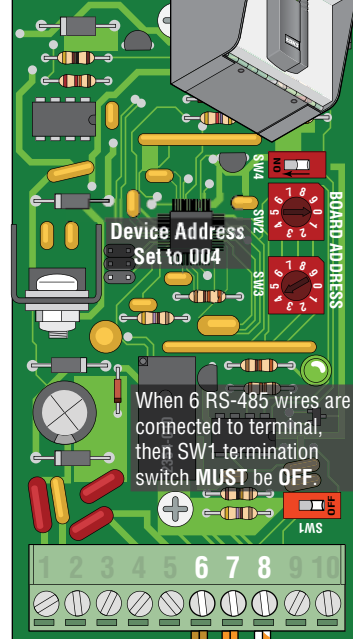

If wiring will be outdoors or underground, use Cat5e Gel Filled (flooded) UV Resistant Direct Burial Cable.

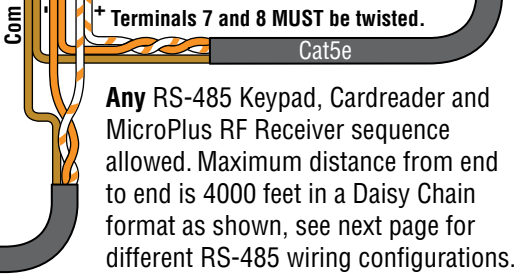

Do Not power RS-485 devices from the 1838. RS-485 devices must be powered from their own power source. Refer to the individual device wiring instructions for connection information and wiring guidelines for these products.

RS-485 Configurations

RS-485 Device Addresses

Every RS-485 device (keypad, card reader, MicroPlus RF receiver) must have a unique address assigned to it, starting with 003. The address selector switches are located on the RS-485 circuit board (see instruction sheets that come with each RS-485 device). The address order of the devices connected to the 1838 does not matter. What is important is that the addresses must be numbered in sequence. **Do not skip a number in the address sequence and start the sequence with 003**

(e.g. If three (3) RS-485 devices are daisy chain wired to the 1838 and their addresses are 003, 004 and 006, this is wrong. They must be addressed 003, 004 and 005).

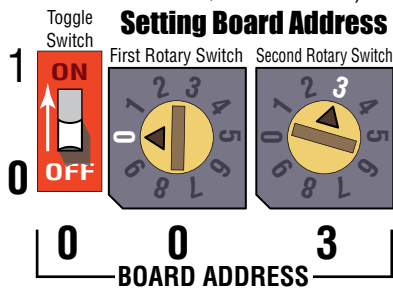

The 2 internal relays on the 1838 circuit board are 001 and 002. **Valid RS-485 external device addresses for use with the 1838 are 003, 004, 005, 006, 007 and 008.**

Important Note: The device address is referred to as a "Relay Number" in the programming software.

Termination Switches

A termination switch is located on **every** circuit board. The termination switch must be **OFF** for every device wired in the middle of the daisy chain. The devices at each end of the daisy chain must have their termination switches **ON**.

Some Configuration Problems to Avoid:

- 1 The total distance for the complete wire run is greater than 4000 ft.
- 2 There are more than 6 RS-485 devices.
- 3 There are more than 2 wire runs coming out of the 1838.
- 4 There are more than 2 end devices terminated and/or incorrect end device terminations (Not turned ON).
- 5 There are more than 6 addresses and/or duplicate or skipped addresses.
- 6 An RS-485 device can not have 2 RS-485 devices separately continued from it.
- 7 The 1838 must have it's SW2 termination switch turned OFF when 2 terminated end devices are being used.

CORRECT Configuration Samples

4000 ft Maximum (3/4 Mile)

The Access Plus system can be wired in the middle of the "Daisy Chain" if needed. It is important that the distance restriction (4000 ft) be observed and that the devices at the end of the chain have their termination switches **ON**. The devices in the middle of the chain have their termination switches turned **OFF**.

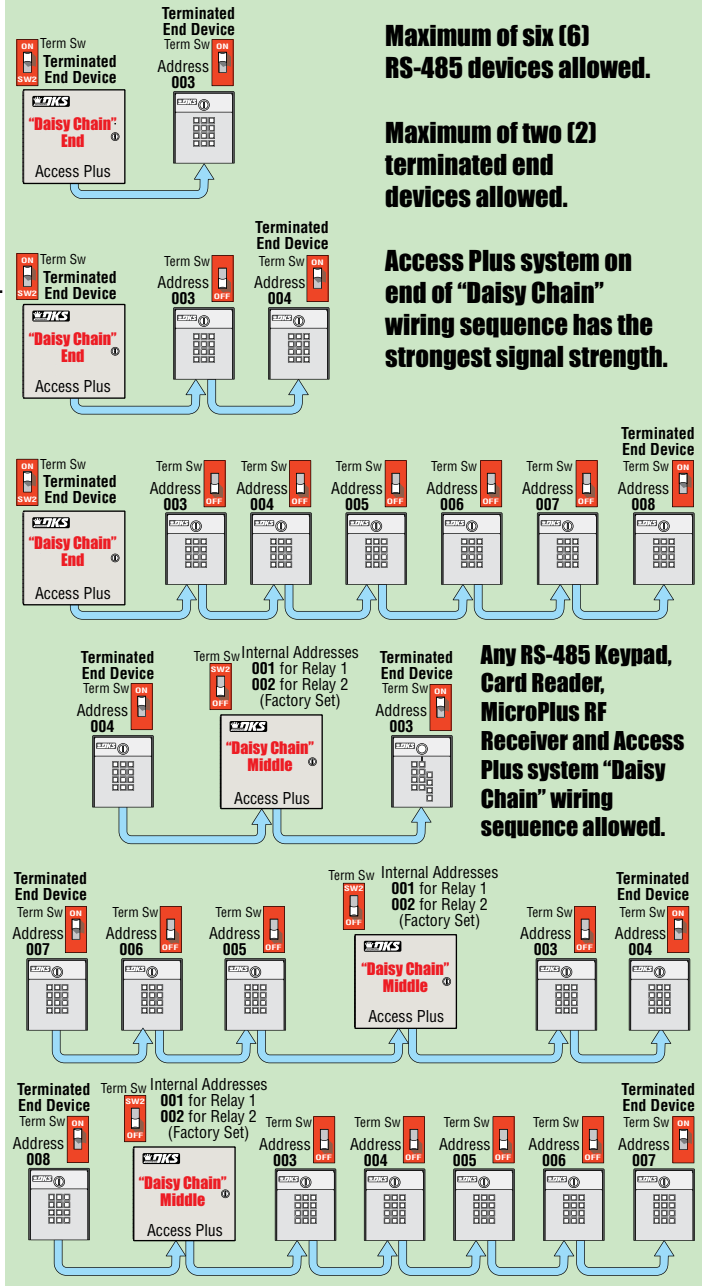

INCORRECT Configuration

4000 ft Maximum (3/4 Mile)

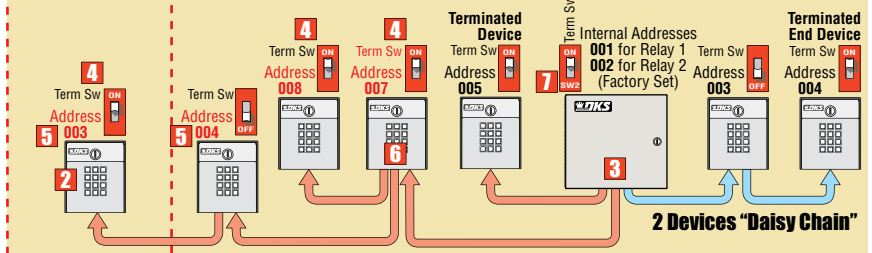

1.9.2 Network Connections

There are a number of ways to communicate with the 1838 via a network connection. Before any programming can be attempted, you need to install the Access Plus programming software on the computer you want to use for this purpose. The computer must have a network card installed. Follow the instructions in the Access Plus programming software help guide and refer to section 2.3 for setup information.

Using a network connection, you can connect to the 1838 in different ways:

Direct Connection Using a Crossover Cable

Locally with a direct connection from the computer to the 1838 using a commercially available crossover cable.

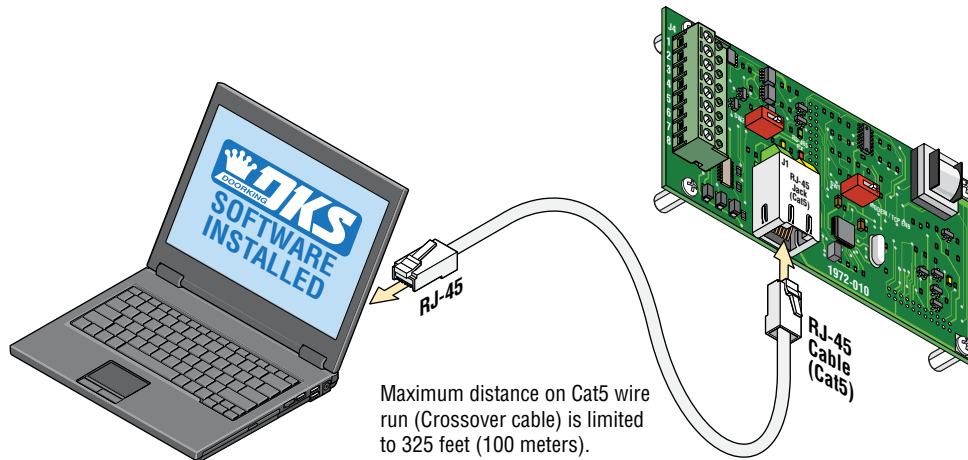

Direct Connection Using a Router (LAN)

Locally by connecting the computer to the 1838 through a router. This is a Local Area Network (LAN) connection.

Note: Router address is set to 192.168.001.001
(See 2.3.3 Set the gateway (router) IP address).

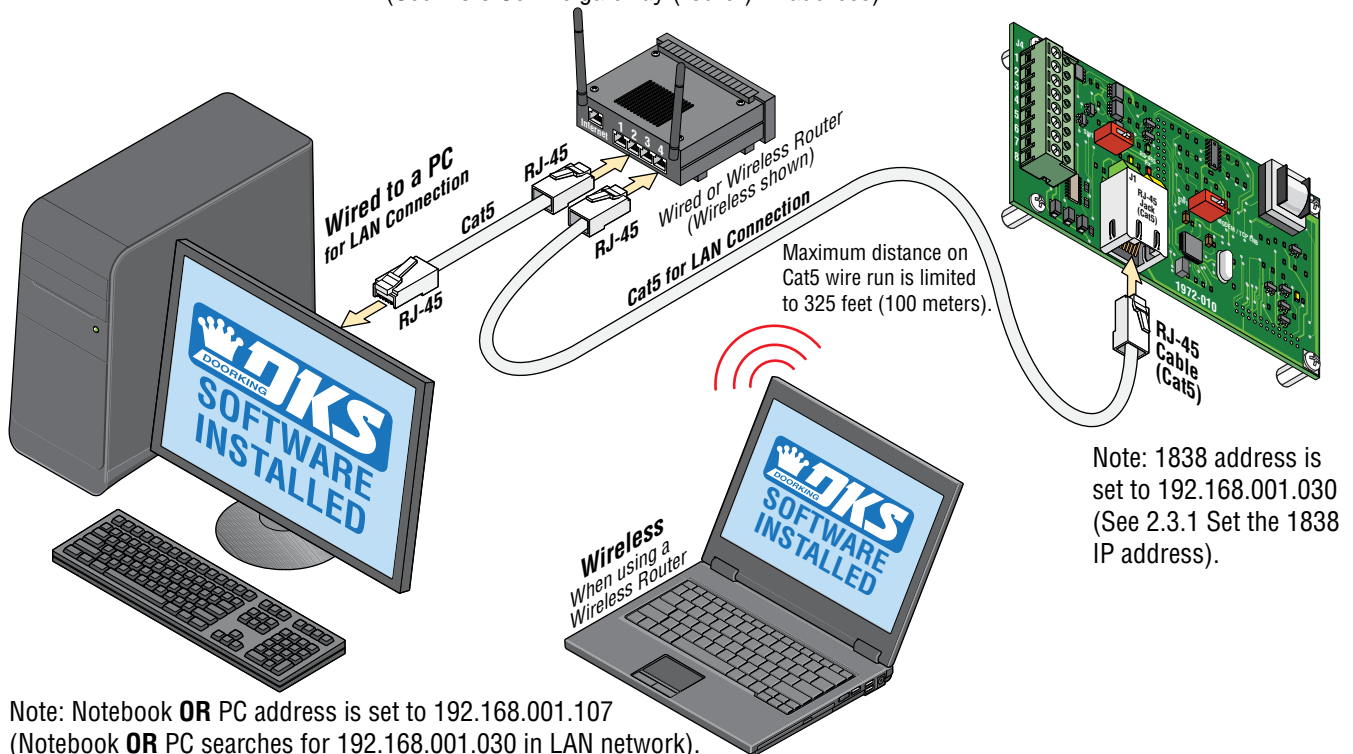

Through the Internet (WAN)

- Through the internet with a **static IP address**. This is a Wide Area Network (WAN) connection and will require a router and a DSL or cable modem with an internet connection.
- Through the internet with a **dynamic IP address**. This is a Wide Area Network (WAN) connection and will require a router and a DSL or cable modem with an internet connection. You will also need a registered DDNS host name.

Note: The gateway address must set into the 1838. This allows the unit to “register” with the LAN 192.168.001.001 (See 2.3.3 Set the gateway (router) IP address).

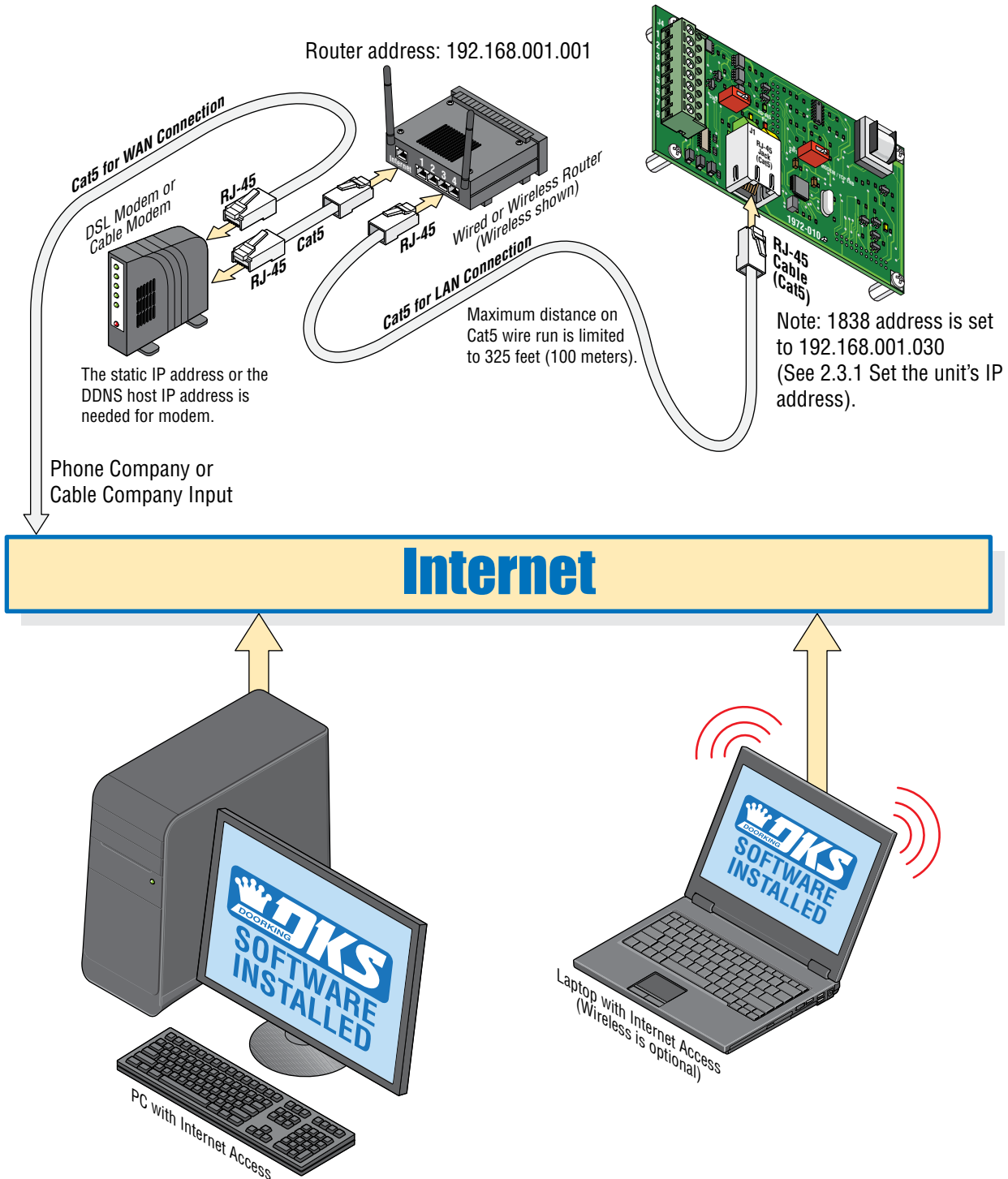

1.9.3 Phone Modem Connection

The 1838 has a **dedicated** phone line. A PC **MUST** be connected to a **separate** phone line to program the 1838.

Phone Modem Connection: 1838 and PC connected on **DIFFERENT** phone lines.

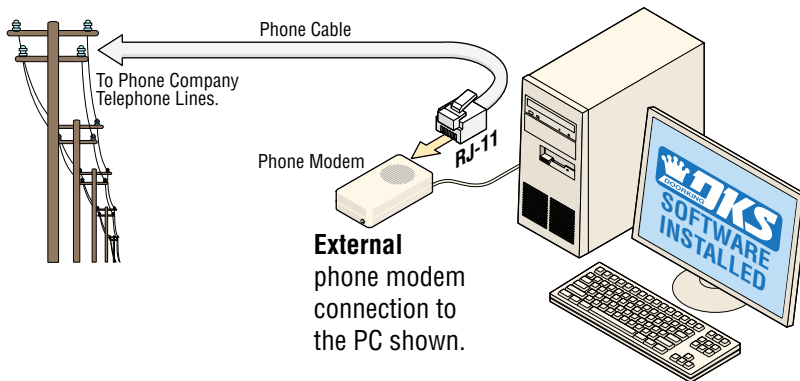
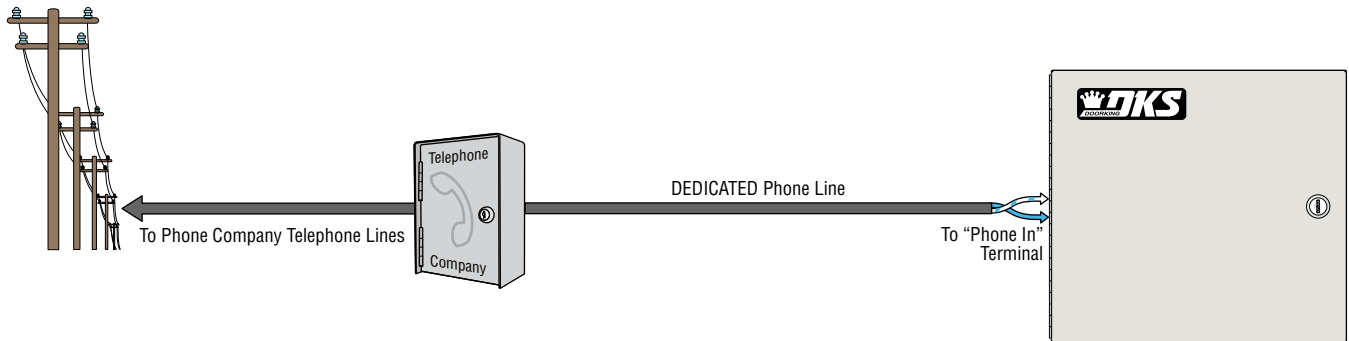

1.10 UL 294 Compliant Tamper Switch

The tamper switch needs to be connected to a security device or existing security system to comply with the UL 294 standard. Connect the 2 white wires of the **Normally Closed** gravity activated dry contact tamper switch to whatever security setup you desire. The gravity switch gets **activated** when the faceplate is **opened**. Repair and maintenance technicians may need to notify the proper authorities **BEFORE** opening the entry system faceplate, depending on how your security of this system has been setup.

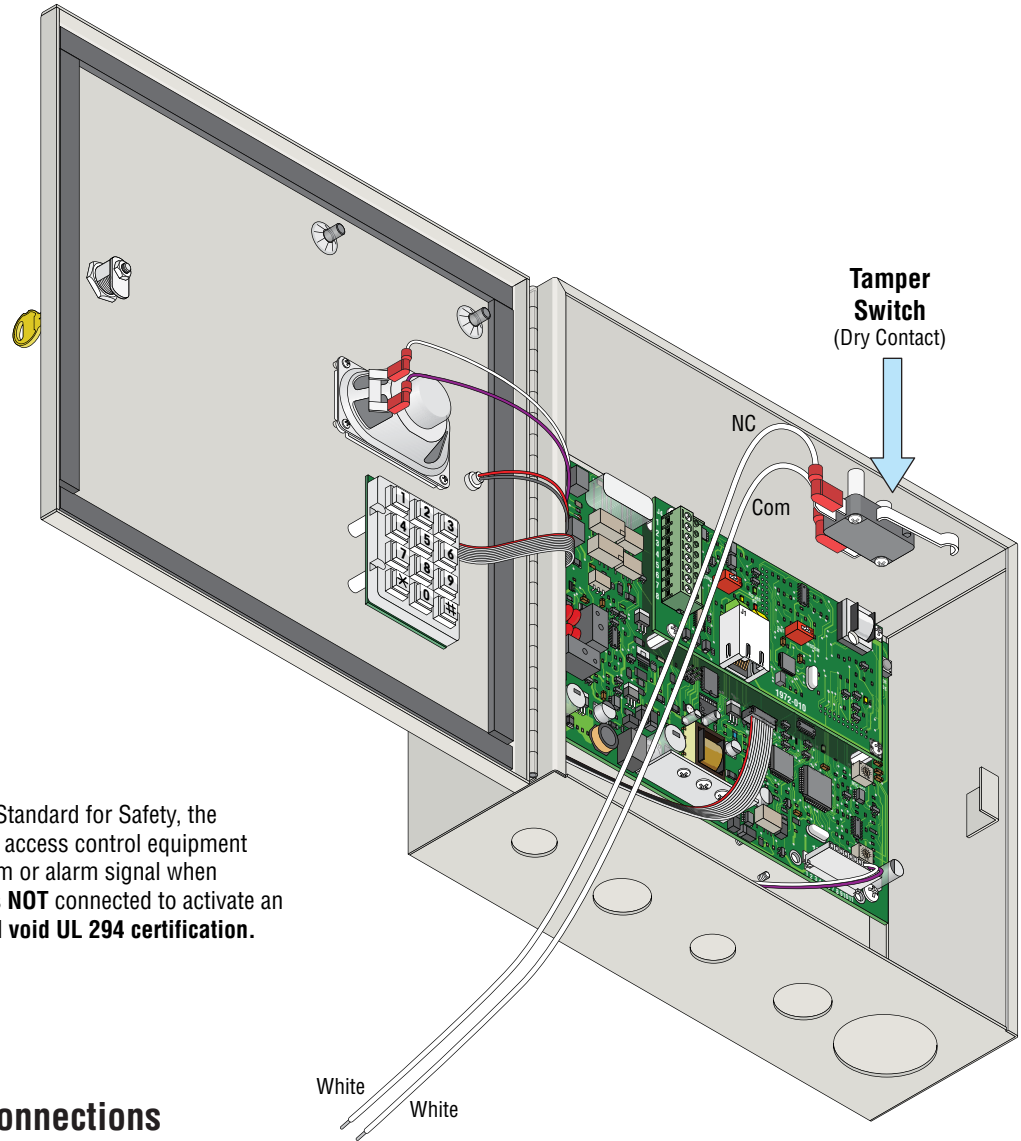

Note: To comply with UL 294 Standard for Safety, the tamper switch provided in this access control equipment must be set to activate an alarm or alarm signal when tripped. If the tamper switch is **NOT** connected to activate an alarm or alarm signal, **this will void UL 294 certification.**

Possible Security Connections

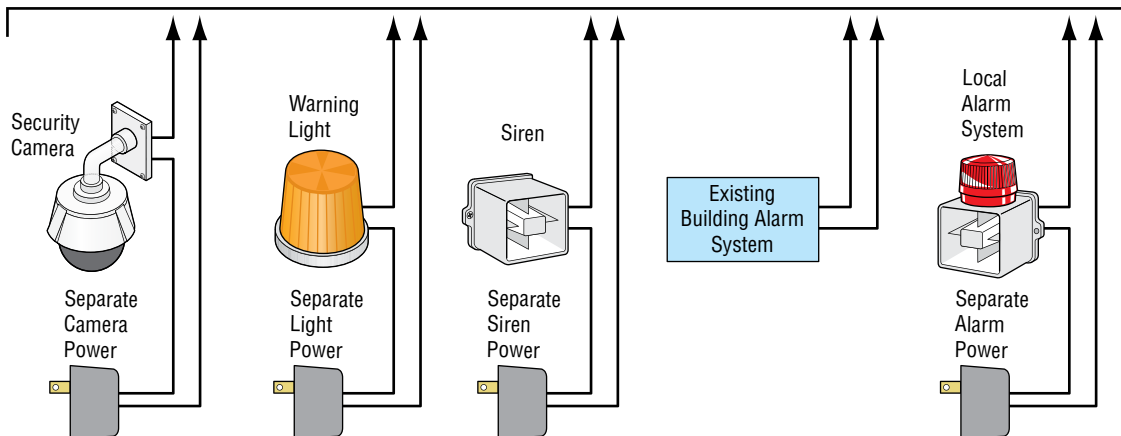

SECTION 2 - PROGRAMMING

Before You Start Programming: IMPORTANT! Make sure the 1838 has power and we strongly suggest that you become familiar with these programming instructions before beginning any programming of the 1838.

The unit has been programmed at the factory with many of the programming parameters already set (default setting) for a typical application. There is no need to reprogram these parameters unless you want to change them. For easy reference, refer to the chart on page 33 that list the various programming functions and their default settings.

2.1 Programming the Master Code

This programming step sets the system MASTER CODE. The master code is the four-digit number **required to gain access to the system memory**.

The unit comes from the factory **WITHOUT** a master code programmed into it. **You MUST program a MASTER CODE.**

The Master Code can **ONLY** be programmed from the system keypad.

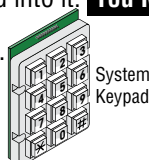

Step 1. Open the cabinet of the unit and press the master code button (See below). The **Blinking** LED right above the button will remain **ON**.

Note: After you press the master code push button, the blinking LED will stay **ON** indicating that you are in the master code programming sequence. If a master code is not entered within **10 seconds**, the master code program sequence will automatically end and the LED will return to a **blinking** state indicating that you have exited the master code programming sequence.

Step 2. Enter a four-digit master code then press * . any four numbers

Actual keystrokes used on system keypad: [?] [?] [?] [?] Then [*] “BEEP”

Same keystrokes as written in this manual: [_ _ _ _ * (beep)]

Step 3. The LED will revert to **Blinking**. Close the cabinet. **You should write down your master code, see note below.**

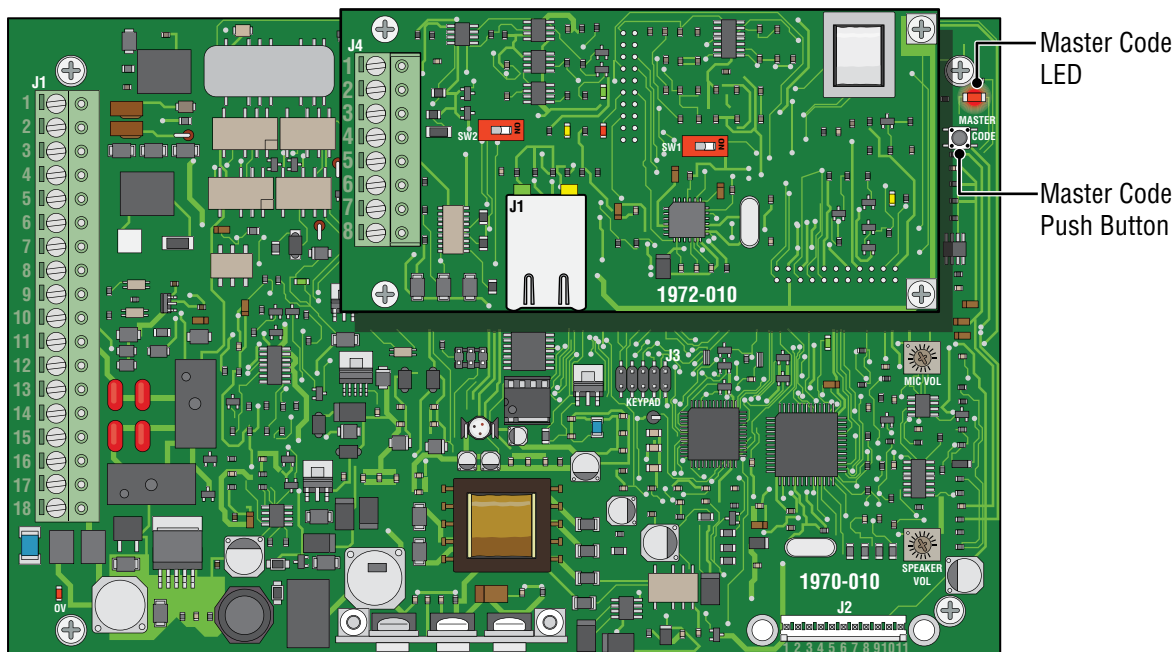

Programming Documentation Note: There are programming log sheets in the back of this manual to document your specific master code, and keep track of all other programming that is performed to this Access Plus system. Keep this with all other system documentation for future reference. **There is no way of retrieving the master code after it has been programmed in.** If you forget it, you will have to program in a new one but all other previously programmed information will remain intact.

2.2 Programming Methods

The 1838 can be programmed from a computer, the system keypad (Keypad in the unit) or from a touch-tone telephone (Telco phone line **MUST** be connected to 1838).

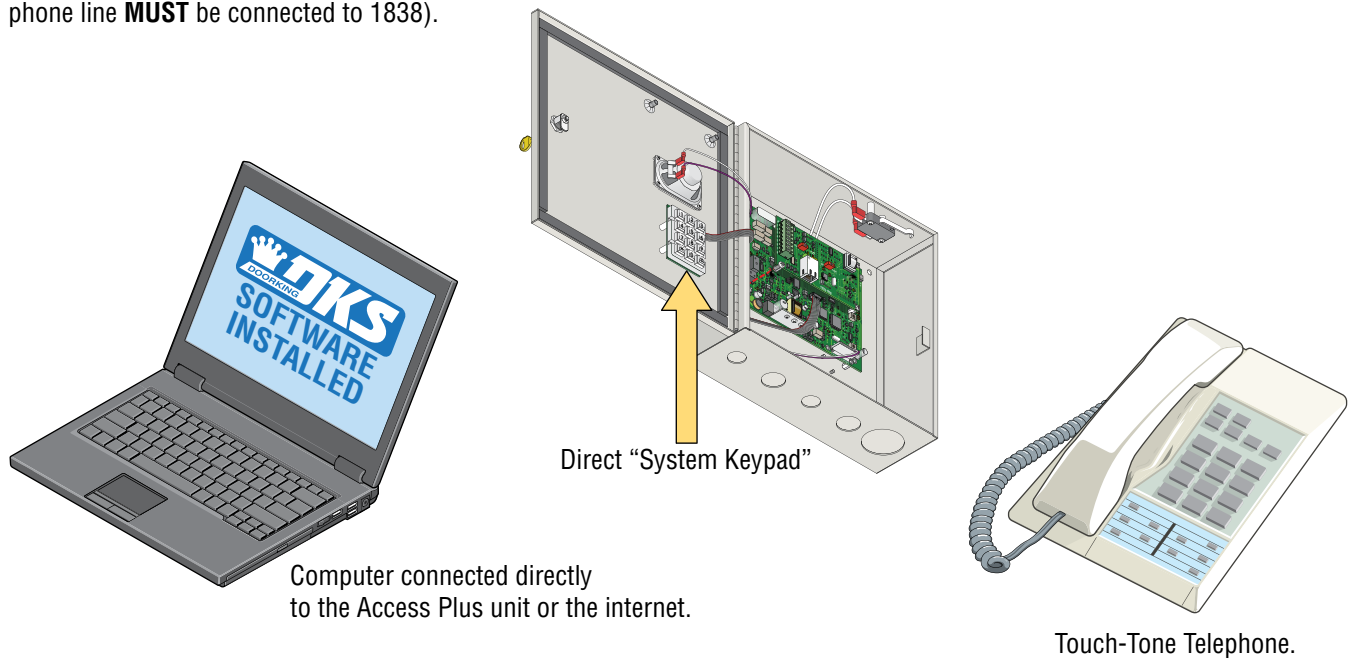

Computer connected directly to the Access Plus unit or the internet.

Touch-Tone Telephone.

We **highly recommend** programming the 1838 from a computer using the DoorKing Access Plus Management software as this greatly simplifies the programming task (See section 2.3 for more information). There are also several features in the 1838 that **MUST** be setup using a computer.

The following features and programming parameters can only be programmed from a computer:

Strike Out: This feature can be turned ON or OFF and will set the number of invalid access codes allowed before the system shuts down for a period of time. The default is OFF. This feature is only available with software version 1.05 or later.

Holiday Schedules: Program up to 31 different Holiday schedules. This feature can be turned ON or OFF. The default is OFF.

Email Notification: Set the 1838 to send emails to a specified email address on events of your choice. Requires an Internet connection. This feature can be turned ON or OFF. It comes from the factory with this feature turned OFF (factory setting OFF). Note: When the mail server uses SSL (Secure link), the unit cannot send e-mails.

Transaction Log: Download and view the system transaction log.

- **Computer - PC's only, NOT for use with MACs**

This is the **preferred method of programming the 1838 as it will simplify all of the programming steps** and allow you to enjoy all of the features and benefits available with this system. The Access Plus Management software must be installed on your computer and the unit must be connected to the computer via one of the methods shown in section 1.9.2 or 1.9.3. Refer to the Access Plus software help screens for more information.

- **System Keypad**

We strongly recommend that you become familiar with the entire programming sequence before attempting to program some of the more complex features of this system using the system keypad. **If you make a single error in the programming steps, you will have to re-do the sequence from step 1.**

- **Touch-Tone Telephone**

The programmable features that can be programmed using the system keypad can also be programmed using a touch-tone telephone connected to the 1838 through a Central Office phone line. This method of programming is useful for programming simple steps or for turning certain features ON or OFF, but is **not recommended for complex programming steps.**

2.3 Programming the Network Setup for a Computer

Before proceeding with any of the programming steps in this section, **install the Access Plus Management software on the computer (PC ONLY) that will be used** for this purpose. Be sure that the computer has a network card installed, or a modem installed in it (or connected to it) depending on which connection method will be used. Once the software is installed and the unit is connected, refer to the software programming steps and help screen instructions to proceed with the programming steps in this section. The system keypad may be used to program the computer's network setup in this section but can be a little tedious to use.

Be sure that SW1 is in the ON position (MODEM/TCP ENB) on the Access Plus Interface Board.

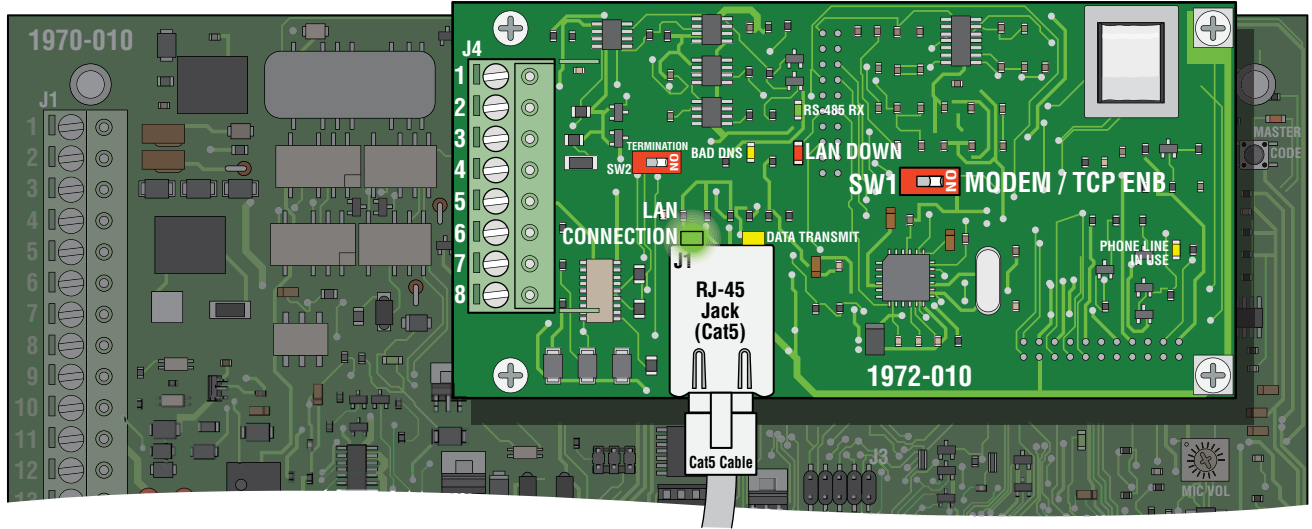

Reboot Note: If a programming step calls for a reboot, follow the programming steps in 2.3.5. If you are performing several programming steps that call for a reboot, complete **ALL** of those steps first, then perform the reboot sequence in 2.3.5.

Important Note: The unit will prompt you with short tones (**beep**) when each programming step has been correctly keyed in and with a long tone (**beeeeeep**) when all of the programming steps have been successfully completed in the sequence.

2.3.1 Set the 1838 IP Address *(reboot required)*

Factory setting is: 192.168.001.030

This must be set to the same address that was programmed in the software. A valid value for any of the three digit fields in this sequence is 000 to 255. (See section 1.9.2 for network configurations and addresses)

All 3 digits **MUST** be entered in each field between dots, for example: 192.168.1.30 must be entered as 192.168.001.030



1. Press * 5 1 and enter the MASTER CODE. [*** 5 1** ___ (beep)]
2. Enter the IP address. Use the * key to enter the "dot".
[___ * (beep) ___ * (beep) ___ * (beep) ___ * (beep)]
3. Press 0 # TOGETHER to end. [**0 #** (beeeeeep)]

2.3.2 Sub-Net Mask *(reboot required)*

Factory setting is: 255.255.255.000

All sub-net mask should be set to 255.255.255.000. This rarely needs to be changed, consult with your network expert first. Valid values for any of the three digit numbers is 000 to 255.



1. Press * 5 2 and enter the MASTER CODE. [*** 5 2** ___ (beep)]
2. Enter the sub-net mask number. Use the * key to enter the "dot".
[___ * (beep) ___ * (beep) ___ * (beep) ___ * (beep)]
3. Press 0 # TOGETHER to end. [**0 #** (beeeeeep)]

2.3.3 Set the Gateway (Router) IP Address *(reboot required)*

Factory setting is: 192.168.001.001

If the unit is connected directly to the computer with a crossover cable, then this address must be set to 000.000.000.000. If the unit is connected to the computer through a router, then set this value to the router's IP address. Valid value for any of the three digit numbers is 000 to 255. (See section 1.9.2 for network configurations and addresses)



1. Press * 5 3 and enter the MASTER CODE. [*** 5 3** _____ (beep)]
2. Enter the gateway (router) IP address. Use the * key to enter the "dot".
[_____ *****(beep) _____ *****(beep) _____ *****(beep) _____ *****(beep)]
3. Press 0 # TOGETHER to end. [**0 #** (beeeeeep)]

2.3.4 Set the Port Number *(reboot required)*

Factory setting is: 01030

This must be the same port number that was programmed in the software. Valid values are 01024 to 65535. All 5 digits must be entered in the field, for example: 1030 must be entered as 01030



1. Press * 5 6 and enter the MASTER CODE. [*** 5 6** _____ (beep)]
2. Enter the port number, then press *. [_____ ***** (beep)]
3. Press 0 # TOGETHER to end. [**0 #** (beeeeeep)]

2.3.5 Enable / Disable TCP / IP Support - System Reboot

Factory setting is: 0 (TCP / IP Disabled)

This programming sequence enables or disables the support for TCP / IP. It will also cause an automatic reboot of the unit two seconds after the programming sequence is completed. For this reason, perform this step after all other network setup programming sequences have been completed (sections 2.3.1 through 2.3.4) or whenever an individual network programming step is performed.



1. Press * 5 0 and enter the MASTER CODE. [*** 5 0** _____ (beep)]
2. Press 0 * to disable TCP / IP **OR** press 1 * to enable TCP / IP. [**_ *** (beep)]
3. **The system will reboot automatically.**

Once the unit is connected, the green LED on the RJ-45 jack on the interface board should light indicating that a good wire connection has been made (See illustration above). The LAN DOWN LED should go off after a few seconds if all previous programming steps have been completed and programmed successfully.

STOP! If you are **OR** are going to use a computer with the 1838, **NO other programming at the System Keypad is required.** All programming parameters beyond this point can be set in the Management software.

This software will show all the specific programming parameters that will exist in the memory of the 1838 after it has been programmed. It can be easily recalled for future modification or re-programming.

Download **Access Plus Account Manager** software at: <http://www.doorking.com/accessories/access-plus-software>

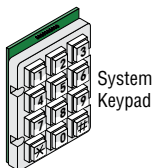

The system keypad **DOES NOT** have the capability to show any of the programming that will exist in the memory of the unit after being programmed. The only way to keep track of the specific parameters that have been programmed into the unit for future reference when **NOT** using the management software, is to physically write down all the information in a log (In back of manual).

2.4 System Parameters Programming

IMPORTANT! We strongly suggest that you read these programming instructions in their entirety before beginning any manual programming of the 1838.

The programming table on the next page provides a quick reference to:

Programming from the System Keypad

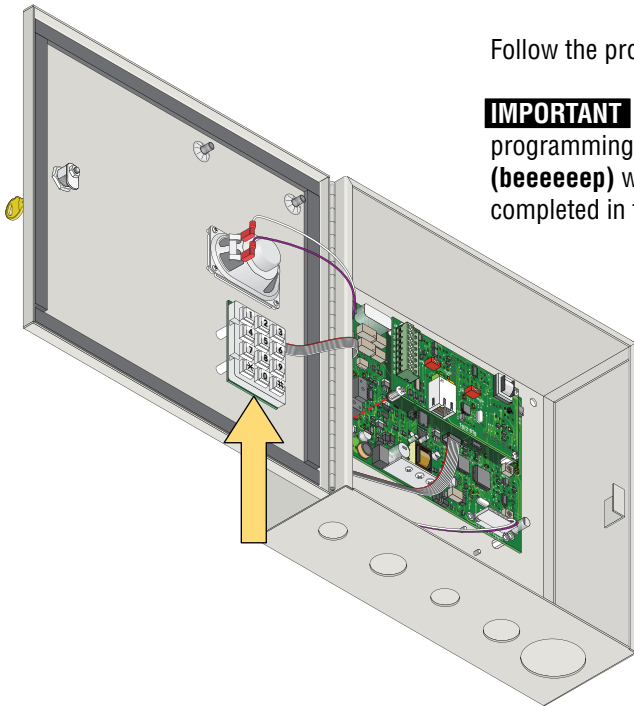

Follow the programming instructions as described in each section of this manual.

IMPORTANT The system will prompt you with short tones (**beep**) when programming steps have been correctly keyed in and with a long tone (**beeeeeep**) when all of the programming steps have been successfully completed in the sequence.

If you make a mistake while programming steps, press "0 #" together and start at step 1 again.

Programming from a Touch-Tone Telephone



Follow these steps when programming the 1838 from a **Touch-Tone Telephone**.

IMPORTANT The unit must have a phone line wired to it (section 1.7) and be programmed to answer incoming calls (section 2.4.9).

1. Call the resident telephone number. The unit will answer with a short beep after the programmed number of rings.
2. Follow the programming instructions as described in each section of this manual. The system will prompt you with short (beep) tones when programming steps have been followed correctly.
3. When complete, hang up. You cannot use 0# pressed together to end programming steps from a touch-tone telephone. Wait 30 seconds before calling back to program another feature.

Quick Reference Table

		Page #	Section	Command	Factory Settings
NOT Programmable from Software. Program from System Keypad ONLY.	Section 2.1 Programming Master Code				
	Program a Master Code	18	2.1	Press Master Code Button	NO Master Code Programmed
	Section 2.3 Programming Network Setup for a Computer				
	Set the Unit's IP Address (reboot required)	20	2.3.1	* 5 1	192.168.001.030
	Sub-Net Mask (reboot required)	20	2.3.2	* 5 2	255.255.255.000
	Set the Gateway (Router) IP Address (reboot required)	21	2.3.3	* 5 3	192.168.001.001
Set the Port Number (reboot required)	21	2.3.4	* 5 6	01030	
Enable / Disable TCP / IP Support - System Reboot	21	2.3.5	* 5 0	0	
Section 2.4 System Parameters Programming					
Relay Strike Time	24	2.4.7	* 0 3	1 Sec	
Tone Open Numbers	24	2.4.8	* 0 5	Relay 1: 9 8 7 6 Relay 2: 5 4 3 2 Relays 3-8 Not Set	
Answer Incoming Call on X Rings (Phone Line Required)	24	2.4.9	* 1 8	06 (6 Rings)	
Section 2.6 Access Codes for Access Control Devices					
Device Access Code Programming "Time Zone Restricted"	25	2.6.4	* 7 0	Empty	
Delete a Device Access Code	25	2.6.5	* 7 1	N / A	
Delete All Device Access Codes for Same Type of Device	25	2.6.6	* 7 2	N / A	
Section 2.7 Time Functions					
Time and Date Calendar Chip Programming	26	2.7.1	* 3 3	Empty	
Automatic Relay Activation Time Zone Programming (Up to 4 zones)	26	2.7.5	* 3 5	Empty	
Access Code Time Zone Programming (Up to 4 zones)	27	2.7.6	* 3 6	Empty	
Section 2.8 Miscellaneous					
Restore Factory Settings	27	2.8.1	* 9 0	N / A	
Erase Transaction Log	27	2.8.2	* 9 1	N / A	

Note: Program section numbers have been intentionally skipped that **DO NOT** apply to the 1838 Access Plus system in this manual. This allows **ALL** of the Access Plus manuals to remain in sync with each other when referencing programming numbers.

2.4.7 Relay Strike Time

Factory setting for Relays 1 and 2 is 01 (1 Second). Relays 3 through 8 are not set.

These steps will program the system relay strike times.

Strike times can be programmed from 1/4 second - enter 0 0 * in step 3, up to 99 seconds - enter 9 9 * in step 3. System relays 1 and 2 are the two relays on the 1838's main circuit board. System relays 3 through 8 are the relays associated with additional RS-485 devices (card readers, keypads, RF receivers, etc.) connected to the system.

1. Press * 0 3 and enter the MASTER CODE. [*** 0 3 _ _ _ _ (beep)**]
2. Enter a relay number (1 – 8), then press *. [**_ *(beep)**]
3. Enter the two-digit strike time (00-99), then press *. [**_ _ *(beep)**]
4. Repeat steps 2 and 3 to set other relay strike times if necessary.
5. Press 0 # TOGETHER to end. [**0 # (beeeeeep)**]

2.4.8 Tone Open Numbers

Factory setting is 9876 for Relay 1; 5432 for Relay 2. Relays 3 – 8 are not set.

These steps will program the tone open number(s) for each relay in the system (each relay is programmed independently). You will need to enter a four-digit number (see chart below) to set each relay in step 3. If a function is not desired, enter # in place of a number. Use a different number for each of the four-digits in step 3 when multiple functions are desired.

Example 1: If you want the relay to have a momentary activation function only, and you want the relay to activate when the number 9 is pressed, enter 9 # # # * in step 3.

Example 2: If you only want the relay to hold open when the number 8 is pressed and the relay deactivated when the number 7 is pressed, enter # 8 7 # * in step 3.

1. Press * 0 5 and enter the MASTER CODE. [*** 0 5 _ _ _ _ (beep)**]
2. Enter a relay number (1 – 8), then press *. [**_ *(beep)**]
3. Choose and enter a four-digit tone open number code (see chart below), then press *. [**_ _ _ _ *(beep)**]
If a tone open function is not desired, enter # in place of a number.
4. Repeat steps 2 and 3 to set other relay tone open number(s) if desired.
5. Press 0 # TOGETHER to end. [**0 # (beeeeeep)**]

4 Digit Tone Open Number Code	Function
1st Digit (Step 3)	Momentary activation. The relay will activate for its programmed relay strike time.
2nd Digit (Step 3)	Hold open. The relay will activate and remain activated until commanded to deactivate.
3rd Digit (Step 3)	Deactivate relay.
4th Digit (Step 3)	Hold open 1 hour. The relay will activate for 1 hour and then deactivate itself.

2.4.9 Answer Incoming Call on X Rings (Phone Line Required)

Factory setting is 06 (6 Rings).

This programming section sets the number of rings that the 1838 will allow to pass through it before it picks up the call. The number of rings to answer can be set from 1 to 12 rings and must be entered as a two-digit number.

For example, if you want the unit to answer the call after the sixth ring, enter 0 6 * in step 2. If you program 0 0 * in step 2, this will prevent (disable) the 1838 from answering incoming calls to it.

1. Press * 1 8 and enter the MASTER CODE. [*** 1 8 _ _ _ _ (beep)**]
2. Enter the number of rings (01-12), then press *. [**_ _ *(beep)**]
(enter 00 in this step to disable this feature)
3. Press 0 # TOGETHER to end. [**0 # (beeeeeep)**]

2.6 Access Codes to Operate Access Control Devices

Note: All access codes are five (5) digits in length.

2.6.4 Device Access Code Programming “Time Zone Restricted”

This programming sequence programs access codes into the system memory **with time zone restrictions**. It also allows programming of the **access codes to momentarily activate a relay or to hold open (latch) a relay**.

1. Press * 7 0 and enter the MASTER CODE. [*** 7 0** _ _ _ _ (beep)]
2. Enter the device type (0 = card, 1 = transmitter, 2 = keypad, 3 = other), then press *. [_ *****(beep)]
3. Choose and enter a five-digit access code, then press *. [_ _ _ _ _ *****(beep)]
4. Enter a minimum of 1, and a maximum of 4 time zones (valid time zones are 0 through 6) that you want to apply to this access code, then press *. [_ _ _ _ *****(beep)]
Time zone 0 - Always deny access.
Time zone 1 - Allows 24/7 access for relay 1 and any additional relays.
Time zone 2 - Allows 24/7 access for relay 2 and any additional relays.
Time zones 3, 4, 5 and 6 - Are time zones that have been programmed in 2.7.6.
5. Enter 0 * for momentary relay activation or enter 1 * to hold open (latch) the relay. [_ *****(beep)]
6. Repeat steps 2 through 5 to program additional access codes (Time zone restricted).
7. Press 0 # TOGETHER to end. [**0 #** (beeeeeep)]

If you make a mistake while programming steps, press “0 #” together and start at step 1 again.

2.6.5 Delete an Access Code

This programming sequence **deletes individual** access codes that have been programmed into the 1838.

1. Press * 7 1 and enter the MASTER CODE. [*** 7 1** _ _ _ _ (beep)]
2. Enter the device type (0 = card, 1 = transmitter, 2 = keypad, 3 = other), then press *. [_ *****(beep)]
3. Enter the five-digit device access code to be deleted, then press *. [_ _ _ _ _ *****(beep)]
See 2.6.1 and/or 2.6.4 for the five-digit access code.
4. Repeat steps 2 and 3 to delete additional existing “simple” and “time zone restricted” access codes.
5. Press 0 # TOGETHER to end. [**0 #** (beeeeeep)]

2.6.6 Delete All Access Codes for the Same Type of Device

This programming sequence deletes **ALL** existing “simple” and “time zone restricted (TZR)” access codes **for the same type of device**. To delete **ALL** existing “simple” and “time zone restricted” access codes, this programming sequence will need to be preformed for each type of device that is connected to the system.

WARNING: Once started, all “simple” and “time zone restricted” access codes for the same type of device will be erased.

1. Press * 7 2 and enter the MASTER CODE. [*** 7 2** _ _ _ _ (beep)]
2. Enter the device type (0 = card, 1 = transmitter, 2 = keypad, 3 = other), then press *. [_ *****(beep)]
3. Press 9 9 9 9, then press *. [**9 9 9 9** (beep)]
4. The programming sequence will end itself automatically. [beeeeeep]

2.7 Time Functions

2.7.1 Time and Date Calendar Chip Programming

This programming sequence programs the calendar chip in the 1838 for the current time and date. The calendar chip must be programmed if any of the time related features are going to be used.

Note: The clock / calendar chip in the 1838 will keep time for approximately 48 hours if power to the system is lost or removed. If power is off longer than this, the clock / calendar chip will have to be reprogrammed.

1. Press * 3 3 and enter the MASTER CODE. [*** 3 3 _ _ _ _ (beep)**]
2. Enter the current hour (01 to 12) and minutes (01 to 59), then press *. [**_ _ _ _ *(beep)**]
3. Press 0 * for AM **OR** press 1 * for PM. [**_ *(beep)**]
4. Enter the month (01 to 12), day of the month (01 to 31) and the year (00 to 99), then press *. [**_ _ _ _ _ *(beep)**]
5. Enter the day of the week (1-7), then press *. [**_ *(beep)**]
Sun = 1, Mon = 2, Tue = 3, Wed = 4, Thu = 5, Fri = 6, Sat = 7.
6. Press 0 # TOGETHER to end. [**0 # (beeeeeep)**]

Example: Saturday, February 14th, 2010, 11:30 AM. Your Master Code - **1. * 3 3 _ _ _ _ (beep)**

Time - **2. 1 1 3 0 *(beep)**

AM - **3. 0 *(beep)**

Date - **4. 0 2 1 4 1 0 *(beep)**

Day - **5. 7 *(beep)**

End Programming - **6. 0 # TOGETHER (beeeeeep)**

If you make a mistake while programming steps, press "0 #" together and start at step 1 again.

2.7.5 Automatic Relay Activation Time Zone Programming (Up to 4)

Factory setting in step 3 is 0 (Time zones are OFF).

This program sequence sets up time zones to automatically activate and deactivate relays 1 through 8. Up to **Four** time zones can be programmed, each of which can be assigned to the desired relay(s). These time zones can be independently turned ON or OFF after they have been programmed.

1. Press * 3 5 and enter the MASTER CODE. [*** 3 5 _ _ _ _ (beep)**]
2. Enter a time zone number (1, 2, 3 or 4), then press *. [**_ *(beep)**]
3. Press 0 * to turn the time zone OFF, **OR** press 1 * to turn the time zone ON. [**_ *(beep)**] You can terminate here (Go to step 11 to finish) if you have previously programmed the time zones and only ON / OFF is desired.
4. Enter the beginning hour (01 to 12) and minutes (01 to 59), then press *. [**_ _ _ _ *(beep)**]
5. Press 0 * for AM **OR** press 1 * for PM. [**_ *(beep)**]
6. Enter the ending hour (01 to 12) and minutes (01 to 59), then press *. [**_ _ _ _ *(beep)**]
7. Press 0 * for AM **OR** press 1 * for PM. [**_ *(beep)**]
8. Enter the days of the week that the auto relay time zone is to be active, then press *. [**_ _ _ _ _ *(beep)**]
Sun = 1, Mon = 2, Tue = 3, Wed = 4, Thu = 5, Fri = 6, Sat = 7.
You can enter up to 7 numbers here (1-7) but all 7 spaces do not have to be populated with numbers. For example, for the auto relay time zone to be active only on Saturdays and Sundays, enter 1 7 *. The order of the numbers is not important; 17 is the same as 71.
9. Enter the relay number(s) that the time zone will apply to, then press *. [**_ *(beep)**]
You can enter a single relay number; all relay numbers (up to 8), or any combination of relay numbers.
10. Repeat steps 2 through 9 to program the other auto relay time zones (up to 4) if desired.
11. Press 0 # TOGETHER to end. [**0 # (beeeeeep)**]

2.7.6 Access Code Time Zone Programming (Up to 4 zones)

Factory setting in step 3 is 0 (Time Zones are OFF).

This programming sequence sets up time zones (up to 4) that can be applied to the “Access Codes” programmed in section 2.6.4 into the 1838. These time zones can be turned ON or OFF once they have been programmed.

1. Press * 3 6 and enter the MASTER CODE. [*** 3 6** _ _ _ _ (beep)]
2. Enter a time zone number (3, 4, 5 or 6), then press *. [**_ ***(beep)]
Do not use 0, 1 or 2 for time zone numbers. These are already used; **0** = always deny, **1** = 24/7 access for Relay 1, and Relays 3-8; **2** = 24/7 access for Relay 2, and Relays 3-8.
3. Press 0 * to turn the time zone OFF, **OR** press 1 * to turn the time zone ON. [**_ ***(beep)]
You can terminate here (Go to step 11 to finish) if you have previously programmed the time zone and only ON / OFF is desired.
4. Enter the beginning hour (01 to 12) and minutes (01 to 59), then press *. [**_ _ _ _ ***(beep)]
5. Press 0 * for AM **OR** press 1 * for PM. [**_ ***(beep)]
6. Enter the ending hour (01 to 12) and minutes (01 to 59), then press *. [**_ _ _ _ ***(beep)]
7. Press 0 * for AM **OR** press 1 * for PM. [**_ ***(beep)]
8. Enter the days of the week that the time zone is to be active, then press *. [**_ _ _ _ _ _ ***(beep)]
Sun = 1, Mon = 2, Tue = 3, Wed = 4, Thu = 5, Fri = 6, Sat = 7.
You can enter up to 7 numbers here (1-7) but all 7 spaces do not have to be populated with numbers. For example, for the time zone to be active only on Saturdays and Sundays, enter 1 7 *. The order of the numbers is not important; 17 is the same as 71.
9. Enter the relay number(s) that the time zone will apply to, then press *. [**_ ***(beep)]
You can enter a single relay number; all relay numbers (up to 8), or any combination of relay numbers.
10. Repeat steps 2 through 9 to program the other time zones (up to 4) if desired.
11. Press 0 # TOGETHER to end. [**0 #** (beeeeeep)]

If you make a mistake while programming steps, press “0 #” together and start at step 1 again.

2.8 Miscellaneous

2.8.1 Restore Factory Settings

This step will restore the factory settings for each of the programming parameters. See the “Quick Reference Table” on page 23 for all of the factory settings. The master code (2.1) will remain intact after the factory settings have been restored.

WARNING: Once started, this sequence will program all values to factory settings.

1. Press * 9 0 and enter the MASTER CODE. [*** 9 0** _ _ _ _ (beep)]
2. Press 9 9 9 9, then press *. [**9 9 9 9** (beep)]
3. The programming sequence will end itself automatically. [beeeeeep]

2.8.2 Erase Transaction Log

This step will erase (empty) the transactions stored in the 1838 history buffer (the system stores up to 500 transactions).

WARNING: Transaction log cannot be recovered after this sequence is started.

1. Press * 9 1 and enter the MASTER CODE. [*** 9 1** _ _ _ _ (beep)]
2. Press 9 9 9 9, then press *. [**9 9 9 9** (beep)]
3. The programming sequence will end itself automatically. [beeeeeep]

SECTION 3 - USER INSTRUCTIONS

Interface Board LED Status

RS-485 RX - Green LED indicates that the system is on-line and scanning the RS-485 devices.

BAD DNS - Yellow LED indicates an email server problem, rejecting the mail server.

LAN DOWN - Red LED indicates a problem with the LAN. IP or Gateway (router) down or wrong gateway IP address.

PHONE LINE IN USE - Yellow LED indicates that the phone line is being used (dial-out, call forwarding, etc.).

LAN CONNECTION - Green LED indicates that the wire connection from the unit to the computer or router is good.

DATA TRANSMIT - Yellow LED indicates that the TCP / IP connection is transmitting data or sending an email.

SW1 - Modem/TCP Enable - Turning SW1 Off disables the modem and TCP / IP, but will speed up programming from the keypad.

SW2 - Termination Switch - Only used when RS-485 access control devices are being used (See section 1.9.1).

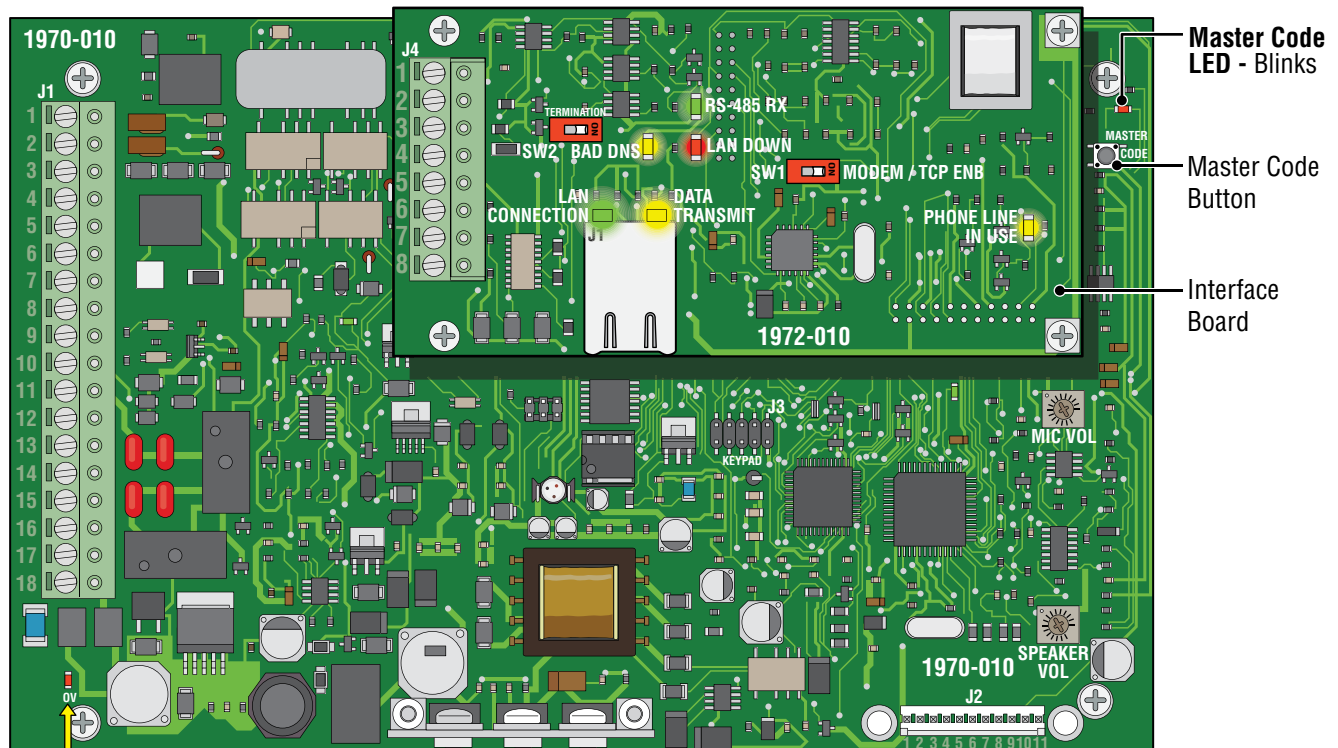

Over Voltage LED: OV LED will light up if too much power is applied to circuit board. Board automatically shuts down.

System Keypad

Used to program system features.

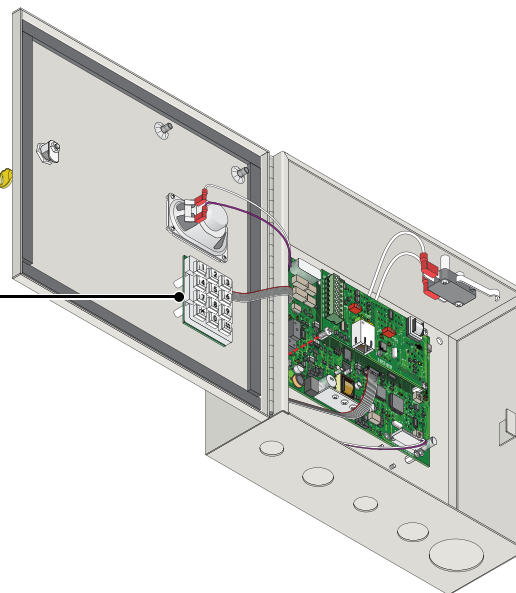

3.1 Remote Touch-Tone Phone Operation

3.1.1 Remote Programming

Applicable only if a telephone line is connected to the 1838. The 1838 can be programmed and operated from a touch-tone telephone. Be sure that the ability for the 1838 to answer an incoming call has not been disabled (section 2.4.9).

Note: The master code cannot be programmed remotely, it can only be programmed from the system keypad (section 2.1).

1. Call the 1838's phone number. After the programmed number of rings (2.4.9) the 1838 will answer with a tone.
2. Follow the desired programming steps in Section 2 of this manual.
3. When complete with the desired programming function, hang up. You cannot use 0# pressed together to end programming steps from a touch-tone telephone. Wait 30 seconds before calling back to program another feature.

3.1.2 Remote Relay Activation

Applicable only if a telephone line is connected to the 1838. The 1838 relays can be activated from a Touch-Tone phone. Be sure that the ability for the 1838 to answer an incoming call has not been disabled (section 2.4.9). Refer to the tone open numbers that were programmed in section 2.4.8 to determine each of the activation numbers.

- **Momentary Activation** (Relay activates for its programmed relay strike time, section 2.4.7).
- **Hold Open** (Relay will activate and remain activated).
- **Deactivate** (Relay will deactivate).
- **Hold 1 Hour** (Relay will activate for 1 hour and then automatically deactivate).

To activate the relay(s) from a touch-tone phone, perform the following steps:

1. Call the 1838's phone number. After the programmed number of rings (2.4.9) the 1838 will answer with a tone.
2. Press * 1 6 and enter the MASTER CODE. [* 1 6 _ _ _ _ (beep)]
(Two-way voice communication is also enabled at this point)
3. Enter the desired tone open number (2.4.8). [_ (beep)]
4. Press "0" to Hang up.

SECTION 4 - MAINTENANCE

The DoorKing 1838 access controller is essentially a maintenance free device. When the unit is properly installed, it should provide years of trouble free service. Maintenance is limited to updating the access codes on an as needed basis.

4.1 Troubleshooting

If problems should develop with your 1838, refer to section 4.2 troubleshooting table to try and correct any problems. Our experience has shown that a majority of reported problems are actually programming related and can be corrected on site. If problems persist and they cannot be corrected, contact your authorized DoorKing dealer for assistance. Before performing any troubleshooting, check the following:

1. Have a good VOM meter handy to check voltages and continuity.
2. Have a telephone test set (DoorKing P/N 1800-050 or equivalent) to check the telephone line if using phone line. Noise on the phone line will cause problems with the 1838.
3. Check the polarity of the phone lines (if using the phone modem for programming).
4. Be sure that the 1838 case is properly grounded.
5. Be sure that the telephone wires are twisted.
6. A hum on the system (if using the modem for programming) indicates that the phone line or 16 VAC power lines may be grounded. Check to be sure that the phone lines or power lines are not shorted to ground. Be sure that the cable used for communication is a twisted pair, good quality phone cable insulated for direct underground burial. **Using phone wire that is designed for indoor use only can absorb moisture and cause a hum on your phone line.**
7. Check the 16.5 VAC system power. Be sure that the transformer is properly rated (20 VA). **DO NOT USE 24 VAC POWER.** Keep the wire run from the transformer to the entry system as short as possible. Use 16 or 18 AWG, 600 volt insulated wire only. **The importance of proper power wiring cannot be over stressed!**

4.2 Troubleshooting Table

Symptom	Possible Solution(s)
Board does not power up.	<ul style="list-style-type: none"> • No power. Check for 16 VAC input power. • If OV LED is ON, input voltage is too high. Insure that the transformer connected to the input terminals is 16 VAC.
Cannot get into programming mode.	<ul style="list-style-type: none"> • Wrong master code entered. Start over. • Waiting too long between pushing buttons. Enter information quicker. • Keypad is not plugged into board correctly. Cable points down.
System emits a long tone and cancels programming.	<ul style="list-style-type: none"> • Waiting too long between pushing buttons. • Forgetting to press “*” first when programming.
Keypad is dead.	<ul style="list-style-type: none"> • No power. Check for 16 VAC input power. • Check that the keypad is properly connected to the circuit board. The cable on the plug points down when connected to the circuit board.
Buzz or noise on the line.	<ul style="list-style-type: none"> • Check for a short to ground behind the circuit board. • Check for pinched wires near the door hinge. • Check for 16-volt power shorted to a conduit. • Check for a phone line shorted to ground. • Check that the phone wires are twisted. • Check that all wires, speaker, keypad, etc., are isolated from ground. • Check that the cabinet is properly grounded. Be sure case ground (terminal 3) is not used as a low voltage common. • Check for excessive voltage drop on 16 VAC power. • Check phone line with telephone test set.
System will not answer when called from a remote location.	<ul style="list-style-type: none"> • Answer incoming call feature is turned off. Turn answer incoming call feature on. • Number of rings to answer may be programmed too high. Reprogram number of rings to answer.
Electric strike locks on or gate operator holds open.	<ul style="list-style-type: none"> • Excessive voltage drop on 16 VAC line. • Hold open schedule is enabled. Turn off hold open schedule or reprogram time zone. • Access code used was programmed under a hold location code. Reprogram access code into a momentary activation location code. • A hold command was sent to the relay from the resident's phone. Deactivate the relay using the resident's phone.
Access code will not work.	<ul style="list-style-type: none"> • Forgetting to press # first. • Access code is time zone restricted and the access code time zone is enabled. Turn access code time zone off, reprogram time zone boundaries or reprogram access code without a time zone.

4.3 1838 Access Plus Wiring Schematic

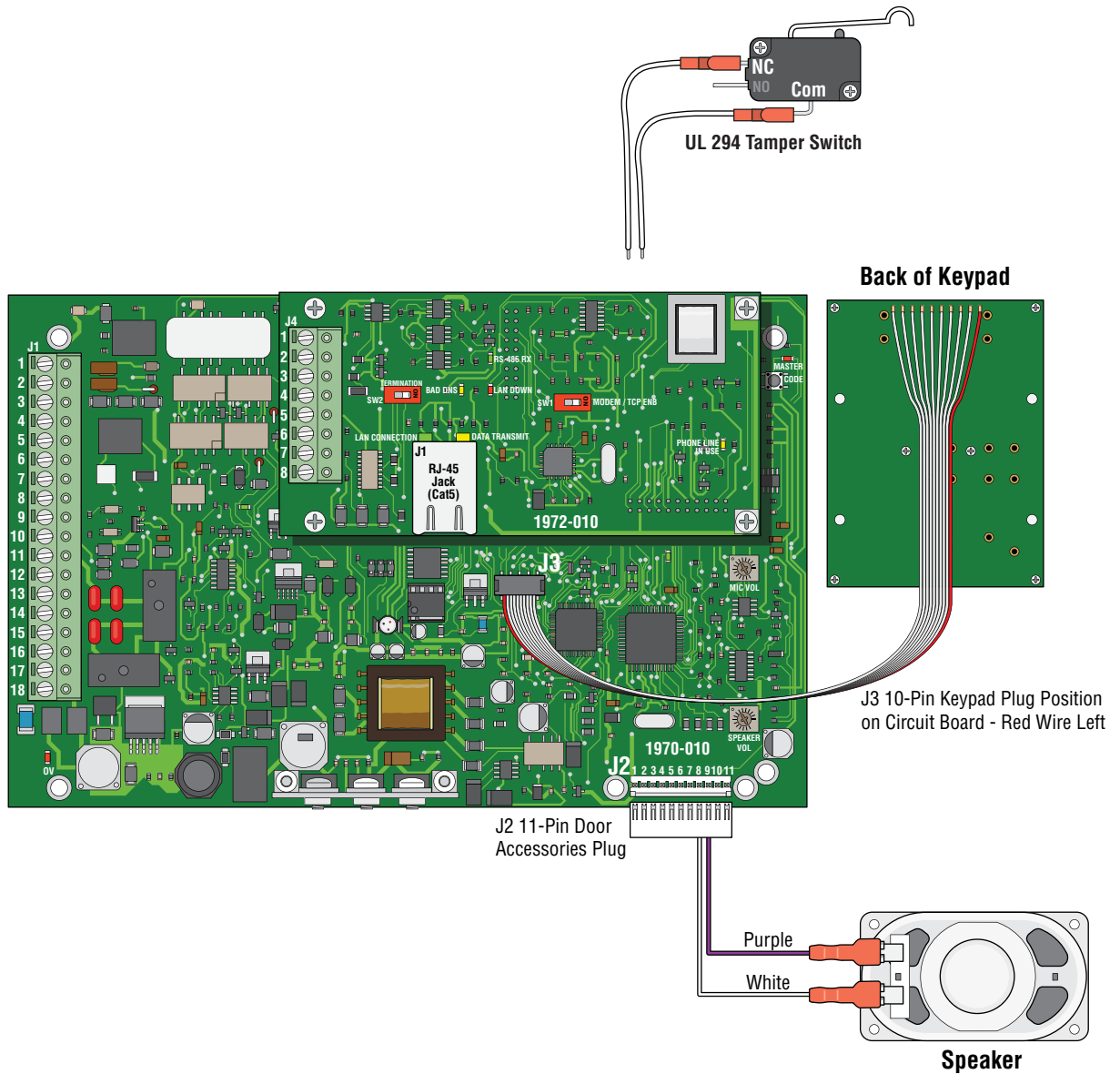

4.4 Accessories

RS-485 Card Readers

P/N 1815-232 (uses DKS reader)

P/N 1815-233 (uses AWID reader)

P/N 1815-234 (uses HID reader)

RS-485 Keypads

P/N 1513-080 (surface mount, non-lighted)

P/N 1513-081 (surface mount, lighted)

P/N 1513-082, (flush mount, lighted)

RS-485 RF Receiver

P/N 8053-080 (MicroPlus receiver)

Secondary Keypads: Allows remote activation of the system relays by use of the access codes. Does not provide any voice communication to the main unit or to the resident telephone.

P/N 1812-082 (surface mount)

P/N 1812-197 (flush mount)

Surge Suppressors:

High voltage (115 V) suppressor. P/N 1879-010.

Phone line suppressor. P/N 1877-010.

Low voltage (28 V) suppressor. P/N 1878-010.

Mounting Posts:

P/N 1200-045 Standard Gooseneck Pad Mount

P/N 1200-046 Standard Gooseneck In-ground Mount

Telephone Test Set: Includes clips, cord and carrying case. P/N 1800-050.

Standby Battery: 12 volt .8 amp hour gel cell provides stand by power during power interruptions. P/N 1801-008.

Postal Lock Box: Provides a means for the mail carrier to enter the premise to deliver mail. P/N 1402-080.

Magnetic Locks: A variety of magnetic locks are available to meet individual application requirements.

Contact your DoorKing dealer.

Electric Strikes: A variety of electric strikes are available to meet individual application requirements.

Contact your DoorKing dealer.

4.5 Programmed Information Log Sheets

Complete the information in the tables on the following pages to maintain a record of the information that has been programmed into the 1838. 1838 Access Plus manual is available on-line at: www.doorking.com if extra log sheets are required.

Master Code (section 2.1)			
1st Digit	2nd Digit	3rd Digit	4th Digit

Relays (section 2.4.7)								
Tone Number Function	1 Internal	2 Internal	3 External	4 External	5 External	6 External	7 External	8 External
Momentary Activation								
Hold Open								
Deactivate Relay								
Hold Open 1 Hr.								

Access Code Time Zone Schedule (section 2.7.6)				
	Time Zone 1	Time Zone 2	Time Zone 3	Time Zone 4
Beginning Time				
Ending Time				
Days of the Week				
Relays				

Automatic Relay Activation Time Zones (Hold Open Schedules) (section 2.7.5)				
	Time Zone 1	Time Zone 2	Time Zone 3	Time Zone 4
Beginning Time				
Ending Time				
Days of the Week				
Relays				



Download **ACCESS PLUS ACCOUNT MANAGER** Software **FREE** at:
<http://www.doorking.com/accessories/access-plus-software>

www.doorking.com

DoorKing, Inc.
120 S. Glasgow Avenue
Inglewood, California 90301
U.S.A.

Phone: 310-645-0023
Fax: 310-641-1586