

# DKS SMART GATE CONTROLLER

DoorKing Part Number  
**1800-500**

Monitor and control your gate from anywhere. With the combined power of the DKS Smart Gate Controller, Smart Connect App, and your existing WiFi connection, you can open and close your gate from anywhere — right on your smartphone. Simply wire the Smart Gate Controller to any gate operator that has a built-in reply switch (or USER SUPPLIED gate position switch) and your existing WiFi.

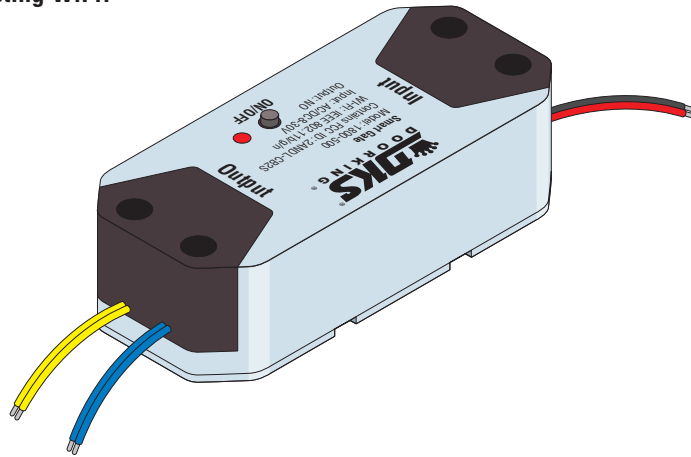

## Can be linked to personal networks for voice activation:



Google HOME

Hey Google, open the DoorKing Smart Gate.  
Hey Google, close the DoorKing Smart Gate.



Alexa, open the DoorKing Smart Gate.  
Alexa, close the DoorKing Smart Gate.



Hey Siri, open the DoorKing Smart Gate.  
Hey Siri, close the DoorKing Smart Gate.

## WARNING!

- **DO NOT** let children use or play with the Smart Gate device or App.
- **ONLY** operate your Smart Gate device when you are in **clear view of your gate**, and you have **verified** that there are no objects obstructing the operation of the gate.
- **ALWAYS** wait for the gate to **complete its cycle before leaving the area**.
- This device complies with Part 15 of the FCC Rules. Operation is subject to the following two conditions:
  - (1) this device may not cause harmful interference, and
  - (2) this device must accept any interference received, including interference that may cause undesired operation.

## Table of Contents

Set up your DKS Smart Connect account	2
Preparation Before Final Installation	2
Add Smart Connect Device to DKS Smart Connect app	2
Install your DKS Smart Gate Controller	3-5
DKS Smart Connect App	6
Link DKS Smart Connect account to Alexa	7
Link DKS Smart Connect account to Google Home	8
Set Up Siri to Control the DoorKing Smart Gate	9

## Set up your DKS Smart Connect account

First, download DKS Smart Connect app for your iOS or Android device. Make sure you have the latest version of DKS Smart Connect from the app store.



Next, create your account.

If you're new to DKS Smart Connect, tap **Sign UP** to create an account. Enter your e-mail address, then tap **Get Verification Code**, enter the code you receive in your e-mail to set up the **Password**.

If you already have an DKS Smart Connect account used for other devices, tap **Log in with Existing Account**.

## Preparation Before Final Installation

First, Check your Wi-Fi signal strength at gate operator (2.4 Ghz ONLY) Check the Wi-Fi signal where the Smart Gate Controller will be installed using your smart phone.

**IMPORTANT**

Next, Power up your Smart Gate Controller.

At the installation location, power up the Smart Gate Controller by connecting it to an 8-30V power source (AC/DC) (see pages 4-5). The device's LED will blink.



Make sure gate operator's power has been turned OFF BEFORE wiring to it.

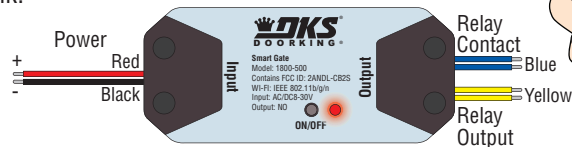

**DO NOT** install the DKS Smart Gate Controller if the Wi-Fi signal is unacceptable.

## Add Smart Connect Device to DKS Smart Connect app

Turn on smart phones **bluetooth** and Connect smartphone to your home Wi-Fi network **BEFORE** the following steps. Have your SSID WiFi name ready, with WiFi password if asked.

**Make sure DKS Smart Connect has access to nearby devices from your cell phone.**

**Android:** Settings – Apps – Select DKS Smart – Permissions: Make sure “nearby devices”, is listed under Allowed.

**I-Phone:** Settings-Privacy & Settings – Bluetooth – DKS Smart needs to show enabled.

- 1 Launch the app and tap the Plus (+) in the top right corner to add a device.
- 2 Press ON/OFF Button until LED flashes. Tap (Add) on your phone.
- 3 Enter your Wi-Fi name and password, then tap Confirm.
- 4 Now your DoorKing Smart Gate has been successfully added to DKS Smart Connect app. Tap Done.

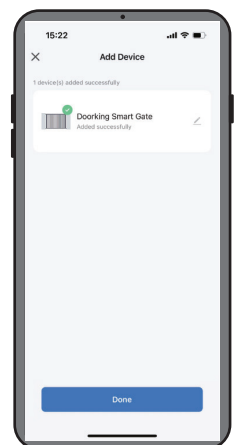
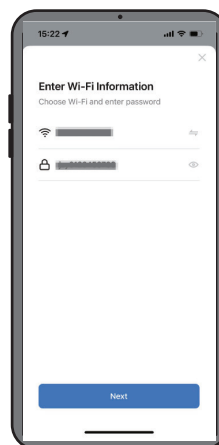
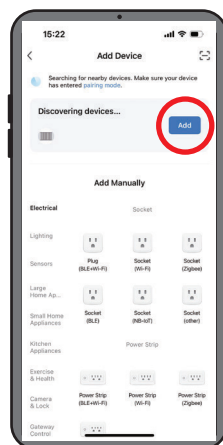
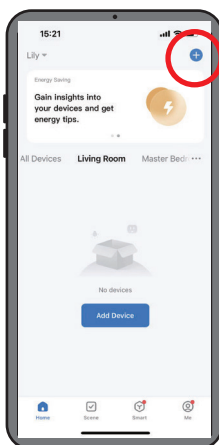

**NOTE:** if LED is **NOT** flashing, press and hold the ON/OFF button for 8 seconds (Until it flashes)

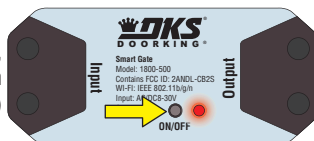

**NOTE:** If device does not show under discovered devices, press and hold the button on the device for about 8 seconds (Until LED flashes red). Make sure DKS Smart app has access for nearby devices.

# Install your DKS Smart Gate Controller

The DKS Smart Gate Controller's signal is impeded by **metal**. Make sure that the place where you are installing it has a strong Wi-Fi signal (see previous page "**Preparation Before Installation**").

The operator cover can also diminish the signal. If the controller is being installed **INSIDE** the operator, test it with the operator cover on and see if signal strength is acceptable.

**NOTE:** In the app, you can check wireless signal strength, "**Check Device Network**"

DoorKing's recommendation is 67dbm or below. The cell phone must be connected to same Wi-Fi as the DKS Smart Gate Controller.

If the controller is installed **OUTSIDE** the operator, make sure to use a waterproof plastic box (not provided) to protect the controller.

After you are satisfied with the Wi-Fi signal strength in the location where you are installing your DKS Smart Gate Controller, find your **specific** DoorKing operator on the next 2 pages to show how to wire the controller to it.

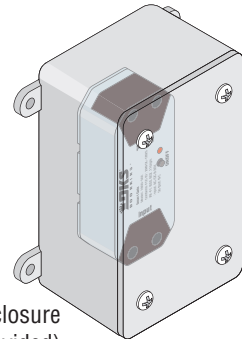

Waterproof Enclosure  
(not provided)

## POWER OFF your existing gate operator BEFORE installation

### Kit Includes:

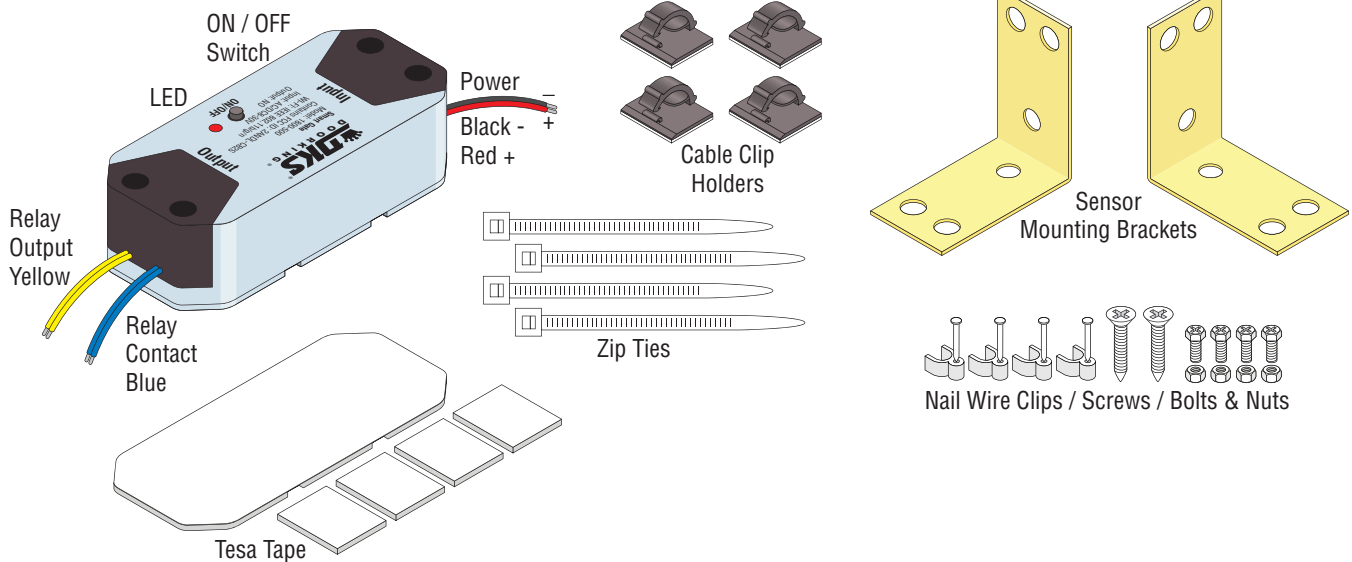

### Gate Position Switch (User Supplied)

Without a gate open position switch connected to the blue wires, the Smart Gate Switch **WILL NOT** be able to provide information as to whether the gate is open or closed. Use the built-in relay that is available on every DKS gate operator circuit board to provide the gate open indication to the Smart Gate Switch (see pages 4-5).

**Note:** The relay jumper on the DKS gate operator circuit board is set to **NC (Normally Closed)**, and the relay is set to activate when the **gate reaches the full open position**.

Other brand gate operators may have the same type of relay connection available. Check the manufacturer's installation manual for information.

If a gate open relay is **NOT** available, a separate switch (user supplied) will need to be wired to the Smart Gate Switch, otherwise the position of the gate **WILL NOT** be available on the app.

**IMPORTANT:** The gate open switch **MUST** be wired **Normally Closed**. When the gate reaches the **full open position**, the switch **opens**.

## 9100, 9150 Slide Gate Operators

## 6050, 6100, 6300 Swing Gate Operators

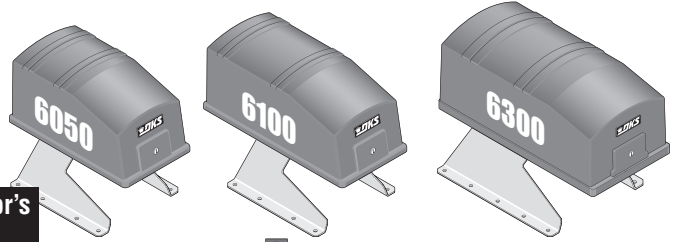
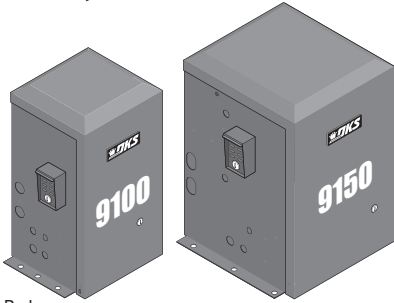

**Make sure gate operator's power has been turned OFF BEFORE wiring to it.**

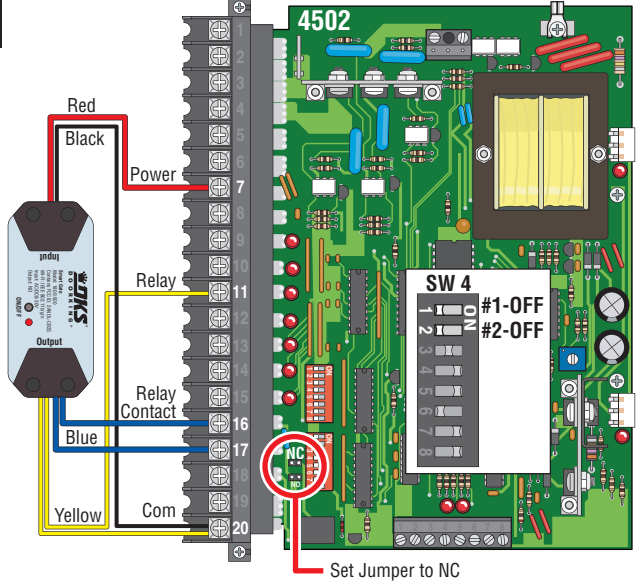
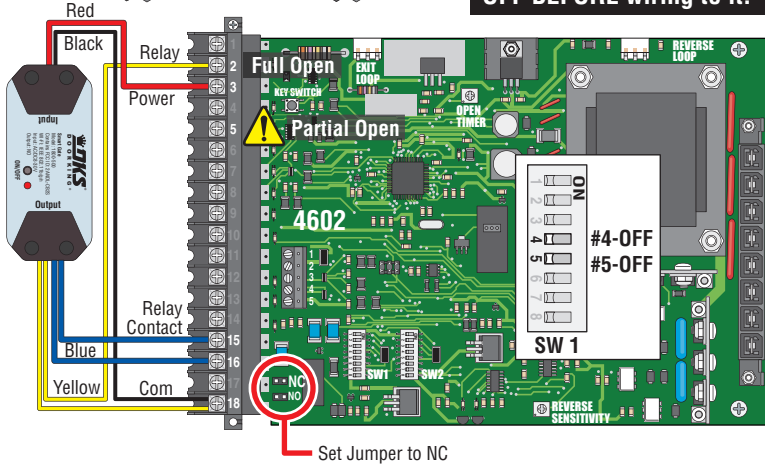

## AC Powered 6524 Swing Gate Operators, AC Powered 9024 Slide Gate Operators

AC Powered ONLY

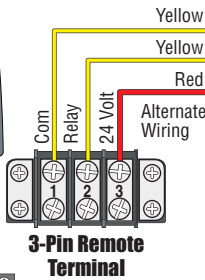
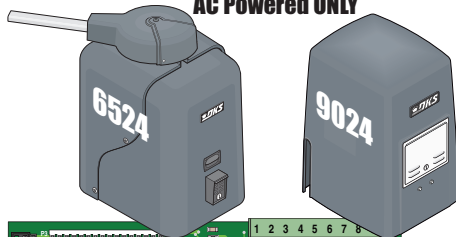

## 6500 Series Swing Gate Operators, 9000 Slide Gate Operators

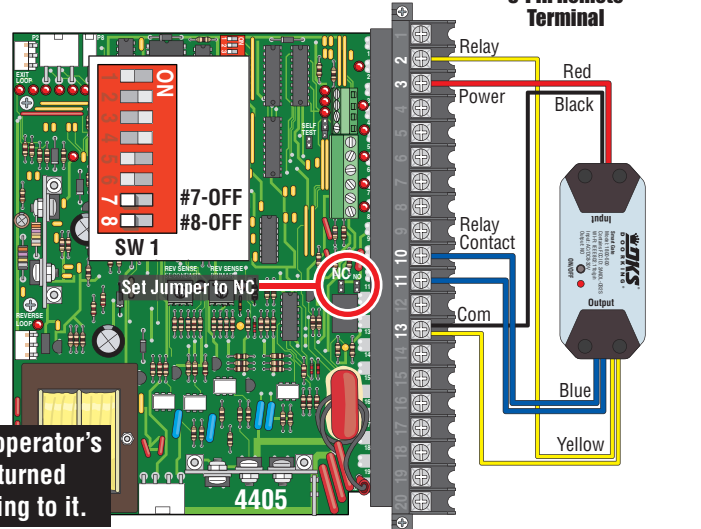
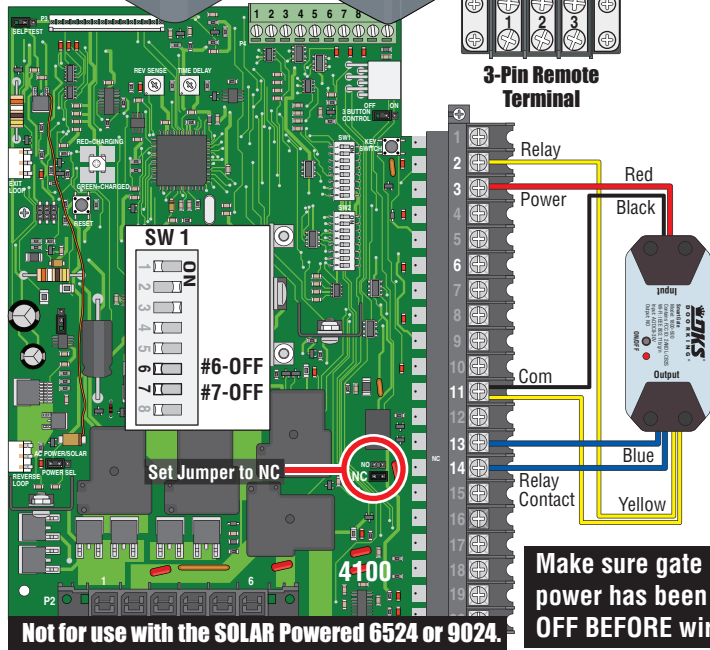
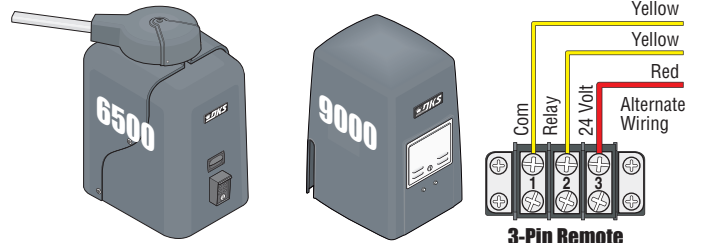

**Make sure gate operator's power has been turned OFF BEFORE wiring to it.**

Not for use with the SOLAR Powered 6524 or 9024.

## 6004, 6006, 6400 Swing Gate Operators

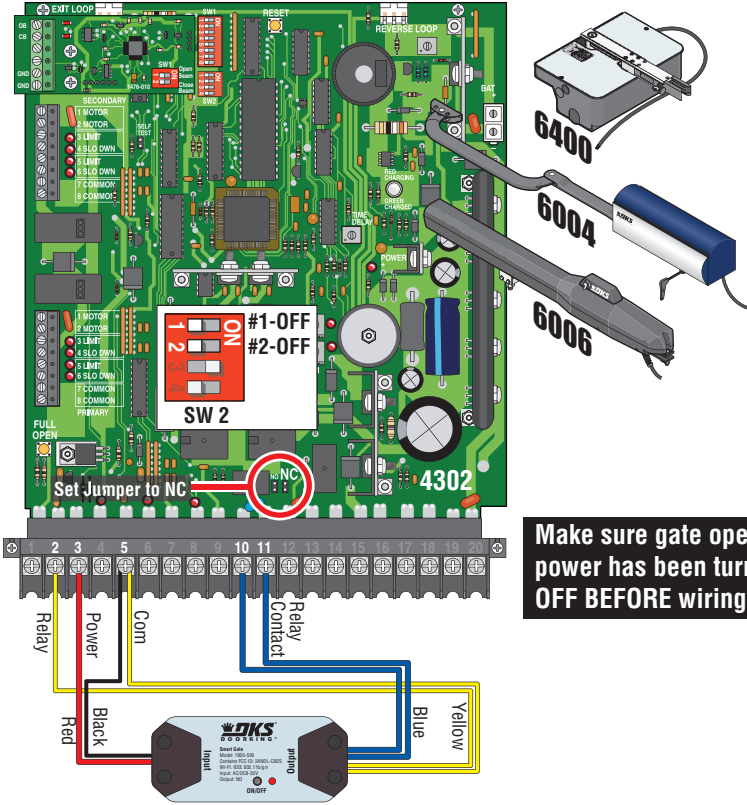

Make sure gate operator's power has been turned OFF BEFORE wiring to it.

## 9200 Series, 9500 Slide Gate Operators

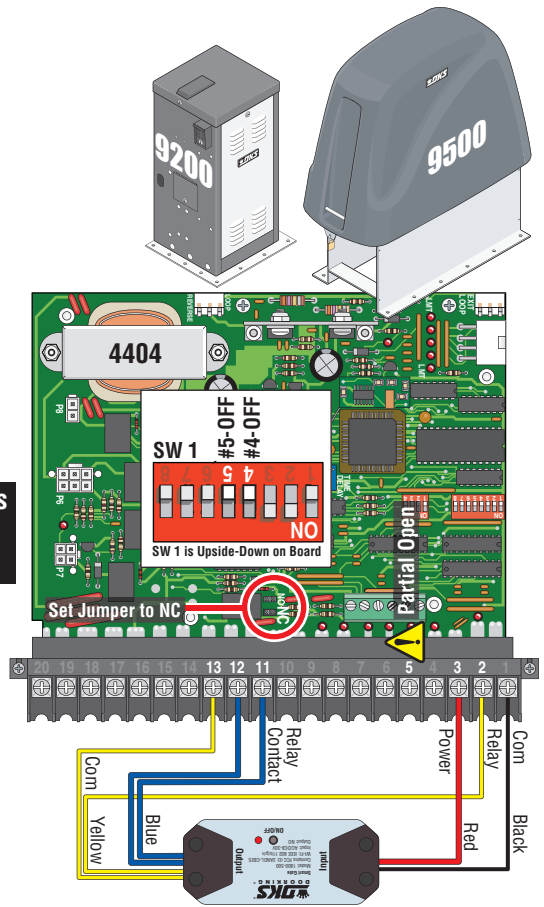

## 1601, 1602, 1603 Barrier Gate Operators

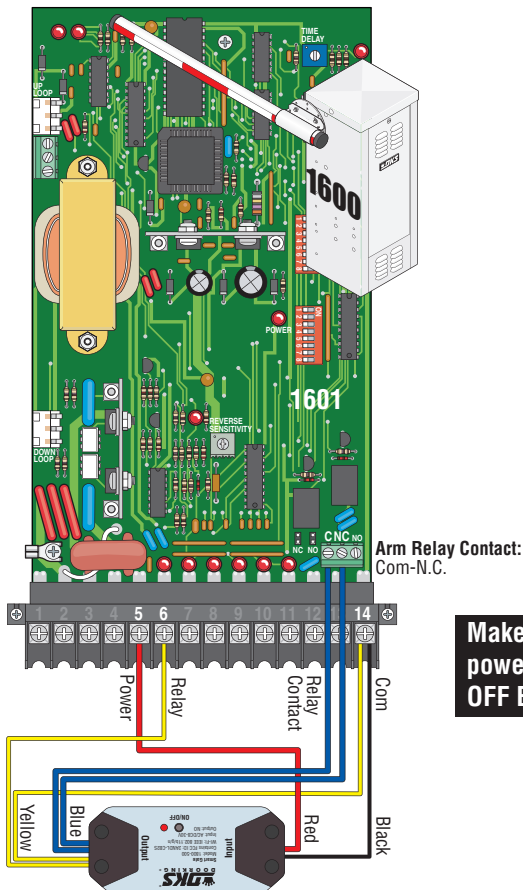

Make sure gate operator's power has been turned OFF BEFORE wiring to it.

## 1175 Overhead Gate Operator

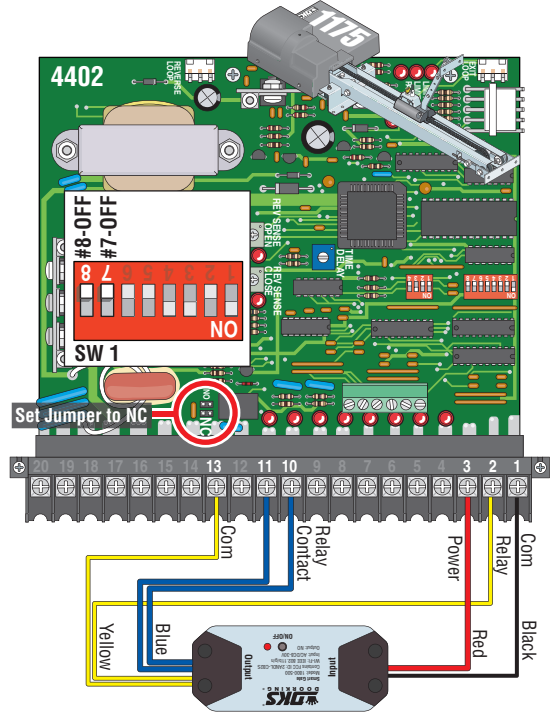



# DKS Smart Connect App

## Function Description of the Operation Interface

- Select your added device to control your gate or to edit:

### Main Screen

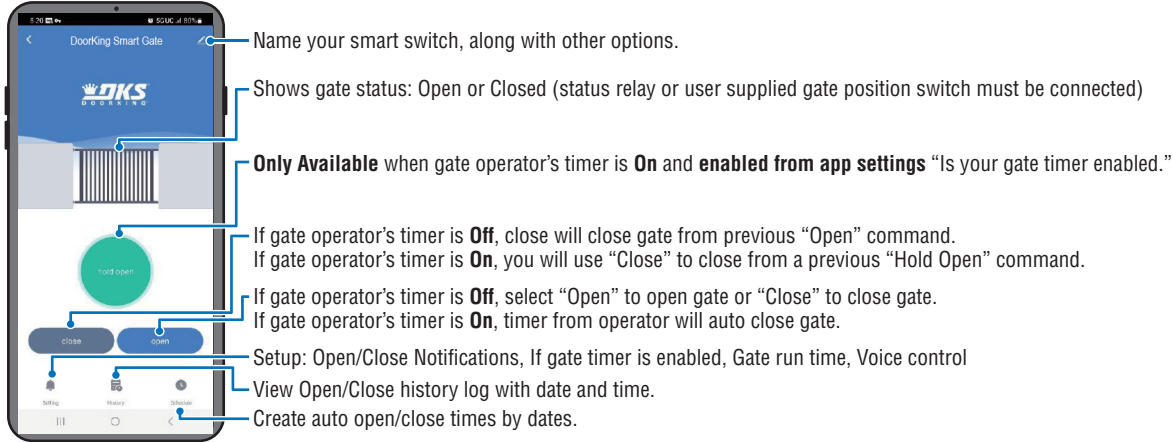

## Edit name and other options:

- Select to make adjustment as described below.

**NOTE:** These items are only available when logged in as the **PRIMARY** user.

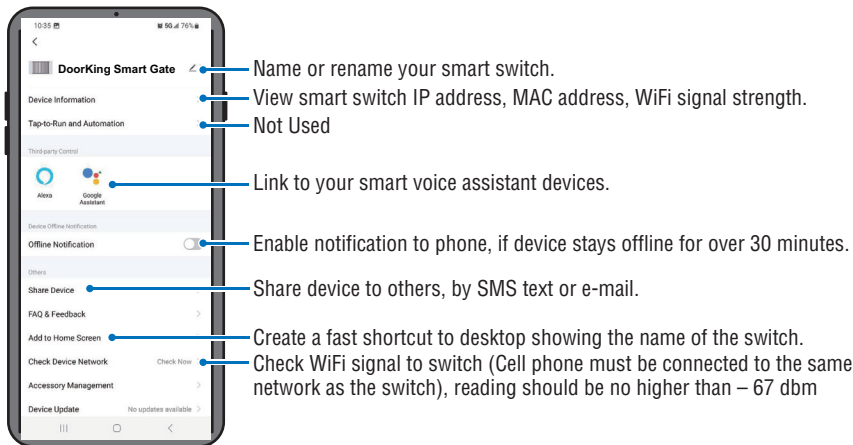

- Device can be removed from here.

## Settings:

- Select to make adjustment as described below.

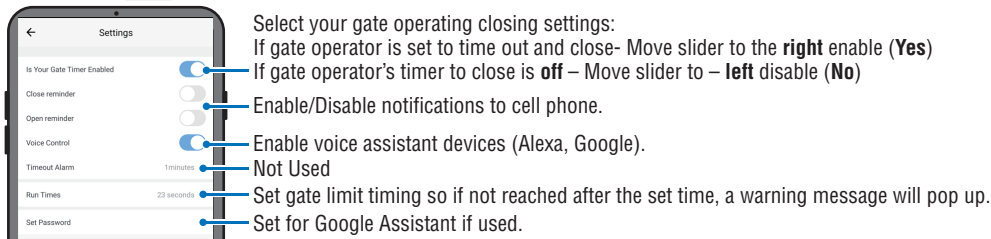

## History:

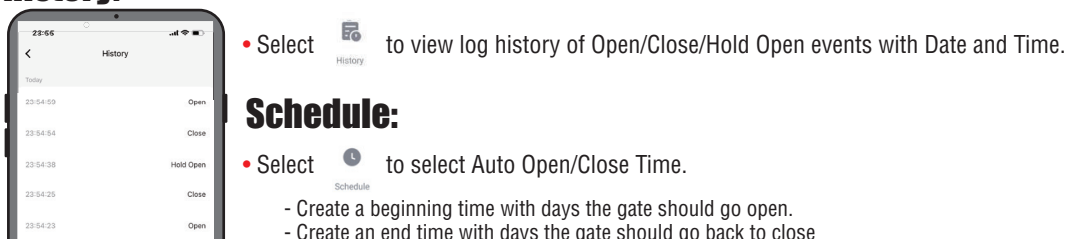

## Schedule:

- Select to select Auto Open/Close Time.
  - Create a beginning time with days the gate should go open.
  - Create an end time with days the gate should go back to close

# Link DKS Smart Connect account to Alexa

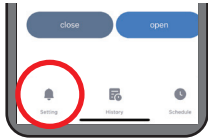

**Before** Linking DKS Smart Connect to **Alexa**:

- Launch DKS Smart Connect App, tap “**DoorKing Smart Gate**”.
- Tap the **Ring Bell** in the bottom **LEFT** corner.

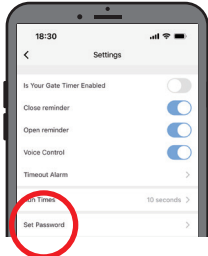

- Tap “**Set Password**”.
- Enter a Password, then tap “**Confirm**”.

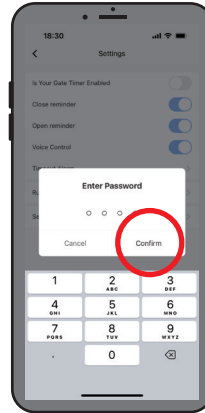

**1** Launch Amazon Alexa app and tap **More**....

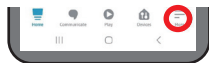

Then tap **Skills & Games** and search for **Smart Life**...



Select the skill, then Enable To Use and “**Agree and Link**”.

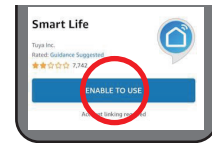

**2** Enter the e-mail used when installing DKS Smart Connect, select **Next Step** from the option of apps.

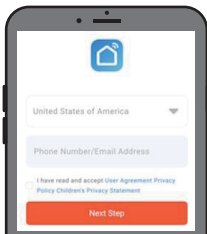

Select **DKS Smart** then select **Link Devices** for this App Account.

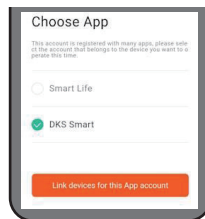

You will be prompted to enter the **password** you setup originally when installing DKS Smart Connect. Select **Next Step**, then select **Authorize**. Select **Close**, Alexa will start looking for devices to connect. This will take from seconds to minutes, once complete select close.

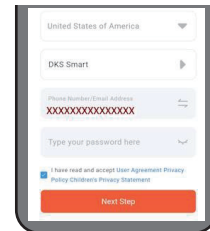

**3** You will be asked to create a **4-digit code**, enter the same 4 digit-code you created from **DKS Smart Connect**, select **Next**.

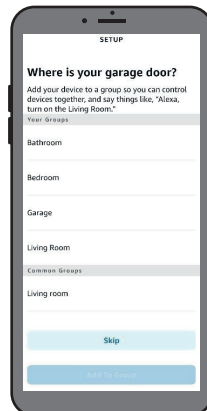
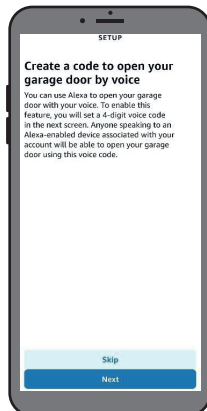

Enter your Amazon account password. Select **Next** to complete “**open by voice setup**”. At this point will have the option to organize your device to a group, or select **Skip**, then **Done**.

**NOTE:** If Alexa responds that it cannot open multiple devices, delete one of the multiple devices.

# Link DKS Smart Connect account to Google Home

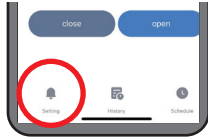

**Before** Linking DKS Smart Connect to **Google Home**:

- Launch DKS Smart Connect App, tap “**DoorKing Smart Gate**”.
- Tap the **Ring Bell** in the bottom **LEFT** corner.

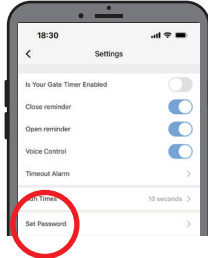

• Tap “**Set Password**”.

• Enter a Password, then tap “**Confirm**”.

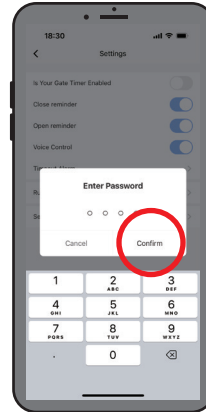

**1** Launch **Google Home** app....



**Devices-Add Device**....

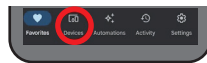

Tap on **Works with Google**.

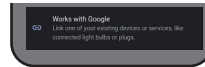

**2** Tap on to type and search....  
“**Smart Life**”

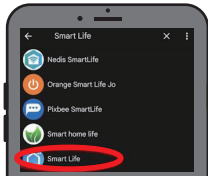

Enter the email you setup or used from the **DoorKing Smart Connect** app....

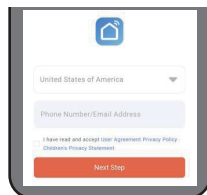

A list of apps will be listed, select **DKS Smart**, Then tap **Link devices for this App account**....

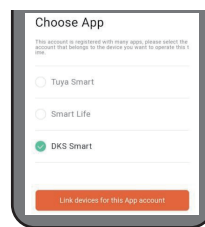

Enter the e-mail passwords then select **Next Step**.

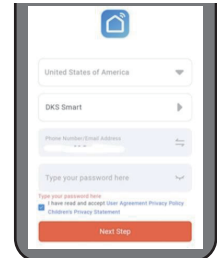

**3** Tap on **Authorize** to allow linking permission....



Select **DoorKing Smart Gate** or the **name you setup for the device**, then select **Add to room**....

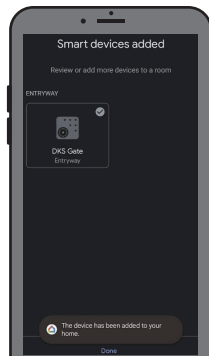

You can then select any room from the list or add one, select **Next**, You are now finish, select **Done**, close Google Home.

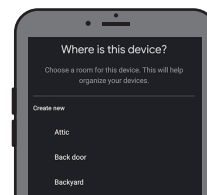



# Set Up Siri to Control the DoorKing Smart Gate

**Siri can only be used when logged as primary user**

Log in the “DKS Smart Connect” app:

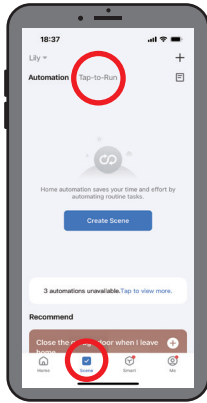

Select “Scene” at the bottom.

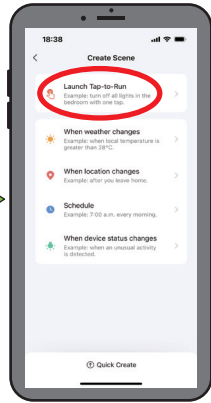

Tap “+”. Select “Launch Tap To Run”.

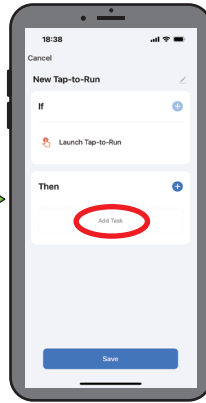

Select “Add Task”.

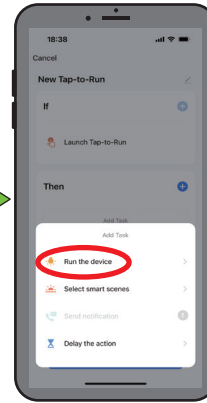

Select “Run the device”.

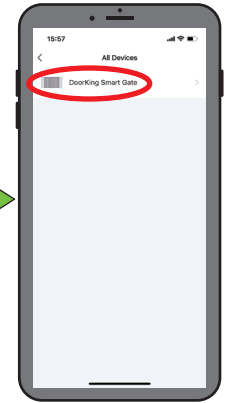

Select “DoorKing Smart Gate (Default device name)”, then select “Action”, then select “Open” or “Close”. Click “Save”, Click “Next”, and click “Save” again (please note Siri cannot support control “Hold Open”).



Go back to “Scene” page, tap on “Add to Siri”.

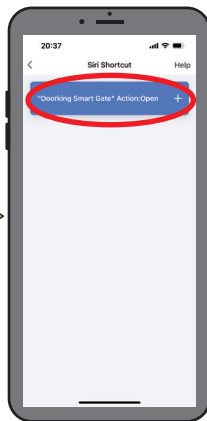

Select the tab “DoorKing Smart Gate”, action: Open or Close.

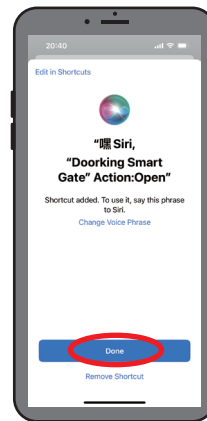

Select “Done”. Now you can say “the magic word” to control the DoorKing Smart Gate.